



**THE DATASHEET OF  
QBLP615-Y**



# **QT-Brightek Chip LED Series**

## **SMD 1206 Sideview LED**

**Part No.: QBLP615 series**

Product: QBLP615_series	Date: September 29, 2022	Page 1 of 13
	Version# 1.4	

---

**Table of Contents:**

Introduction .....	3
Electrical / Optical Characteristic (Ta=25 °C) .....	4
Absolute Maximum Rating .....	4
Characteristic Curves.....	7
Solder Profile & Footprint.....	9
Packing .....	11
Labeling .....	12
Ordering Information .....	12
Revision History .....	13
Disclaimer .....	13

## Introduction

### Feature:

- Water clear lens
- Package in tape and reel
- Side View Ultra bright 1206 LED package
- InGaN technology for IB/IG
- AlInGaP technology for R/AG/Y/S/O
- Viewing angle 150° typ.

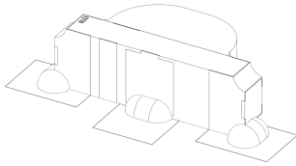

### Description:

These ultra bright side view 1206 LEDs have a height profile of 1.0mm. With higher packing density and smaller footprint, these LEDs are ideal for smaller equipment and miniature application.

### Application:

- Status indication
- Back lighting application
- General Use

### Certification & Compliance:

- TS16949
- ISO9001
- RoHS Compliant



### Dimension:

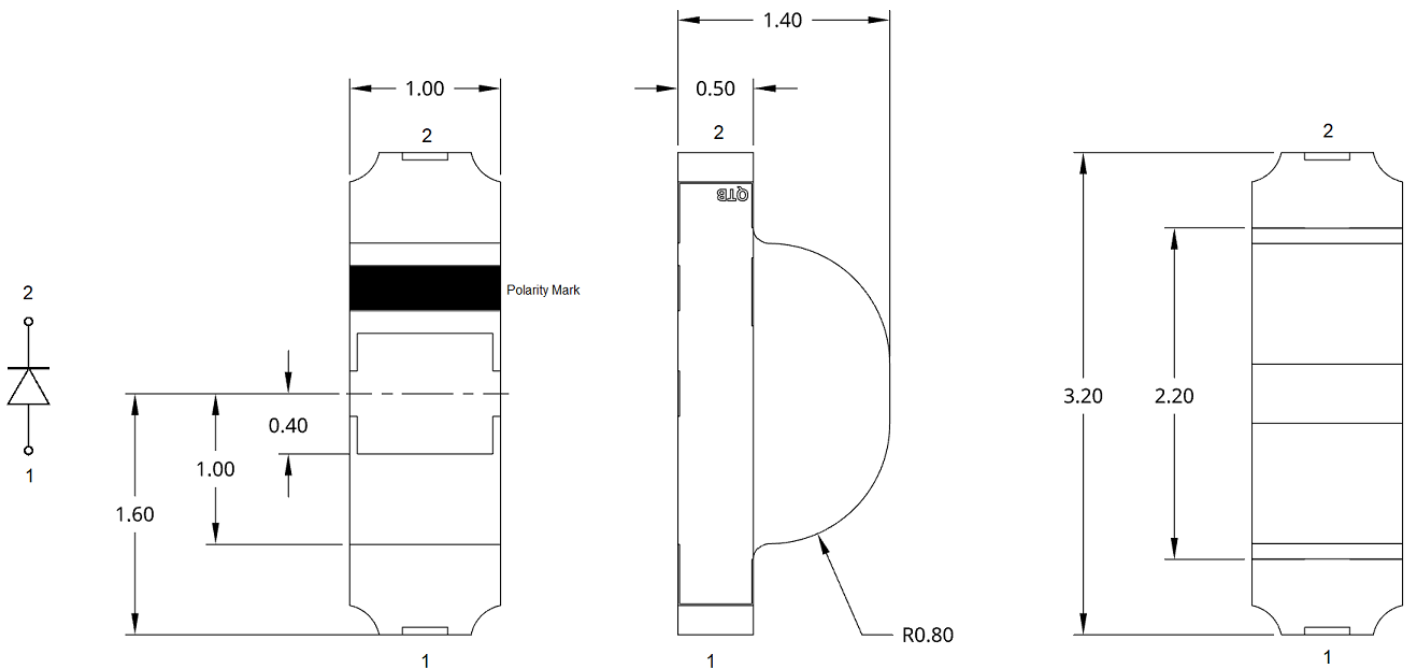

Units: mm / tolerance = +/-0.1mm

**Electrical / Optical Characteristic (Ta=25 °C)**

Product	Color	I <sub>F</sub> (mA)	V <sub>F</sub> (V)		λ <sub>D</sub> (nm)			I <sub>V</sub> (mcd)	
			Typ.	Max.	Min.	Typ.	Max.	Min.	Typ.
QBLP615-IB	Blue	20	3.1	3.7	455	460	465	40	70
QBLP615-IG	True Green	20	3.1	3.7	520	525	530	125	320
QBLP615-R	Red	20	2.0	2.5	615	620	630	80	140
QBLP615-AG	Yellow Green	20	2.0	2.5	565	570	576	20	63
QBLP615-Y	Yellow	20	2.0	2.5	585	590	595	63	120
QBLP615-O	Orange	20	2.0	2.5	600	605	610	80	150
QBLP615-S	Deep Red	20	2.0	2.5	625	630	635	50	85

**Absolute Maximum Rating**

Material	P <sub>d</sub> (mW)	I <sub>F</sub> (mA)	I <sub>FP</sub> (mA)*	V <sub>R</sub> (V)	T <sub>OP</sub> (°C)	T <sub>ST</sub> (°C)	T <sub>SOL</sub> (°C)**
InGaN (IB/IG)	111	30	125	5	-40 ~ +80	-40 ~ +85	260
AllnGaP (R/AG/Y/O/S)	75	30	125	5	-40 ~ +80	-40 ~ +85	260

\*Duty 1/8 @ 1kHz

\*\*IR Reflow for no more than 10 sec @ 260 °C

**Forward Voltage V<sub>F</sub> for AllnGaP @ I<sub>F</sub>=20mA**

Bin	Min.	Max.	Unit
□	1.7	2.5	V

**Forward Voltage V<sub>F</sub> for InGaN @ I<sub>F</sub>=20mA**

Bin	Min.	Max.	Unit
f	2.8	3.1	V
g	3.1	3.4	
h	3.4	3.7	

**Luminous Intensity  $I_V$  @  $I_F=20mA$** 

Bin	Min.	Max.	Unit
C	20	25	mcd
D	25	32	
E	32	40	
F	40	50	
G	50	63	
H	63	80	
I	80	100	
J	100	125	
K	125	160	
L	160	200	
M	200	250	
N	250	320	
O	320	400	
P	400	500	
Q	500	630	

**Dominant Wavelength  $\lambda_D$  for Blue @  $I_F=20mA$** 

Bin	Min.	Max.	Unit
C	455	457.5	nm
D	457.5	460	
E	460	462.5	
F	462.5	465	

**Dominant Wavelength  $\lambda_D$  for True Green @  $I_F=20mA$** 

Bin	Min.	Max.	Unit
U	520	522.5	nm
V	522.5	525	
W	525	527.5	
X	527.5	530	

**Dominant Wavelength  $\lambda_D$  for Red @  $I_F=20mA$** 

Bin	Min.	Max.	Unit
s	615	620	nm
t	620	625	
u	625	630	

**Dominant Wavelength  $\lambda_D$  for Yellow Green @  $I_F=20\text{mA}$** 

Bin	Min.	Max.	Unit
h	565	568	nm
i	568	572	
j	572	576	

**Dominant Wavelength  $\lambda_D$  for Yellow @  $I_F=20\text{mA}$** 

Bin	Min.	Max.	Unit
m	585	590	nm
n	590	595	

**Dominant Wavelength  $\lambda_D$  for Orange @  $I_F=20\text{mA}$** 

Bin	Min.	Max.	Unit
p	600	605	nm
q	605	610	

**Dominant Wavelength  $\lambda_D$  for Red @  $I_F=20\text{mA}$** 

Bin	Min.	Max.	Unit
u	625	630	nm
v	630	635	

**Characteristic Curves**

AllnGaP (R/AG/Y/O/S)

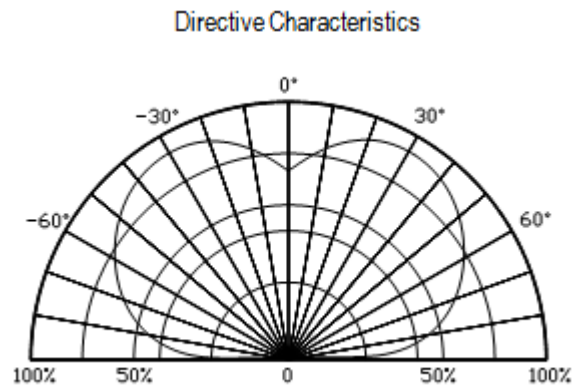
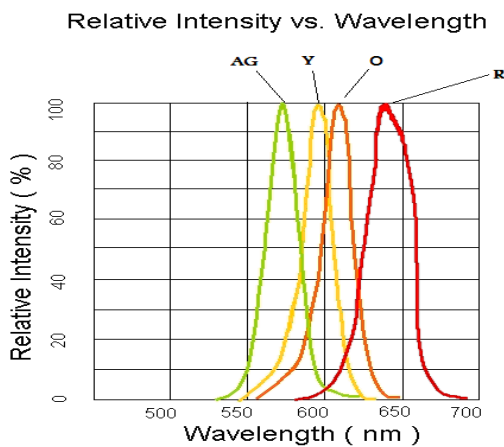
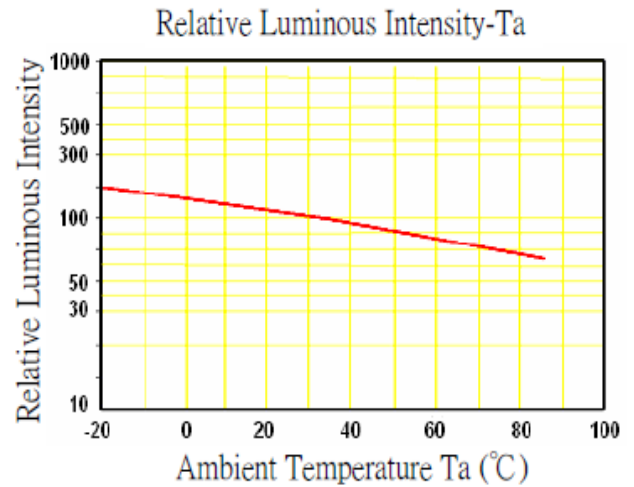
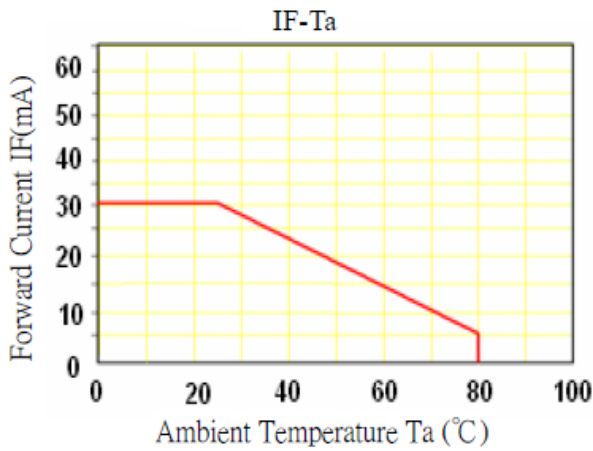
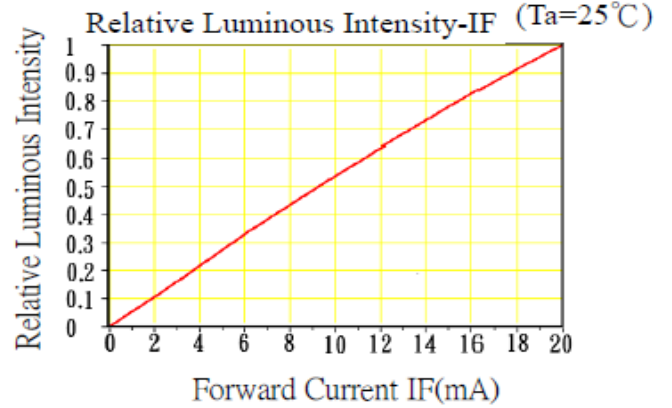
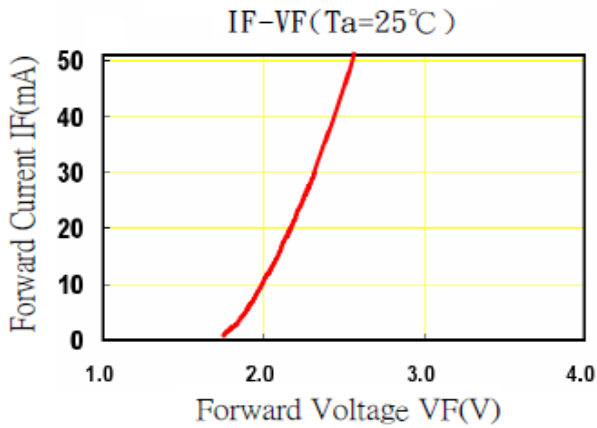

InGaN (IB/IG/IW)

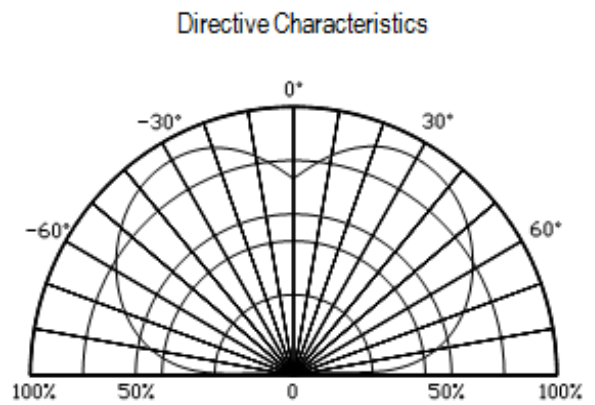
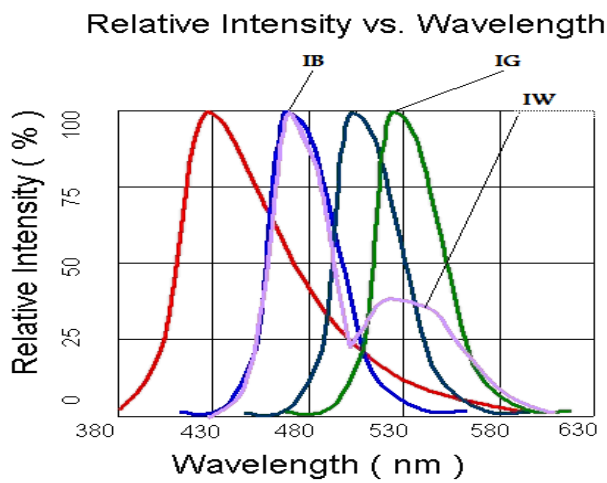
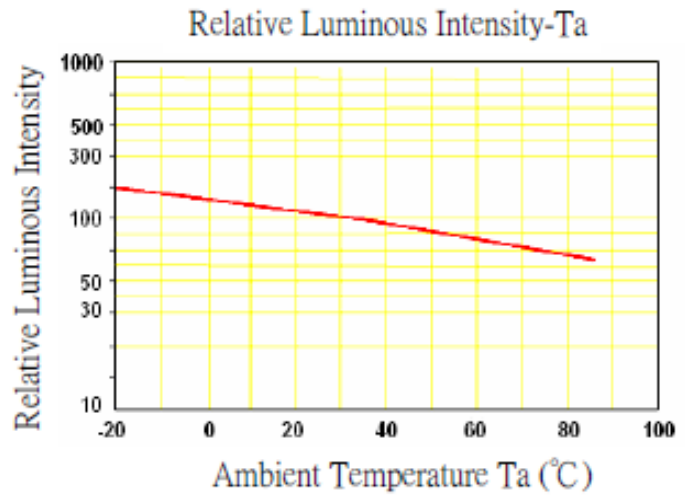
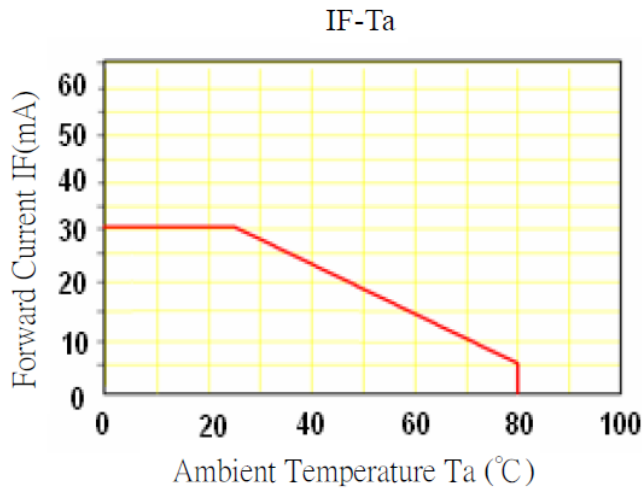
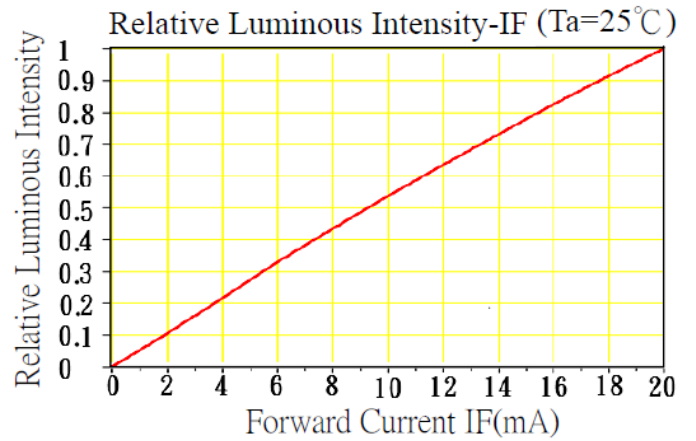
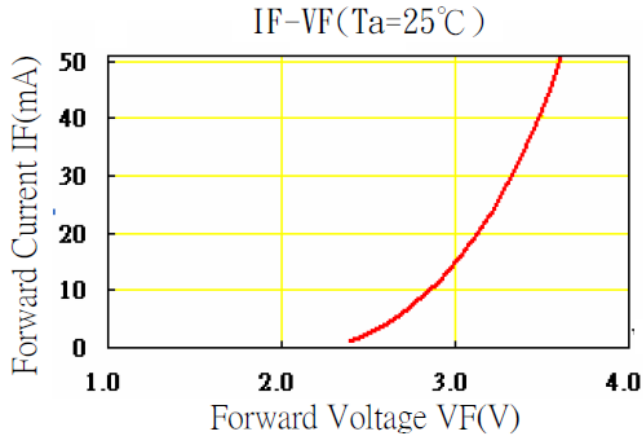

## Solder Profile & Footprint

- Recommended tin solder specifications: melting temperature in the range of 178~192 °C
- The recommended reflow soldering profile is as follows (temperatures indicated are as measured on the surface of the LED resin):

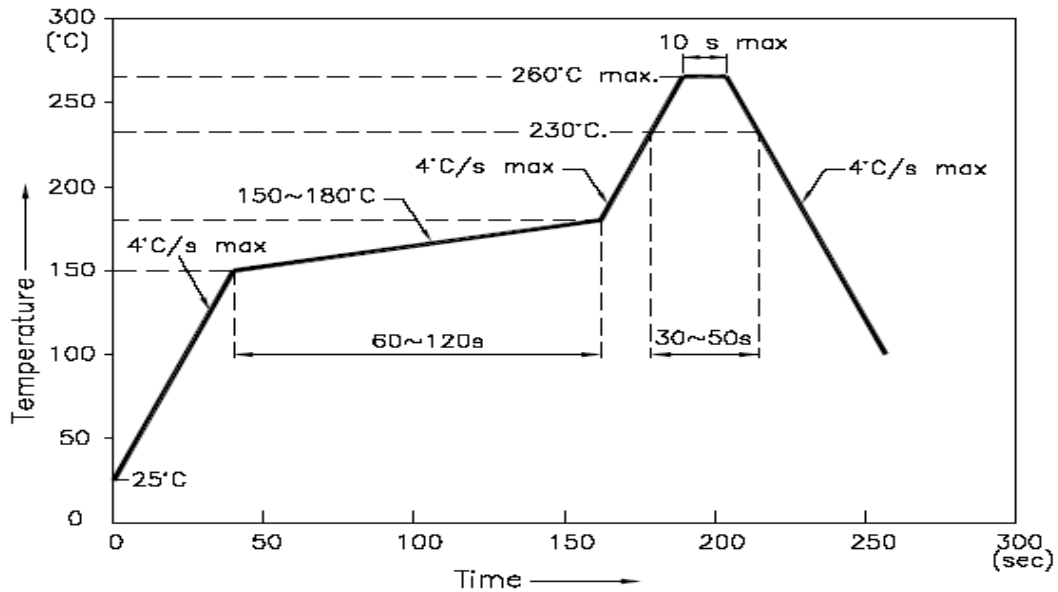

### Recommended Pad Layout

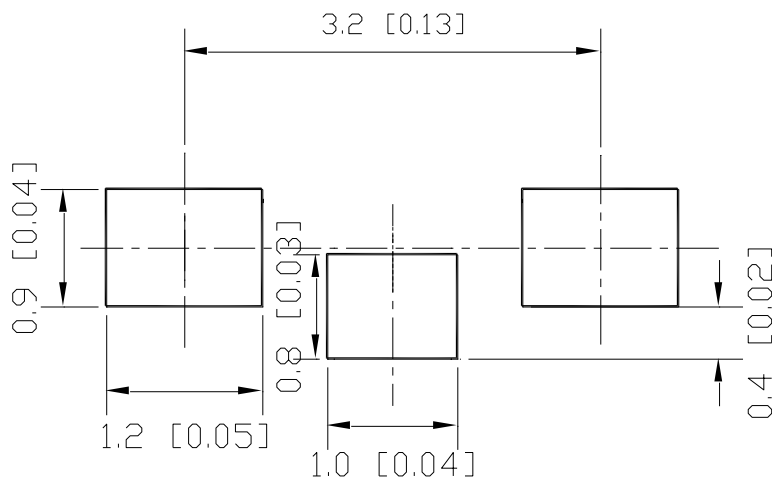

Units: mm

- The recommended IR reflow direction for a right angle (side view) SMD led is illustrated below to insure the solder on each lead melts simultaneously during the SMT reflow soldering process.

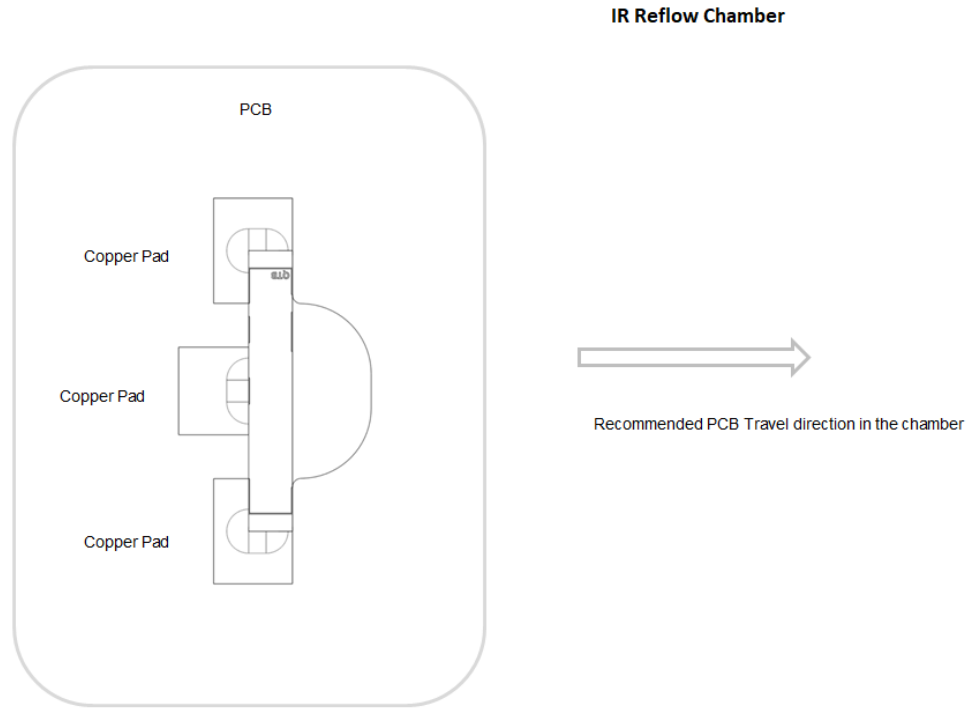

## Mounting the LED on PCB

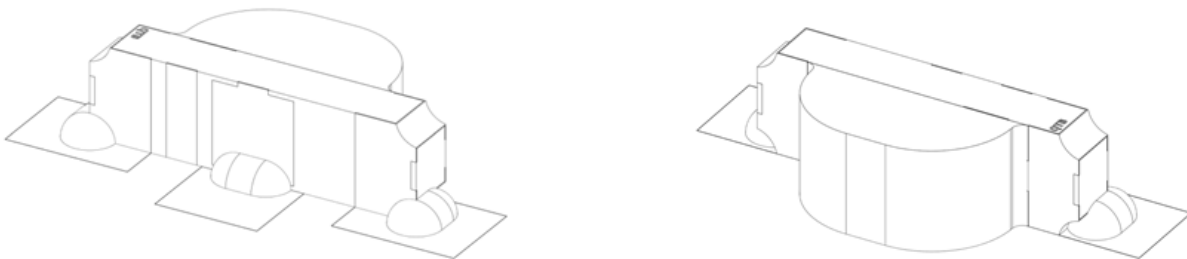

Note: The amount of solder paste applied as shown in the picture is just for illustration purpose only. When mounting and soldering the LEDs, avoid excess solder paste from overflowing onto or near the epoxy lens.

## Packing

### Reel Dimension:

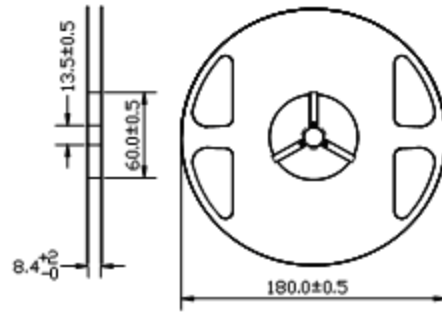

Unit: mm

### Tape Dimension:

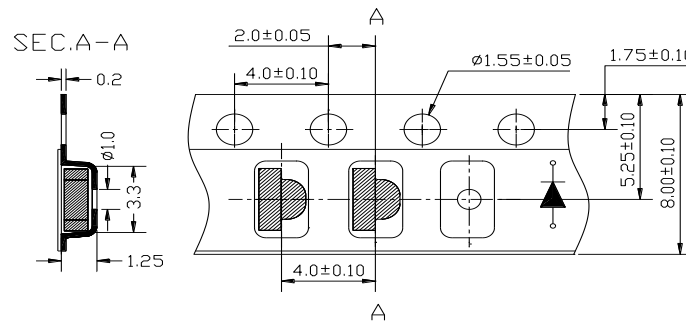

Unit: mm

### Arrangement of Tape:

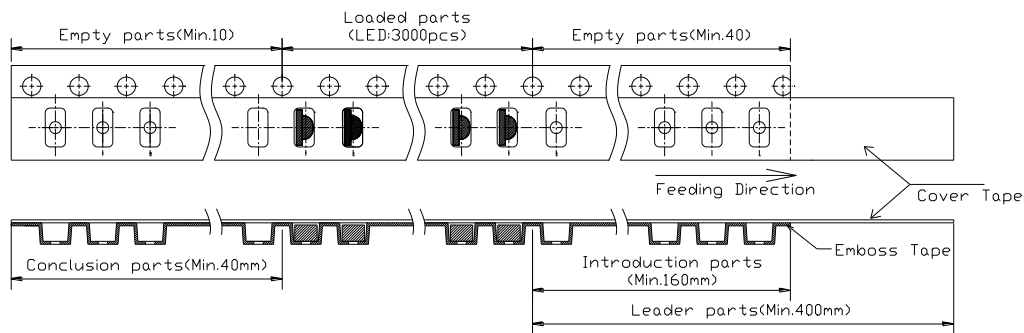

### Packaging Specifications:

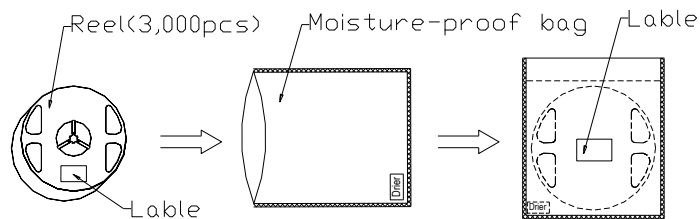

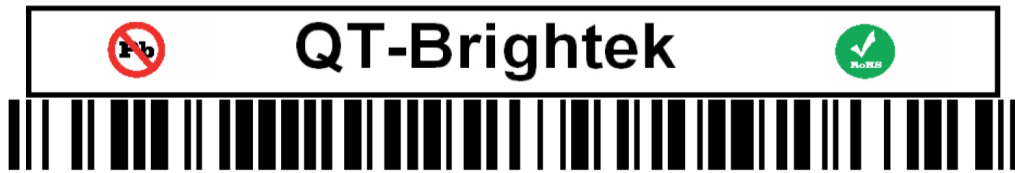
**Labeling**

**Part No:** \_\_\_\_\_  
**Customer P/N:** \_\_\_\_\_  
**Item:** \_\_\_\_\_  
**Q'ty:** \_\_\_\_\_  
**Vf:** \_\_\_\_\_  
**Iv:** \_\_\_\_\_  
**WI:** \_\_\_\_\_  
**Date:** \_\_\_\_\_

**Made in China****Ordering Information**

Part #	Orderable Part #	Spec Range	Quantity per reel
QBLP615-IB	QBLP615-IB	Iv=70mcd typ. @ 20mA / Color=455nm ~ 465nm	3,000 units
QBLP615-IG	QBLP615-IG	Iv=320 mcd typ. @ 20mA / Color=520nm ~ 530nm	3,000 units
QBLP615-R	QBLP615-R	Iv=140mcd typ. @ 20mA / Color=615nm ~ 630nm	3,000 units
QBLP615-AG	QBLP615-AG	Iv=63mcd typ. @ 20mA / Color=565nm ~ 576nm	3,000 units
QBLP615-Y	QBLP615-Y	Iv=120mcd typ. @ 20mA / Color=585nm ~ 595nm	3,000 units
QBLP615-O	QBLP615-O	Iv=150 mcd typ. @ 20mA / Color=600nm ~ 610nm	3,000 units
QBLP615-S	QBLP615-S	Iv=85 mcd typ. @ 20mA / Color=625nm ~ 635nm	3,000 units

## Revision History

Description:	Revision #	Revision Date
New Release of QBLP615_series	V1.0	06/25/2011
Amend drawing and footprint	V1.1	11/28/2011
Amend new format/ drawings/ update spec of blue/ red/ orange/ Yellow/ Add Deep Red spec	V1.2	11/18/2013
Update solder Profile and characteristic curve, add viewing angle	V1.3	02/04/2014
Add recommended SMT and mounting suggestion / Optimize drawing dimensions in the datasheet	V1.4	09/29/2022

## Disclaimer

QT-BRIGHTTEK reserves the right to make changes without further notice to any products herein to improve reliability, function or design. QT-BRIGHTTEK does not assume any liability arising out of the application or use of any product or circuit described herein; neither does it convey any license under its patent rights, nor the rights of others.



## Life Support Policy

QT-BRIGHTTEK's products are not authorized for use as critical components in life support devices or systems without the express written approval of QT-BRIGHTTEK. As used herein:

1. Life support devices or systems are devices or systems which, (a) are intended for surgical implant into the body, or (b) support or sustain life, and (c) whose failure to perform when properly used in accordance with instructions for use provided in the labeling, can be reasonably expected to result in a significant injury of the user.
2. A critical component in any component of a life support device or system whose failure to perform can be reasonably expected to cause the failure of the life support device or system, or to affect its safety or effectiveness.

## Looking for pricing, stock, or lifecycle information?

Click below to explore more details on WIN SOURCE:

-  [View QBLP615-Y on WIN SOURCE](#)
-  [QT Brightek \(QTB\) Information](#)

## Optimize Your Supply Chain with WIN SOURCE Solutions

-  Global Sourcing Solution
-  Obsolete Management
-  Cost Control Management
-  Shortage Management
-  Alternative Solution
-  Excess Inventory Management