



**THE DATASHEET OF  
LT1990AHS8#TRPBF**



# ±250V Input Range G = 1, 10, Micropower, Difference Amplifier

## FEATURES

- Pin Selectable Gain of 1 or 10
- High Common Mode Voltage Range:  
 85V Window ( $V_S = 5V, 0V$ )  
 $\pm 250V$  ( $V_S = \pm 15V$ )
- Common Mode Rejection Ratio: 70dB Min
- Input Protection to  $\pm 350V$
- Gain Error: 0.28% Max
- PSRR: 82dB Min
- High Input Impedance:  $2M\Omega$  Differential,  
 $500k\Omega$  Common Mode
- Micropower:  $120\mu A$  Max Supply Current
- Wide Supply Range: 2.7V to 36V
- -3dB Bandwidth: 100kHz
- Rail-to-Rail Output
- 8-Pin SO Package

## APPLICATIONS

- Battery Cell Voltage Monitoring
- High Voltage Current Sensing
- Signal Acquisition in Noisy Environments
- Input Protection
- Fault Protected Front Ends
- Level Sensing
- Isolation

## DESCRIPTION

The LT<sup>®</sup>1990 is a micropower precision difference amplifier with a very high common mode input voltage range. It has pin selectable gains of 1 or 10. The LT1990 operates over a  $\pm 250V$  common mode voltage range on a  $\pm 15V$  supply. The inputs are fault protected from common mode voltage transients up to  $\pm 350V$  and differential voltages up to  $\pm 500V$ . The LT1990 is ideally suited for both high side and low side current or voltage monitoring.

On a single 5V supply, the LT1990 has an adjustable 85V input range, 70dB min CMRR and draws less than  $120\mu A$  supply current. The rail-to-rail output maximizes the dynamic range, especially important for single supplies as low as 2.7V.

The LT1990 is specified for single 3V, 5V and  $\pm 15V$  supplies over both commercial and industrial temperature ranges. The LT1990 is available in the 8-pin SO package.

LT, LT, LTC and LTM are registered trademarks of Linear Technology Corporation. All other trademarks are the property of their respective owners.

## TYPICAL APPLICATION

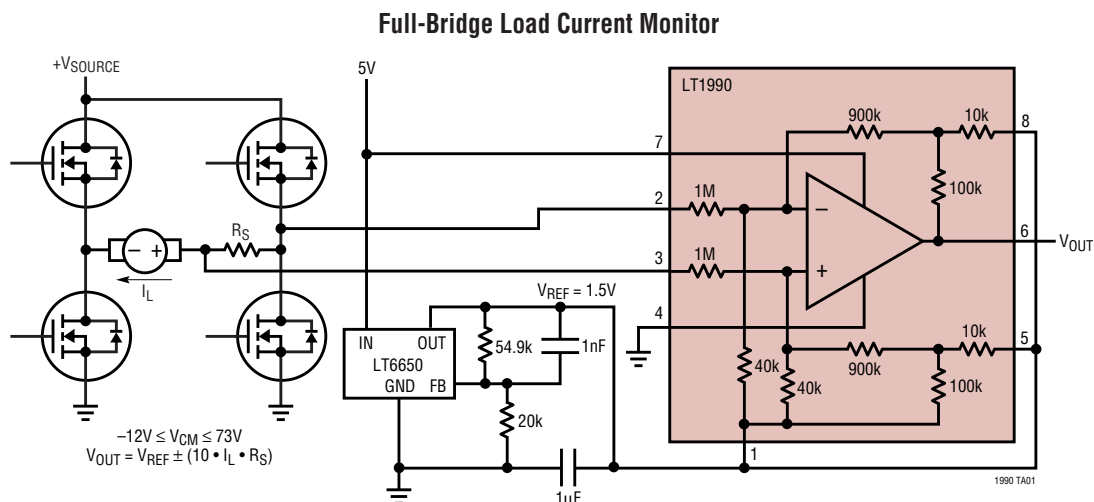

**ABSOLUTE MAXIMUM RATINGS**

(Notes 1, 2)

Total Supply Voltage ( $V^+$ to $V^-$ ) .....	36V
Input Voltage Range	
Continuous .....	$\pm 250V$
Transient (0.1s) .....	$\pm 350V$
Differential .....	$\pm 500V$
Output Short-Circuit Duration (Note 3) .....	Indefinite
Operating Temperature Range (Note 4)	
LT1990C .....	$-40^\circ C$ to $85^\circ C$
LT1990I .....	$-40^\circ C$ to $85^\circ C$
LT1990H .....	$-40^\circ C$ to $125^\circ C$
Specified Temperature Range (Note 5)	
LT1990C .....	$-40^\circ C$ to $85^\circ C$
LT1990I .....	$-40^\circ C$ to $85^\circ C$
LT1990H .....	$-40^\circ C$ to $125^\circ C$
Junction Temperature .....	$150^\circ C$
Storage Temperature Range .....	$-65^\circ C$ to $150^\circ C$
Lead Temperature (Soldering, 10 sec.) .....	$300^\circ C$

**PACKAGE/ORDER INFORMATION**

TOP VIEW

S8 PACKAGE  
8-LEAD PLASTIC SO  
 $T_{JMAX} = 150^\circ C, \theta_{JA} = 190^\circ C/W$

ORDER PART NUMBER	S8 PART MARKING
LT1990CS8	1990
LT1990IS8	1990I
LT1990HS8	1990H
LT1990ACS8	1990A
LT1990AIS8	1990AI
LT1990AHS8	1990AH

**Order Options** Tape and Reel: Add #TR  
Lead Free: Add #PBF Lead Free Tape and Reel: Add #TRPBF  
Lead Free Part Marking: <http://www.linear.com/leadfree/>

Consult LTC Marketing for parts specified with wider operating temperature ranges.

**3V/5V ELECTRICAL CHARACTERISTICS**

$V_S = 3V, 0V; V_S = 5V, 0V; R_L = 10k, V_{CM} = V_{REF} = \text{half supply}, G = 1, 10, T_A = 25^\circ C$ , unless otherwise noted. (Note 6)

SYMBOL	PARAMETER	CONDITIONS	MIN	TYP	MAX	UNITS
G	Gain	Pins 5 and 8 = Open Pins 5 and 8 = $V_{REF}$		1 10		
$\Delta G$	Gain Error	$V_{OUT} = 0.5V$ to $(+V_S) - 0.75V$ LT1990, $G = 1$ LT1990A, $G = 1$ $G = 10, V_S = 5V, 0V$		0.4 0.07 0.2	0.6 0.28 0.8	% % %
GNL	Gain Nonlinearity	$V_S = 5V, 0V; V_{OUT} = 0.5V$ to $4.25V$ $G = 1$ $G = 10$		0.001 0.01	0.005	% %
$V_{CM}$	Input Voltage Range	Guaranteed by CMRR $V_S = 3V, 0V; V_{REF} = 1.25V$ $V_S = 5V, 0V; V_{REF} = 1.25V$ $V_S = 5V, 0V; V_{REF} = 2.5V$	-5 -5 -38		25 80 47	V V V
CMRR	Common Mode Rejection Ratio RTI (Referred to Input)	$V_S = 3V, 0V$ (Note 7) $V_{CM} = -5V$ to $25V, V_{REF} = 1.25V$ LT1990 LT1990A	60 70	68 75		dB dB
		$V_S = 5V, 0V$ $V_{CM} = -5V$ to $80V, V_{REF} = 1.25V$ LT1990 LT1990A	60 70	68 75		dB dB
		$V_S = 5V, 0V$ (Note 7) $V_{CM} = -38V$ to $47V, V_{REF} = 2.5V$ LT1990 LT1990A	60 70	68 75		dB dB

### 3V/5V ELECTRICAL CHARACTERISTICS

$V_S = 3V, 0V; V_S = 5V, 0V; R_L = 10k, V_{CM} = V_{REF} = \text{half supply}, G = 1, 10, T_A = 25^\circ C$ , unless otherwise noted. (Note 6)

SYMBOL	PARAMETER	CONDITIONS	MIN	TYP	MAX	UNITS
$V_{OS}$	Offset Voltage, RTI	$G = 1, 10$		0.8	3	mV
$e_n$	Input Noise Voltage, RTI	$f_0 = 0.1\text{Hz to }10\text{Hz}$		22		$\mu V_{P-P}$
	Noise Voltage Density, RTI	$f_0 = 1\text{kHz}$		1		$\mu V/\sqrt{\text{Hz}}$
$R_{IN}$	Input Resistance	Differential Common Mode		2 0.5		$M\Omega$ $M\Omega$
PSRR	Power Supply Rejection Ratio, RTI	$V_S = 2.7V \text{ to } 12.7V, V_{CM} = V_{REF} = 1.25V$	80	92		dB
	Minimum Supply Voltage	Guaranteed by PSRR		2.4	2.7	V
$I_S$	Supply Current	(Note 8)		105	120	$\mu A$
$V_{OL}$	Output Voltage Swing LOW	$-IN = V^+, +IN = \text{Half Supply (Note 8)}$		30	50	mV
$V_{OH}$	Output Voltage Swing HIGH	$-IN = 0V, +IN = \text{Half Supply}$ $V_S = 3V, 0V, \text{Below } V^+$ $V_S = 5V, 0V, \text{Below } V^+$		100 120	150 175	mV mV
$I_{SC}$	Output Short-Circuit Current	Short to GND (Note 9) Short to $V^+$ (Note 9)	4 13	8 20		mA mA
BW	Bandwidth (-3dB)	$G = 1$ $G = 10$		100 6.5		kHz kHz
SR	Slew Rate	$G = 1, V_S = 5V, 0V, V_{OUT} = 0.5V \text{ to } 4.5V$		0.5		$V/\mu s$
	Settling Time to 0.01%	4V Step, $G = 1, V_S = 5V, 0V$		45		$\mu s$
$AV_{REF}$	Reference Gain to Output	$G = 1$ $G = 10$		$1 \pm 0.0007$ $1 \pm 0.007$		

The ● denotes the specifications which apply over the temperature range of  $0^\circ C \leq T_A \leq 70^\circ C$ .  $V_S = 3V, 0V; V_S = 5V, 0V; R_L = 10k, V_{CM} = V_{REF} = \text{half supply}, G = 1, 10$ , unless otherwise noted. (Notes 4, 6)

SYMBOL	PARAMETER	CONDITIONS	LT1990C/LT1990I			UNITS
			MIN	TYP	MAX	
$\Delta G$	Gain Error	$V_{OUT} = 0.5V \text{ to } (+V_S) - 0.75V$ LT1990, $G = 1$ ● LT1990A, $G = 1$ ● $G = 10$ ●			0.65 0.33 0.90	% % %
G/T	Gain vs Temperature	$G = 1$ (Note 10) ● $G = 10$ (Note 10) ●		2 7	10 20	ppm/°C ppm/°C
$V_{CM}$	Input Voltage Range	Guaranteed by CMRR $V_S = 3V, 0V, V_{REF} = 1.25V$ ● $V_S = 5V, 0V, V_{REF} = 1.25V$ ● $V_S = 5V, 0V, V_{REF} = 2.5V$ ●	-5 -5 -37		25 80 48	V V V
CMRR	Common Mode Rejection Ratio, RTI	$V_S = 3V, 0V$ (Note 7) $V_{CM} = -5V \text{ to } 25V, V_{REF} = 1.25V$ LT1990 ● LT1990A ●	58 68			dB dB
		$V_S = 5V, 0V$ $V_{CM} = -5V \text{ to } 80V, V_{REF} = 1.25V$ LT1990 ● LT1990A ●	58 68			dB dB
		$V_S = 5V, 0V$ (Note 7) $V_{CM} = -38V \text{ to } 47V, V_{REF} = 2.5V$ LT1990 ● LT1990A ●	58 68			dB dB

## 3V/5V ELECTRICAL CHARACTERISTICS

The ● denotes the specifications which apply over the temperature range of  $0^{\circ}\text{C} \leq T_A \leq 70^{\circ}\text{C}$ .  $V_S = 3\text{V}, 0\text{V}$ ;  $V_S = 5\text{V}, 0\text{V}$ ;  $R_L = 10\text{k}$ ,  $V_{\text{CM}} = V_{\text{REF}} = \text{half supply}$ ,  $G = 1, 10$ , unless otherwise noted. (Notes 4, 6)

SYMBOL	PARAMETER	CONDITIONS	LT1990C/LT1990I			UNITS
			MIN	TYP	MAX	
$V_{\text{OS}}$	Input Offset Voltage, RTI	$V_S = 3\text{V}, 0\text{V}$ $G = 1, 10$	●		4.1	mV
		$V_S = 5\text{V}, 0\text{V}$ $G = 1, 10$	●		4.1	mV
$V_{\text{OS/T}}$	Input Offset Voltage Drift, RTI	(Note 10)	●	5	22	$\mu\text{V}/^{\circ}\text{C}$
$V_{\text{OSH}}$	Input Offset Voltage Hysteresis, RTI	(Note 11)	●	230		$\mu\text{V}$
PSRR	Power Supply Rejection Ratio, RTI	$V_S = 2.7\text{V}$ to $12.7\text{V}$ $V_{\text{CM}} = V_{\text{REF}} = 1.25\text{V}$ $G = 1, 10$	●	78		dB
		Minimum Supply Voltage	Guaranteed by PSRR	●		2.7
$I_S$	Supply Current	(Note 8)	●		150	$\mu\text{A}$
$V_{\text{OL}}$	Output Voltage Swing LOW	$-IN = V^+$ , $+IN = \text{Half Supply}$ (Note 8)	●		60	mV
$V_{\text{OH}}$	Output Voltage Swing HIGH	$-IN = 0\text{V}$ , $+IN = \text{Half Supply}$ $V_S = 3\text{V}, 0\text{V}$ , Below $V^+$	●		180	mV
		$V_S = 5\text{V}, 0\text{V}$ , Below $V^+$	●		205	mV
$I_{\text{SC}}$	Output Short-Circuit Current	Short to GND (Note 9)	●	3		mA
		Short to $V^+$ (Note 9)	●	11		mA

The ● denotes the specifications which apply over the temperature range of  $-40^{\circ}\text{C} \leq T_A \leq 85^{\circ}\text{C}$ .  $V_S = 3\text{V}, 0\text{V}$ ;  $V_S = 5\text{V}, 0\text{V}$ ;  $R_L = 10\text{k}$ ,  $V_{\text{CM}} = V_{\text{REF}} = \text{half supply}$ ,  $G = 1, 10$ , unless otherwise noted. (Notes 4, 6)

SYMBOL	PARAMETER	CONDITIONS	LT1990C/LT1990I			UNITS
			MIN	TYP	MAX	
$\Delta G$	Gain Error	$V_{\text{OUT}} = 0.5\text{V}$ to $(+V_S) - 0.75\text{V}$ LT1990, $G = 1$	●		0.67	%
		LT1990A, $G = 1$	●		0.35	%
		$G = 10$	●		0.95	%
G/T	Gain vs Temperature	$G = 1$ (Note 10)	●	2	10	ppm/ $^{\circ}\text{C}$
		$G = 10$ (Note 10)	●	7	20	ppm/ $^{\circ}\text{C}$
$V_{\text{CM}}$	Input Voltage Range	Guaranteed by CMRR $V_S = 3\text{V}, 0\text{V}$ , $V_{\text{REF}} = 1.25\text{V}$	●	-5	25	V
		$V_S = 5\text{V}, 0\text{V}$ , $V_{\text{REF}} = 1.25\text{V}$	●	-5	80	V
		$V_S = 5\text{V}, 0\text{V}$ , $V_{\text{REF}} = 2.5\text{V}$	●	-37	48	V
CMRR	Common Mode Rejection Ratio, RTI	$V_S = 3\text{V}, 0\text{V}$ (Note 7) $V_{\text{CM}} = -5\text{V}$ to $25\text{V}$ , $V_{\text{REF}} = 1.25\text{V}$ LT1990	●	57		dB
			LT1990A	●	67	
		$V_S = 5\text{V}, 0\text{V}$ $V_{\text{CM}} = -5\text{V}$ to $80\text{V}$ , $V_{\text{REF}} = 1.25\text{V}$ LT1990	●	57		dB
			LT1990A	●	67	
		$V_S = 5\text{V}, 0\text{V}$ (Note 7) $V_{\text{CM}} = -38\text{V}$ to $47\text{V}$ , $V_{\text{REF}} = 2.5\text{V}$ LT1990	●	57		dB
			LT1990A	●	67	

### 3V/5V ELECTRICAL CHARACTERISTICS

The ● denotes the specifications which apply over the temperature range of  $-40^{\circ}\text{C} \leq T_A \leq 85^{\circ}\text{C}$ .  $V_S = 3\text{V}, 0\text{V}$ ;  $V_S = 5\text{V}, 0\text{V}$ ;  $R_L = 10\text{k}$ ,  $V_{CM} = V_{REF} = \text{half supply}$ ,  $G = 1, 10$ , unless otherwise noted. (Notes 4, 6)

SYMBOL	PARAMETER	CONDITIONS	LT1990C/LT1990I			UNITS
			MIN	TYP	MAX	
$V_{OS}$	Input Offset Voltage, RTI	$V_S = 3\text{V}, 0\text{V}$ $G = 1, 10$	●		4.5	mV
		$V_S = 5\text{V}, 0\text{V}$ $G = 1, 10$	●		4.5	mV
$V_{OS/T}$	Input Offset Voltage Drift, RTI	(Note 10)	●	5	22	$\mu\text{V}/^{\circ}\text{C}$
$V_{OSH}$	Input Offset Voltage Hysteresis, RTI	(Note 11)	●	230		$\mu\text{V}$
PSRR	Power Supply Rejection Ratio, RTI	$V_S = 2.7\text{V}$ to $12.7\text{V}$ $V_{CM} = V_{REF} = 1.25\text{V}$	●	76		dB
	Minimum Supply Voltage	Guaranteed by PSRR	●		2.7	V
$I_S$	Supply Current	(Note 8)	●		170	$\mu\text{A}$
$V_{OL}$	Output Voltage Swing LOW	$-IN = V^+$ , $+IN = \text{Half Supply}$ (Note 8)	●		70	mV
$V_{OH}$	Output Voltage Swing HIGH	$-IN = 0\text{V}$ , $+IN = \text{Half Supply}$ $V_S = 3\text{V}, 0\text{V}$ , Below $V^+$	●		200	mV
		$V_S = 5\text{V}, 0\text{V}$ , Below $V^+$	●		275	mV
$I_{SC}$	Output Short-Circuit Current	Short to GND (Note 9)	●	2		mA
		Short to $V^+$ (Note 9)	●	8		mA

### 3V/5V ELECTRICAL CHARACTERISTICS

The ● denotes the specifications which apply over the temperature range of  $-40^{\circ}\text{C} \leq T_A \leq 125^{\circ}\text{C}$ .  $V_S = 3\text{V}, 0\text{V}$ ;  $V_S = 5\text{V}, 0\text{V}$ ;  $R_L = 10\text{k}$ ,  $V_{CM} = V_{REF} = \text{half supply}$ ,  $G = 1, 10$ , unless otherwise noted. (Notes 4, 6)

SYMBOL	PARAMETER	CONDITIONS	LT1990H			UNITS
			MIN	TYP	MAX	
$\Delta G$	Gain Error	$V_{OUT} = 0.5\text{V}$ to $(+V_S) - 0.75\text{V}$ LT1990, $G = 1$	●		0.69	%
		LT1990A, $G = 1$	●		0.37	%
		$G = 10$	●		0.97	%
G/T	Gain vs Temperature	$G = 1$ (Note 10)	●	2	10	ppm/ $^{\circ}\text{C}$
		$G = 10$ (Note 10)	●	7	20	ppm/ $^{\circ}\text{C}$
$V_{CM}$	Input Voltage Range	Guaranteed by CMRR $V_S = 3\text{V}, 0\text{V}$ , $V_{REF} = 1.25\text{V}$	●	-5	25	V
		$V_S = 5\text{V}, 0\text{V}$ , $V_{REF} = 1.25\text{V}$	●	-5	80	V
		$V_S = 5\text{V}, 0\text{V}$ , $V_{REF} = 2.5\text{V}$	●	-37	48	V
CMRR	Common Mode Rejection Ratio, RTI	$V_S = 3\text{V}, 0\text{V}$ (Note 7) $V_{CM} = -5\text{V}$ to $25\text{V}$ , $V_{REF} = 1.25\text{V}$ LT1990	●	56		dB
		LT1990A	●	66		dB
		$V_S = 5\text{V}, 0\text{V}$ $V_{CM} = -5\text{V}$ to $80\text{V}$ , $V_{REF} = 1.25\text{V}$ LT1990	●	56		dB
		LT1990A	●	66		dB
		$V_S = 5\text{V}, 0\text{V}$ (Note 7) $V_{CM} = -38\text{V}$ to $47\text{V}$ , $V_{REF} = 2.5\text{V}$ LT1990	●	56		dB
		LT1990A	●	66		dB

## 3V/5V ELECTRICAL CHARACTERISTICS

The ● denotes the specifications which apply over the temperature range of  $-40^{\circ}\text{C} \leq T_A \leq 125^{\circ}\text{C}$ .  $V_S = 3\text{V}, 0\text{V}$ ;  $V_S = 5\text{V}, 0\text{V}$ ;  $R_L = 10\text{k}$ ,  $V_{\text{CM}} = V_{\text{REF}} = \text{half supply}$ ,  $G = 1, 10$ , unless otherwise noted. (Notes 4, 6)

SYMBOL	PARAMETER	CONDITIONS	LT1990H			UNITS
			MIN	TYP	MAX	
$V_{\text{OS}}$	Input Offset Voltage, RTI	$V_S = 3\text{V}, 0\text{V}$ $G = 1, 10$	●		5.2	mV
		$V_S = 5\text{V}, 0\text{V}$ $G = 1, 10$	●		5.2	mV
$V_{\text{OS/T}}$	Input Offset Voltage Drift, RTI	(Note 10)	●	5	22	$\mu\text{V}/^{\circ}\text{C}$
$V_{\text{OSH}}$	Input Offset Voltage Hysteresis, RTI	(Note 11)	●	250		$\mu\text{V}$
PSRR	Power Supply Rejection Ratio, RTI	$V_S = 2.7\text{V}$ to $12.7\text{V}$ $V_{\text{CM}} = V_{\text{REF}} = 1.25\text{V}$	●	75		dB
	Minimum Supply Voltage	Guaranteed by PSRR	●		2.7	V
$I_S$	Supply Current	(Note 8)	●		200	$\mu\text{A}$
$V_{\text{OL}}$	Output Voltage Swing LOW	$-IN = V^+$ , $+IN = \text{Half Supply}$ (Note 8)	●		80	mV
$V_{\text{OH}}$	Output Voltage Swing HIGH	$-IN = 0\text{V}$ , $+IN = \text{Half Supply}$ $V_S = 3\text{V}, 0\text{V}$ , Below $V^+$	●		230	mV
		$V_S = 5\text{V}, 0\text{V}$ , Below $V^+$	●		275	mV
$I_{\text{SC}}$	Output Short-Circuit Current	Short to GND (Note 9)	●	1		mA
		Short to $V^+$ (Note 9)	●	5		mA

## $\pm 15\text{V}$ ELECTRICAL CHARACTERISTICS

$V_S = \pm 15\text{V}$ ,  $R_L = 10\text{k}$ ,  $V_{\text{CM}} = V_{\text{REF}} = 0\text{V}$ ,  $G = 1, 10$ ,  $T_A = 25^{\circ}\text{C}$ , unless otherwise noted. (Note 6)

SYMBOL	PARAMETER	CONDITIONS	MIN	TYP	MAX	UNITS
G	Gain	Pins 5 and 8 = Open Pins 5 and 8 = $V_{\text{REF}}$		1 10		
$\Delta G$	Gain Error	$V_{\text{OUT}} = \pm 10\text{V}$ LT1990, $G = 1$ LT1990A, $G = 1$ $G = 10$		0.4	0.6	%
				0.07	0.28	%
				0.2	0.8	%
GNL	Gain Nonlinearity	$V_{\text{OUT}} = \pm 10\text{V}$ $G = 1$ $G = 10$		0.0008	0.002	%
				0.005	0.02	%
$V_{\text{CM}}$	Input Voltage Range	Guaranteed by CMRR	-250		250	V
CMRR	Common Mode Rejection Ratio, RTI	$V_{\text{CM}} = -250\text{V}$ to $250\text{V}$ LT1990 LT1990A	60	68		dB
			70	75		dB
$V_{\text{OS}}$	Offset Voltage, RTI	$G = 1, 10$		0.9	5.2	mV
$e_n$	Input Noise Voltage, RTI	$f_0 = 0.1\text{Hz}$ to $10\text{Hz}$		22		$\mu\text{V}_{\text{P-P}}$
	Noise Voltage Density, RTI	$f_0 = 1\text{kHz}$		1		$\mu\text{V}/\sqrt{\text{Hz}}$
$R_{\text{IN}}$	Input Resistance	Differential Common Mode		2		$\text{M}\Omega$
				0.5		$\text{M}\Omega$
PSRR	Power Supply Rejection Ratio, RTI	$V_S = \pm 1.35\text{V}$ to $\pm 18\text{V}$	82	100		dB
	Minimum Supply Voltage	Guaranteed by PSRR		$\pm 1.2$	$\pm 1.35$	V
$I_S$	Supply Current			140	180	$\mu\text{A}$
$V_{\text{OUT}}$	Output Voltage Swing		$\pm 14.5$	$\pm 14.79$		V

## ±15V ELECTRICAL CHARACTERISTICS

$V_S = \pm 15V$ ,  $R_L = 10k$ ,  $V_{CM} = V_{REF} = 0V$ ,  $G = 1, 10$ ,  $T_A = 25^\circ C$ , unless otherwise noted. (Note 6)

SYMBOL	PARAMETER	CONDITIONS	MIN	TYP	MAX	UNITS
$I_{SC}$	Output Short-Circuit Current	Short to $V^-$	6	9		mA
		Short to $V^+$	15	22		mA
BW	Bandwidth	$G = 1$		105		kHz
		$G = 10$		7		kHz
SR	Slew Rate	$G = 1$ , $V_{OUT} = \pm 10V$	0.3	0.55		V/ $\mu s$
	Settling Time to 0.01%	10V Step, $G = 1$		60		$\mu s$
$AV_{REF}$	Reference Gain to Output	$G = 1$		$1 \pm 0.0007$		
		$G = 10$		$1 \pm 0.007$		

The ● denotes the specifications which apply over the temperature range of  $0^\circ C \leq T_A \leq 70^\circ C$ .  $V_S = \pm 15V$ ,  $R_L = 10k$ ,  $V_{CM} = V_{REF} = 0V$ ,  $G = 1, 10$ , unless otherwise noted. (Notes 4, 6)

SYMBOL	PARAMETER	CONDITIONS	LT1990C/LT1990I			UNITS
			MIN	TYP	MAX	
$\Delta G$	Gain Error	$V_{OUT} = \pm 10V$			0.65	%
		LT1990, $G = 1$	●		0.33	%
		LT1990A, $G = 1$	●		0.9	%
GNL	Gain Nonlinearity	$V_{OUT} = \pm 10V$				
		$G = 1$	●		0.0025	%
		$G = 10$	●		0.025	%
G/T	Gain vs Temperature	$G = 1$ (Note 10)	●	2	10	ppm/ $^\circ C$
		$G = 10$ (Note 10)	●	7	20	ppm/ $^\circ C$
$V_{CM}$	Input Voltage Range	Guaranteed by CMRR	●	-250	250	V
CMRR	Common Mode Rejection Ratio, RTI	$V_{CM} = -250V$ to 250V				
		LT1990	●	59		dB
		LT1990A	●	68		dB
$V_{OS}$	Input Offset Voltage, RTI	$G = 1, 10$	●		6.2	mV
$V_{OS}/T$	Input Offset Voltage Drift, RTI	(Note 10)	●	5	22	$\mu V/^\circ C$
$V_{OSH}$	Input Offset Voltage Hysteresis, RTI	(Note 11)	●	250		$\mu V$
PSRR	Power Supply Rejection Ratio, RTI	$V_S = \pm 1.35V$ to $\pm 18V$	●	80		dB
	Minimum Supply Voltage	Guaranteed by PSRR	●		$\pm 1.35$	V
$I_S$	Supply Current		●		230	$\mu A$
$V_{OUT}$	Output Voltage Swing		●	$\pm 14.4$		V
$I_{SC}$	Output Short-Circuit Current	Short to $V^-$	●	5		mA
		Short to $V^+$	●	13		mA
SR	Slew Rate	$G = 1$ , $V_{OUT} = \pm 10V$	●	0.25		V/ $\mu s$

## ±15V ELECTRICAL CHARACTERISTICS

The ● denotes the specifications which apply over the temperature range of  $-40^{\circ}\text{C} \leq T_A \leq 85^{\circ}\text{C}$ .  $V_S = \pm 15\text{V}$ ,  $R_L = 10\text{k}$ ,  $V_{\text{CM}} = V_{\text{REF}} = 0\text{V}$ ,  $G = 1, 10$ , unless otherwise noted. (Notes 4, 6)

SYMBOL	PARAMETER	CONDITIONS	LT1990C/LT1990I			UNITS
			MIN	TYP	MAX	
$\Delta G$	Gain Error	$V_{\text{OUT}} = \pm 10\text{V}$	●			
		LT1990, $G = 1$	●		0.67	%
		LT1990A, $G = 1$	●		0.35	%
GNL	Gain Nonlinearity	$V_{\text{OUT}} = \pm 10\text{V}$	●			
		$G = 1$	●		0.003	%
		$G = 10$	●		0.03	%
G/T	Gain vs Temperature	$G = 1$ (Note 10)	●	2	10	ppm/ $^{\circ}\text{C}$
		$G = 10$ (Note 10)	●	7	20	ppm/ $^{\circ}\text{C}$
$V_{\text{CM}}$	Input Voltage Range	Guaranteed by CMRR	●	-250	250	V
CMRR	Common Mode Rejection Ratio, RTI	$V_{\text{CM}} = -250\text{V}$ to $250\text{V}$	●	58		dB
		LT1990 LT1990A	●	67		dB
$V_{\text{OS}}$	Input Offset Voltage, RTI	$G = 1, 10$	●		6.7	mV
$V_{\text{OS}}/T$	Input Offset Voltage Drift, RTI	(Note 10)	●	5	22	$\mu\text{V}/^{\circ}\text{C}$
$V_{\text{OSH}}$	Input Offset Voltage Hysteresis, RTI	(Note 11)	●	250		$\mu\text{V}$
PSRR	Power Supply Rejection Ratio, RTI	$V_S = \pm 1.35\text{V}$ to $\pm 18\text{V}$	●	78		dB
		Minimum Supply Voltage	●		$\pm 1.35$	V
$I_S$	Supply Current		●		280	$\mu\text{A}$
$V_{\text{OUT}}$	Output Voltage Swing		●	$\pm 14.3$		V
$I_{\text{SC}}$	Output Short-Circuit Current	Short to $V^-$	●	3		mA
		Short to $V^+$	●	10		mA
SR	Slew Rate	$G = 1, V_{\text{OUT}} = \pm 10\text{V}$	●	0.2		V/ $\mu\text{s}$

## ±15V ELECTRICAL CHARACTERISTICS

The ● denotes the specifications which apply over the temperature range of  $-40^{\circ}\text{C} \leq T_A \leq 125^{\circ}\text{C}$ .  $V_S = \pm 15\text{V}$ ,  $R_L = 10\text{k}$ ,  $V_{\text{CM}} = V_{\text{REF}} = 0\text{V}$ ,  $G = 1, 10$ , unless otherwise noted. (Notes 4, 6)

SYMBOL	PARAMETER	CONDITIONS	LT1990H			UNITS
			MIN	TYP	MAX	
$\Delta G$	Gain Error	$V_{\text{OUT}} = \pm 10\text{V}$	●			
		LT1990, $G = 1$	●		0.69	%
		LT1990A, $G = 1$	●		0.37	%
GNL	Gain Nonlinearity	$V_{\text{OUT}} = \pm 10\text{V}$	●			
		$G = 1$	●		0.0035	%
		$G = 10$	●		0.035	%
G/T	Gain vs Temperature	$G = 1$ (Note 10)	●	2	10	ppm/ $^{\circ}\text{C}$
		$G = 10$ (Note 10)	●	7	20	ppm/ $^{\circ}\text{C}$
$V_{\text{CM}}$	Input Voltage Range	Guaranteed by CMRR	●	-250	250	V
CMRR	Common Mode Rejection Ratio, RTI	$V_{\text{CM}} = -250\text{V}$ to $250\text{V}$	●	57		dB
		LT1990 LT1990A	●	66		dB
$V_{\text{OS}}$	Input Offset Voltage, RTI	$G = 1, 10$	●		7.4	mV
$V_{\text{OS}}/T$	Input Offset Voltage Drift, RTI	(Note 10)	●	5	22	$\mu\text{V}/^{\circ}\text{C}$

## ±15V ELECTRICAL CHARACTERISTICS

The ● denotes the specifications which apply over the temperature range of  $-40^{\circ}\text{C} \leq T_A \leq 125^{\circ}\text{C}$ .  $V_S = \pm 15\text{V}$ ,  $R_L = 10\text{k}$ ,  $V_{CM} = V_{REF} = 0\text{V}$ ,  $G = 1, 10$ , unless otherwise noted. (Notes 4, 6)

SYMBOL	PARAMETER	CONDITIONS		LT1990H			UNITS
				MIN	TYP	MAX	
$V_{OSH}$	Input Offset Voltage Hysteresis, RTI	(Note 11)	●		250		$\mu\text{V}$
PSRR	Power Supply Rejection Ratio, RTI	$V_S = \pm 1.35\text{V}$ to $\pm 18\text{V}$	●	77			dB
	Minimum Supply Voltage	Guaranteed by PSRR	●			$\pm 1.35$	V
$I_S$	Supply Current		●			330	$\mu\text{A}$
$V_{OUT}$	Output Voltage Swing		●	$\pm 14.2$			V
$I_{SC}$	Output Short-Circuit Current	Short to $V^-$	●	1.5			mA
		Short to $V^+$	●	7			mA
SR	Slew Rate	$G = 1, V_{OUT} = \pm 10\text{V}$	●	0.1			$\text{V}/\mu\text{s}$

**Note 1:** Stresses beyond those listed under Absolute Maximum Ratings may cause permanent damage to the device. Exposure to any Absolute Maximum Rating condition for extended periods may affect device reliability and lifetime.

**Note 2:** ESD (Electrostatic Discharge) sensitive device. Extensive use of ESD protection devices are used internal to the LT1990, however, high electrostatic discharge can damage or degrade the device. Use proper ESD handling precautions.

**Note 3:** A heat sink may be required to keep the junction temperature below absolute maximum.

**Note 4:** The LT1990C/LT1990I are guaranteed functional over the operating temperature range of  $-40^{\circ}\text{C}$  to  $85^{\circ}\text{C}$ . The LT1990H is guaranteed functional over the operating temperature range of  $-40^{\circ}\text{C}$  to  $125^{\circ}\text{C}$ .

**Note 5:** The LT1990C is guaranteed to meet the specified performance from  $0^{\circ}\text{C}$  to  $70^{\circ}\text{C}$  and is designed, characterized and expected to meet specified performance from  $-40^{\circ}\text{C}$  to  $85^{\circ}\text{C}$  but is not tested or QA

sampled at these temperatures. The LT1990I is guaranteed to meet specified performance from  $-40^{\circ}\text{C}$  to  $85^{\circ}\text{C}$ . The LT1990H is guaranteed to meet specified performance from  $-40^{\circ}\text{C}$  to  $125^{\circ}\text{C}$ .

**Note 6:**  $G = 10$  limits are guaranteed by correlation to  $G = 1$  tests and gain error tests at  $G = 10$ .

**Note 7:** Limits are guaranteed by correlation to  $-5\text{V}$  to  $80\text{V}$  CMRR tests.

**Note 8:**  $V_S = 3\text{V}$  limits are guaranteed by correlation to  $V_S = 5\text{V}$  and  $V_S = \pm 15\text{V}$  tests.

**Note 9:**  $V_S = 5\text{V}$  limits are guaranteed by correlation to  $V_S = 3\text{V}$  and  $V_S = \pm 15\text{V}$  tests.

**Note 10:** This parameter is not 100% tested.

**Note 11:** Hysteresis in offset voltage is created by package stress that differs depending on whether the IC was previously at a higher or lower temperature. Offset voltage hysteresis is always measured at  $25^{\circ}\text{C}$ , but the IC is cycled to  $85^{\circ}\text{C}$  I-grade ( $70^{\circ}\text{C}$  C-grade or  $125^{\circ}\text{C}$  H-grade) or  $-40^{\circ}\text{C}$  I/H-grade ( $0^{\circ}\text{C}$  C-grade) before successive measurement.

# TYPICAL PERFORMANCE CHARACTERISTICS

**Supply Current vs Supply Voltage**

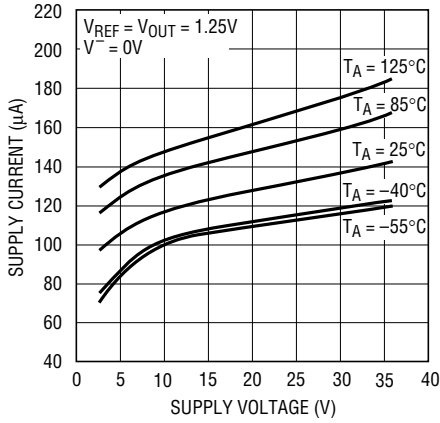

1990 G01

**Supply Current vs Temperature**

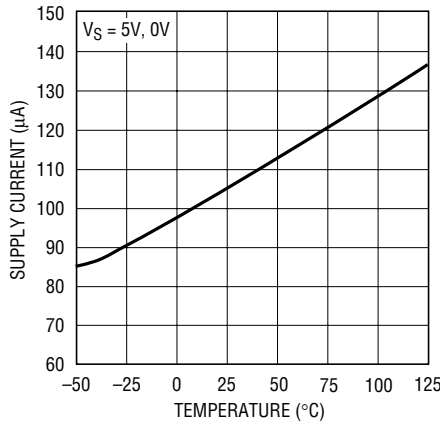

1990 G02

**Output Voltage Swing vs Load Current**

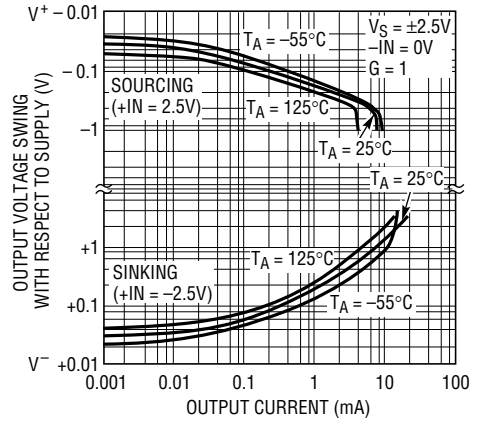

1990 G03

**Output Voltage vs Input Voltage, G = 1**

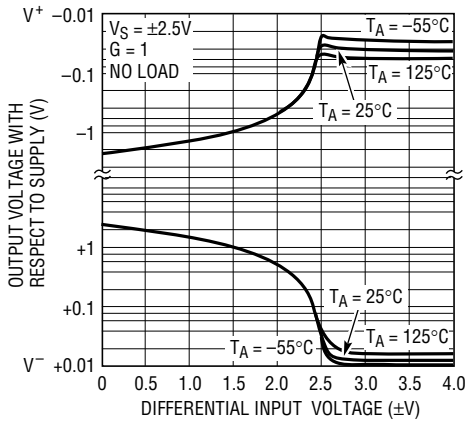

1990 G04

**Output Voltage vs Input Voltage, G = 10**

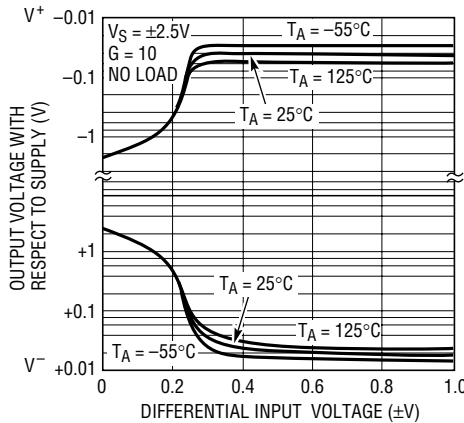

1990 G05

**Output Voltage Swing vs Supply Voltage**

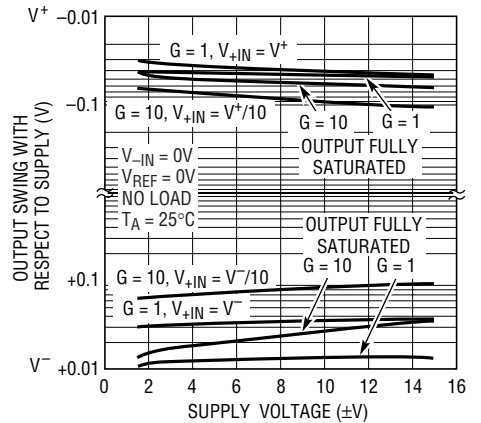

1990 G06

**Output Short-Circuit Current vs Supply Voltage**

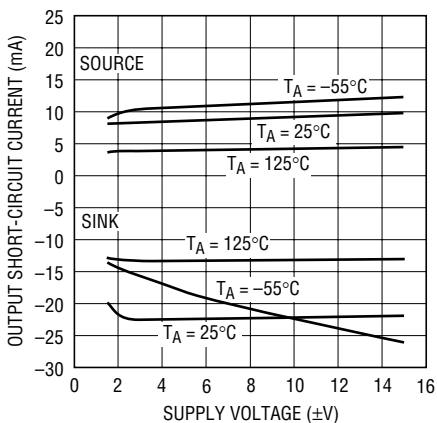

1990 G07

**Input Voltage Range vs Single Supply Voltage**

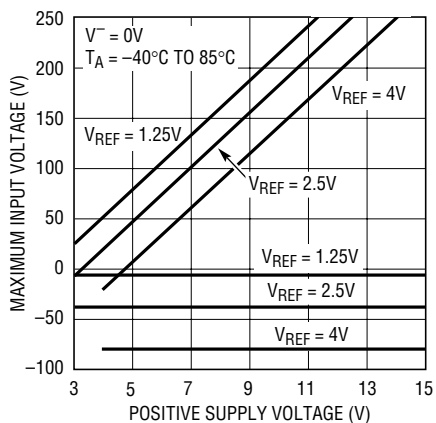

1990 G08

**Input Voltage Range vs Split Supply Voltage**

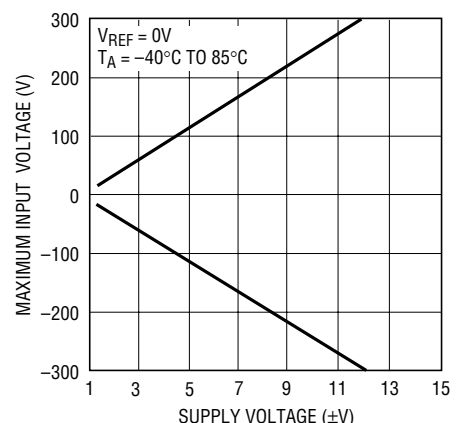

1990 G09

# TYPICAL PERFORMANCE CHARACTERISTICS

**Common Mode Rejection Ratio vs Frequency**

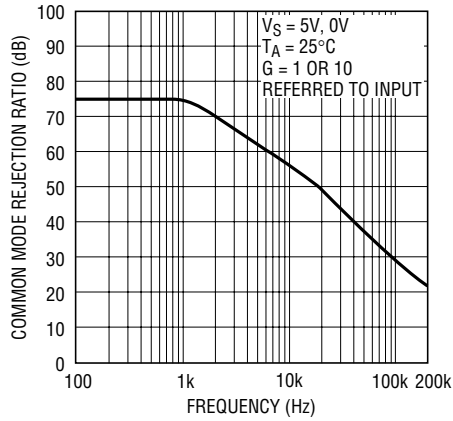

1990 G10

**Gain vs Frequency**

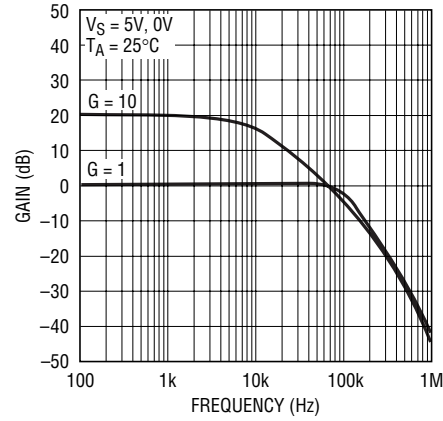

1990 G12

**-3dB Bandwidth vs Supply Voltage,  $G = 1$**

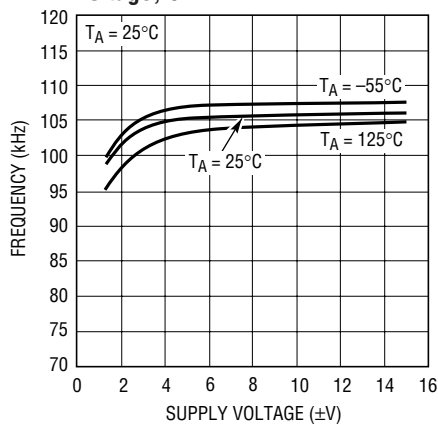

1990 G13

**-3dB Bandwidth vs Supply Voltage,  $G = 10$**

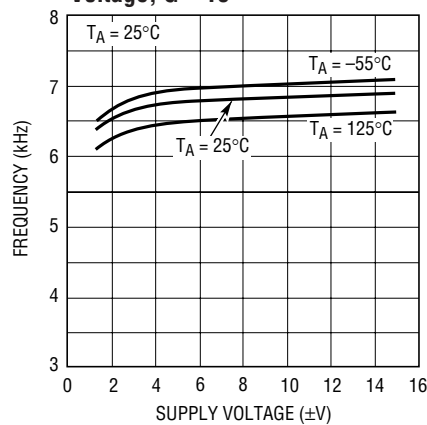

1990 G14

**Slew Rate vs Supply Voltage,  $G = 1$**

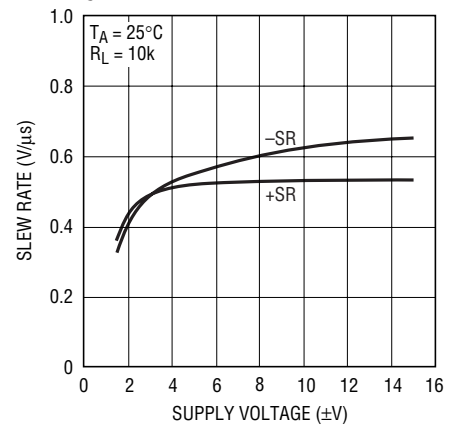

1990 G15

**Slew Rate vs Supply Voltage,  $G = 10$**

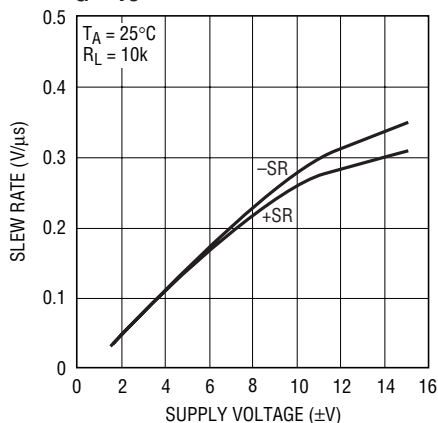

1990 G16

**Slew Rate vs Temperature,  $G = 1$**

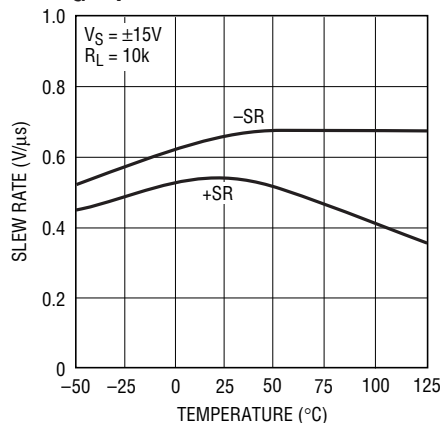

1990 G17

**Slew Rate vs Temperature,  $G = 10$**

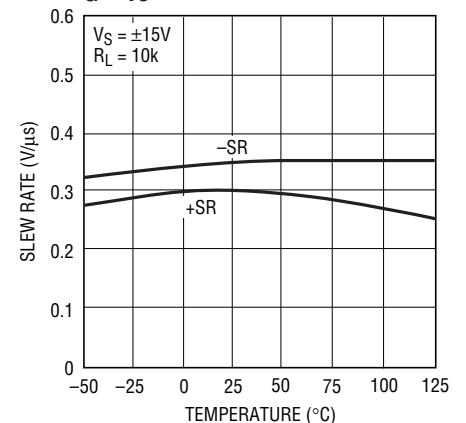

1990 G18

**TYPICAL PERFORMANCE CHARACTERISTICS**

**Output Impedance vs Frequency**

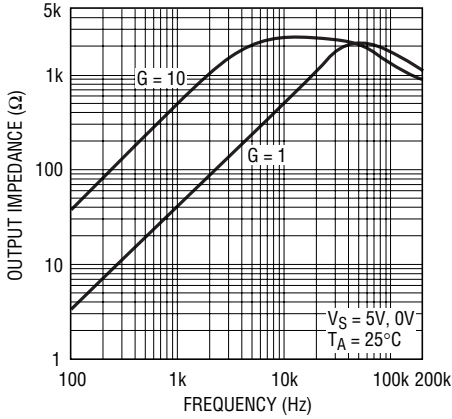

1990 G19

**Power Supply Rejection Ratio vs Frequency**

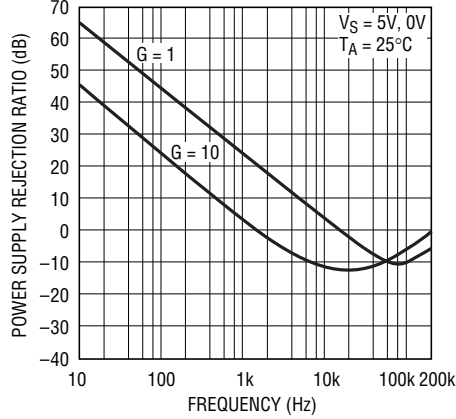

1990 G20

**Warm-Up Drift vs Time**

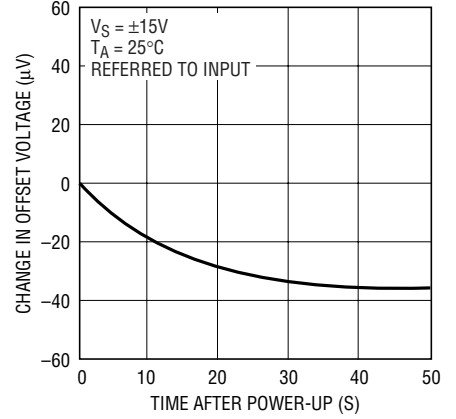

1990 G21

**Settling Time vs Output Step, G = 1**

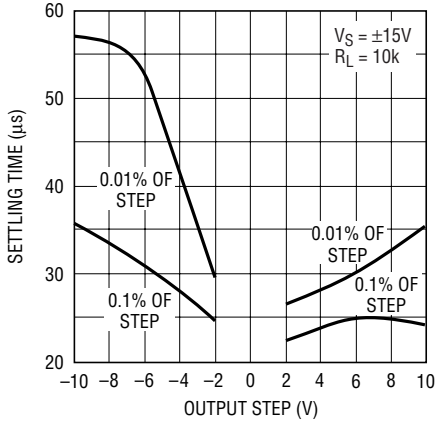

1990 G22

**Settling Time vs Output Step, G = 10**

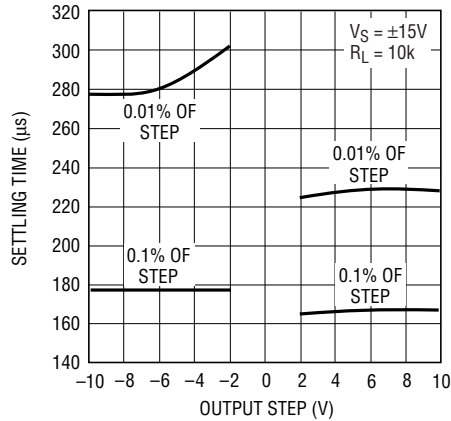

1990 G23

**Voltage Noise Density vs Frequency**

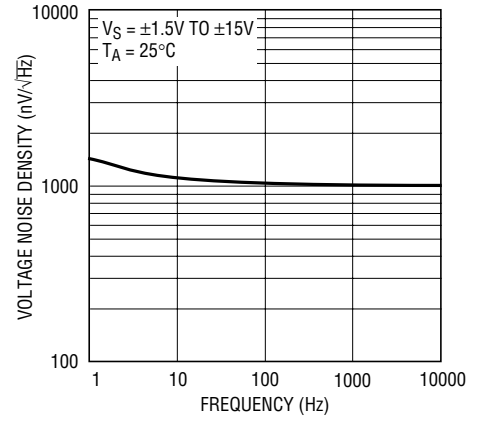

1990 G24

**0.1 to 10Hz Noise Voltage**

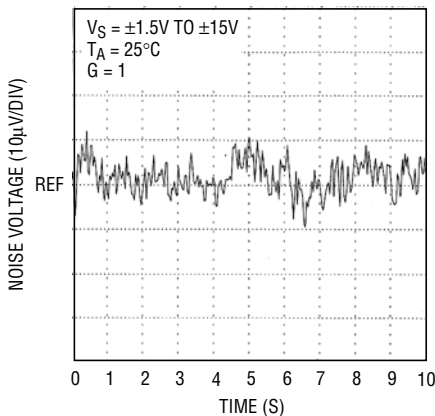

1990 G25

**0.01 to 1Hz Noise Voltage**

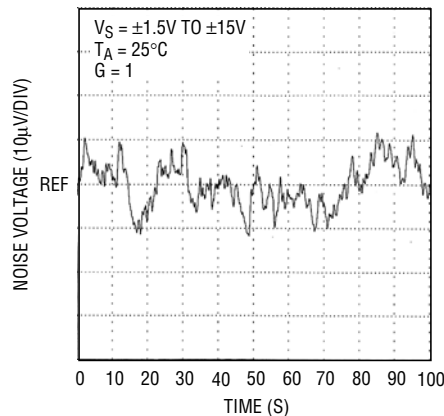

1990 G26

**Overshoot vs Capacitive Load**

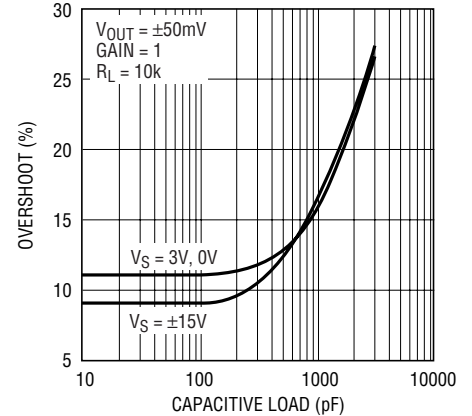

1990 G27

## TYPICAL PERFORMANCE CHARACTERISTICS

Small Signal Transient Response

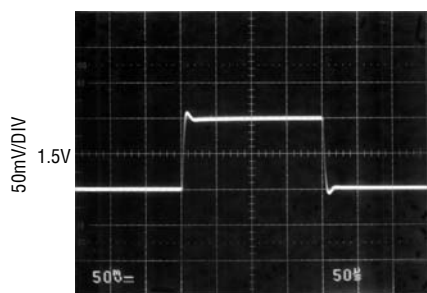

$V_S = 3V, 0V$   
 $G = 1, -1$   
 $R_L = 10k$   
 $V_{REF} = 1.5V$

1990 G28

Small Signal Transient Response

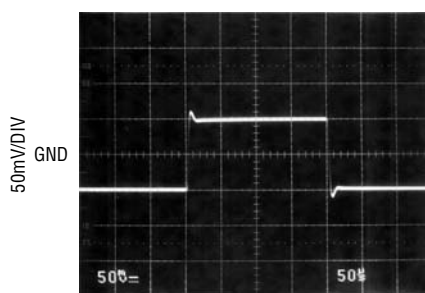

$V_S = \pm 15V$   
 $G = 1, -1$   
 $R_L = 10k$   
 $V_{REF} = GND$

1990 G29

Large Signal Transient Response

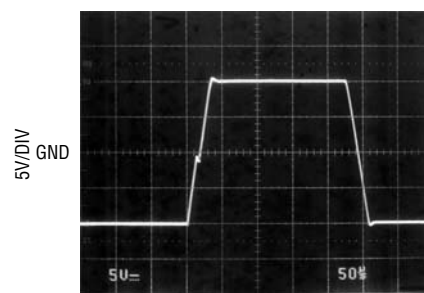

$V_S = \pm 15V$   
 $G = 1, -1$   
 $R_L = 10k$   
 $V_{REF} = GND$

1990 G30

## BLOCK DIAGRAM

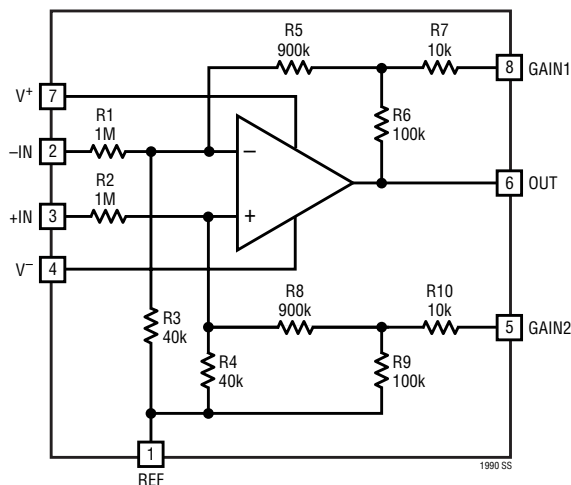

1990 SS

## PIN FUNCTIONS

**REF (Pin 1):** Reference Input. Sets the output level when the difference between the inputs is zero.

**-IN (Pin 2):** Inverting Input. Connects a 1MΩ resistor to the op amp's inverting input. Designed to permit high voltage operation.

**+IN (Pin 3):** Noninverting Input. Connects a 1MΩ resistor to the op amp's noninverting input. Designed to permit high voltage operation.

**V<sup>-</sup> (Pin 4):** Negative Power Supply. Can be either ground (in single supply applications) or a negative voltage (in split supply applications).

**GAIN2 (Pin 5):** Gain = 10 Select Input. Configures the

amplifier for a gain of 10 when connected to the GAIN1 pin and the REF pin. The gain is equal to one when both GAIN2 and GAIN1 are open. See Applications section for additional functions.

**OUT (Pin 6):** Output.  $V_{OUT} = G \cdot (V_{+IN} - V_{-IN}) + V_{REF}$ , in the basic configuration.

**V<sup>+</sup> (Pin 7):** Positive Power Supply. Can range from 2.7V to 36V above the V<sup>-</sup> voltage.

**GAIN1 (Pin 8):** Gain = 10 Select Input. Configures the amplifier for a gain of 10 when connected to the GAIN2 pin and the REF pin. The gain is equal to one when both GAIN1 and GAIN2 are open. See Applications section for additional functions.

1990fb

## APPLICATIONS INFORMATION

### Primary Features

The LT1990 is a complete gain-block solution for high input common mode voltage applications, incorporating a low power precision operational amplifier providing rail-to-rail output swing along with on-chip precision thin-film resistors for high accuracy. The Block Diagram shows the internal architecture of the part. The on-chip resistors form a modified difference amplifier including a reference port for introducing offset or other additive waveforms. With pin-strapping alone either unity gain or gain of 10 is produced with high precision. The resistor network is designed to produce internal common-mode voltage division of 27 so that a very large input range is available compared to the power supply voltage(s) used by the LT1990 itself. The LT1990 is ideally suited to situations where relatively small signals need to be extracted from high voltage circuits, as is the case in many current monitoring instrumentation applications for example. With the ability to accept a range of input voltages well outside the limits of the local power rails and its greater than 1MΩ input impedances, development of precision low power over-the-top and under-the-bottom instrumentation designs is greatly simplified with the LT1990 single chip solution over conventional discrete implementations.

### Classic Difference Amplifier

Used in the basic difference amplifier topology where the gain G is pin-strap configurable to be unity or ten, the following relationship is realized:

$$V_O = G \cdot (V_{+IN} - V_{-IN}) + V_{REF}$$

To operate in unity gain, the GAIN1 and GAIN2 pins are left disconnected. For G = 10 operation, the GAIN1 and GAIN2 pins are simply connected to the REF pin.

The input common mode range capability is up to ±250V, governed by the following relationships:

For G = 1 and G = 10 where GAIN1 and GAIN2 are only tied together (not grounded, etc):

$$V_{CM+} \leq 27 \cdot V^+ - 26 \cdot V_{REF} - 23$$

$$V_{CM-} \geq 27 \cdot V^- - 26 \cdot V_{REF} + 27$$

For G = 10 where GAIN1 and GAIN2 are tied to a common potential  $V_{GAIN}$ :

$$V_{CM+} \leq 27 \cdot V^+ - 26 \cdot V_{REF} - 23 - V_{GAIN}$$

$$V_{CM-} \geq 27 \cdot V^- - 26 \cdot V_{REF} + 27 - V_{GAIN}$$

For split supplies over about ±11V, the full ±250V common mode range is normally available (with  $V_{REF}$  a small fraction of the supply). With lower supply voltages, an appropriate selection of  $V_{REF}$  can tailor the input common mode range to a specific requirement. As an example, the following low supply voltage scenarios are readily implemented with the LT1990:

Supply	$V_{REF}$	$V_{CM}$ Range
+3V	1.25V	-5V to 25V (e.g. 12V automotive environment)
+5V	1.25V	-5V to 80V (e.g. 42V automotive environment)
+5V	4.00V	-77V to 8V (e.g. telecom environment; use downward signaling)

### Configuring Other Gains

An intermediate gain G ranging between 1 and 10 may be produced by placing an adjustable resistance between the GAIN1 and GAIN2 pins according to the following nominal relationship:

$$R_{GAIN} \approx (180k / (G - 1)) - 20k$$

While the expression is exact, the value is approximate because the absolute resistance of the internal network could vary on a unit-to-unit basis by as much as ±30% from the nominal figures and the external gain resistance is required to accommodate that deviation. Once adjusted, however, the gain stability is excellent by virtue of the -30ppm/°C typical temperature coefficient offered by the on-chip thin-film resistor process.

### Preserving and Enhancing Common Mode Rejection

The basic difference amplifier topology of the LT1990 requires that source impedances seen by the input pins +IN and -IN, should be matched to within a few tens of ohms to avoid increasing common mode induced errors beyond the basic production limits of the part. Known source imbalances beyond that level should be compensated for by the addition of series resistance to the lower-impedance source. Also the source impedance of a signal connected to the REF pin must be on the order of a few ohms or less to preserve the high accuracy of the LT1990.



**TYPICAL APPLICATION**

**Telecom Supply Current Monitor**

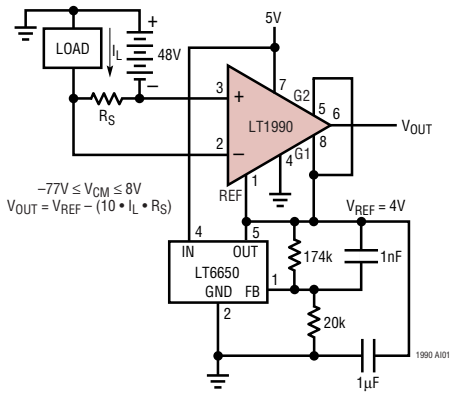

**Selectable Gain Amplifier**

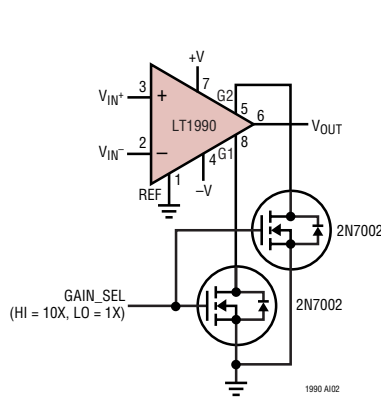

**Boosted Bidirectional Controlled Current Source**

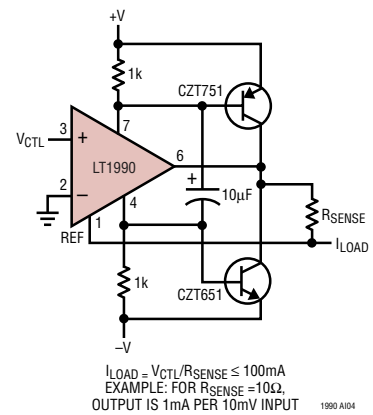

**Bidirectional Controlled Current Source**

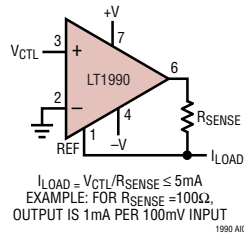

**PACKAGE DESCRIPTION**

**S8 Package**  
**8-Lead Plastic Small Outline (Narrow .150 Inch)**  
 (Reference LTC DWG # 05-08-1610)

RECOMMENDED SOLDER PAD LAYOUT

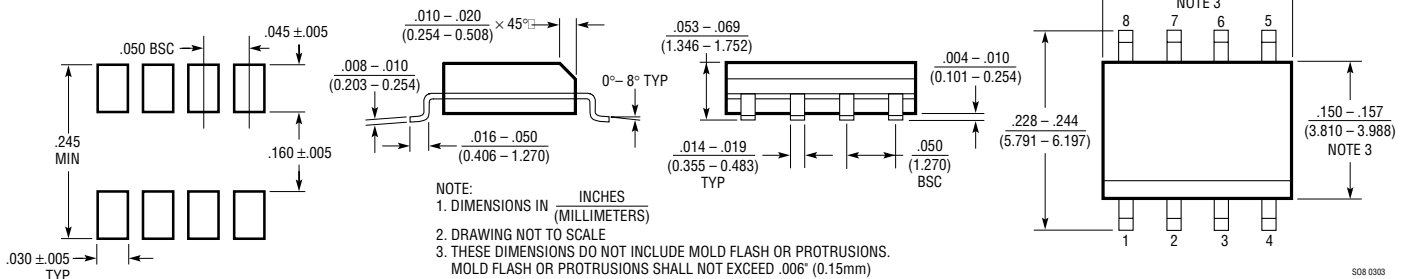

**RELATED PARTS**

PART NUMBER	DESCRIPTION	COMMENTS
LT1787	Precision High Side Current Sense Amplifier	On-Chip Precision Resistor Array
LT1789	Micropower Instrumentation Amplifier	Micropower, Precision, G = 1 to 1000
LTC1921	Dual -48V Supply and Fuse Monitor	Withstands ±200V Transients
LT1991	High Accuracy Difference Amplifier	Micropower, Precision, Pin Selectable G = -13 to 14
LT1995	30MHz, 1000V/μs Gain Selectable Amplifier	Pin Selectable G = -7 to 8
LT6910	Single Supply Programmable Gain Amplifier	Digitally Controlled, SOT-23, G = 0 to 100

## Looking for pricing, stock, or lifecycle information?

Click below to explore more details on WIN SOURCE:

- ⊖ [View LT1990AHS8#TRPBF on WIN SOURCE](#)
- ⊖ [Analog Devices Inc. Information](#)

## Optimize Your Supply Chain with WIN SOURCE Solutions

- ✓ Global Sourcing Solution
- ✓ Obsolete Management
- ✓ Cost Control Management
- ✓ Shortage Management
- ✓ Alternative Solution
- ✓ Excess Inventory Management