



**THE DATASHEET OF
GG040205170N2P**



GiGuard® - ESD Protection for High Speed Circuits



Bi-Directional Leadless Transient Voltage Suppressor Diodes For General Purpose Use

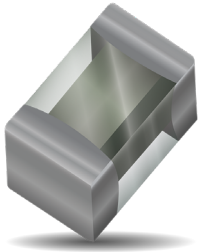

GENERAL DESCRIPTION

Intended for general purpose applications and utilizing the latest in TVS Technology, combined with a unique leadless package, the new GiGuard series of ESD Suppression Diodes offers Clamping Voltages below 12v and cap values as low as 0.3pF. This combination of excellence both protects sensitive ICs during ESD events and preserves the integrity of the protected high speed signals. The KYOCERA AVX GG® series fits perfectly onto the same PCB solder pads as standard EIA 0201/0402/0603 components.

The GG® series complies with IEC 61000-4-2(ESD), Level 4+ ($\pm 20\text{kV}$ air, $\pm 20\text{kV}$ contact discharge), IEC 61000-4-4 (electrical fast transient -EFT) (20A, 5/50 ns), very fast charged device model (CDM) ESD and cable discharge event (CDE).

APPLICATIONS

- USB 2.0/3.0
- Tablets/Cell Phones Touch Screens
- Network Communications
- Gigabyte Ethernet
- High Def Multimedia Interface (HDMI)
- Mobile Phone Touchscreen

FEATURES

- Low Capacitance (.3pF to 17pF typ)
- Low Vc (<12v @ 1a)
- Bi-Directional protection
- Leadless 0201/0402 case size
- -55°C ~ 125°C Operating Range

CIRCUIT DIAGRAM

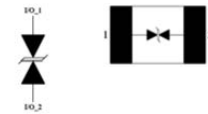

HOW TO ORDER

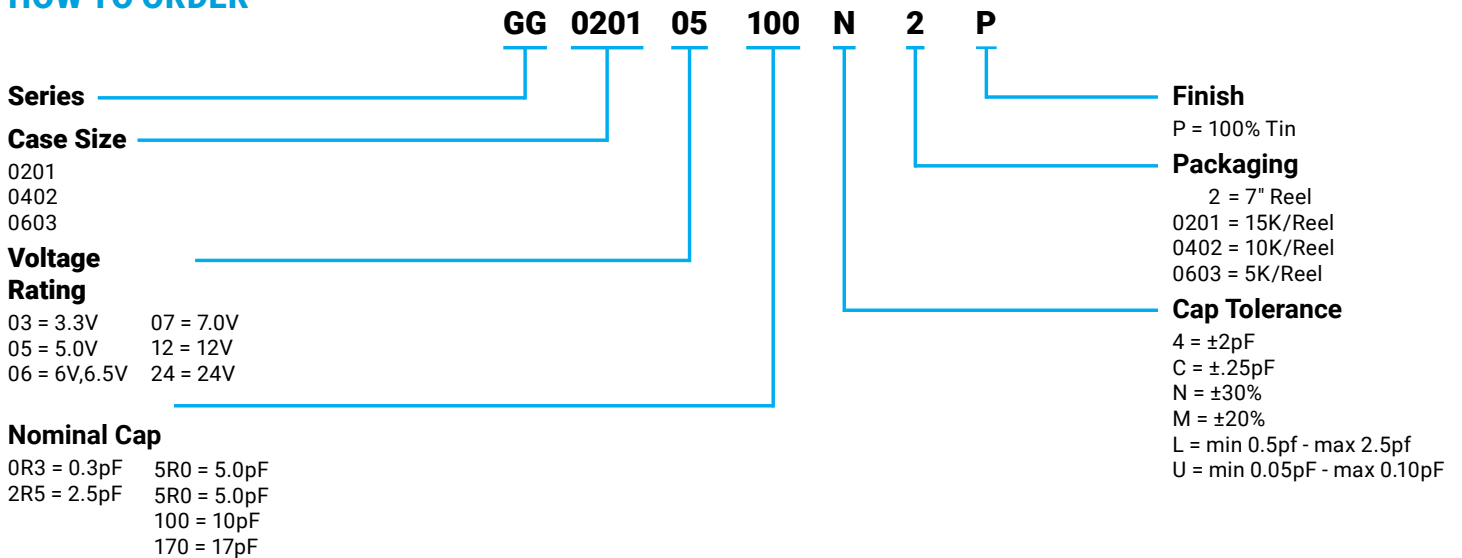

CHARACTERISTIC TEST DESCRIPTION

Characteristic Test Description	Symbol	Units
Nominal Reverse Working Voltage	V_{wrm}	V
Reverse Typ. Breakdown Voltage @ 1ma	V_{br}	V
Reverse Leakage Current @Vwrm	IL	ua
Peak Pulse Power (tp=8x20us)	P_{pp}	W
Peak Pulse Current (tp=8x20us)	I_{pp}	A
ESD Rating - Air (150pf, 330Ω network)	V_{air}	KV
ESD Rating - Contact (150pf, 330Ω network)	V_{con}	KV

Characteristic Test Description	Symbol	Units
Max Clamp Voltage @ Ipp = 16a	V_{c16a}	V
Max ESD Clamp Voltage @ 8KV	V_{c8k}	V
Max Clamp Voltage @ Ipp = 1a	V_c	V
Max Clamp Voltage @ Ipp	V_{clpp}	V
Nominal Capacitance (Vr=0v, f=1Mhz)	C_{nom}	pF
Allowable Capacitance Range	$C_{ap(pF)}$	min-max

GiGuard® - ESD Protection for High Speed Circuits



Bi-Directional Leadless Transient Voltage Suppressor Diodes
For General Purpose Use

GENERAL ELECTRICAL CHARACTERISTICS

KYOCERA AVX Part Number	V _{rwv} (V)	C _{nom} (pF)	Cap Min (pf)	Cap Max (pF)	V _{br} Typ (V)	IL (μa)	V _c (@ I _{pp} =1a, tp=8x20μs) (V)	I _{pp} (A)	V _c (@I _{pp} , tp=8x20μs) (V)	P _{pp} (W)	V _{air} (KV)	V _{con} (KV)	V _c (@8KV) (V)	Pack QTY
GG020103100N2P	3.3	10.0	7	13	4.0	<0.1	≤6	7	≤10	70.0	±20	±20	≤12	15000
GG020105100N2P	5.0	10.0	7	13.0	5.5	<0.1	≤8	6	≤12	60.0	±20	±20	≤12	15000
GG0201052R542P	5.0	2.5	0.5	4.5	6.7	<0.1	≤12	3	≤15	46.0	±20	±15	≤16	15000
GG040203100N2P	3.3	10.0	7	13	4.0	<0.1	≤6	8	≤10	80.0	±30	±30	≤10	10000
GG0402052R542P	5.0	2.5	0.5	4.5	5.5	<0.1	≤12	3	≤15.5	46.0	±15	±15	≤16	10000
GG0402055R042P	5.0	5.0	3	7.0	5.2	<0.1	≤12	4	≤16	60.0	±15	±15	≤15	10000
GG040205100N2P	5.0	10.0	7	13.0	5.5	<0.1	≤8	8	≤12	96.0	±25	±25	≤12	10000
GG040205170N2P	5.0	17.0	11.9	22.0	5.1	<0.1	≤6.5	8	≤10	80.0	±30	±30	≤12	10000
GG040205320M2P	5.0	32.0	25.6	38.4	6	<0.1	≤7	18	≤11	200.0	±30	±30	≤11	10000
GG040207100N2P	7.0	10.0	7	13	9.0	<0.1	≤10	6	≤12	72.0	±30	±30	≤13	10000
GG0402126R042P	12.0	6.0	4	8	18.0	<0.1	≤18	6	≤22	130.0	±25	±25	≤22	10000
GG060303100N2P	3.3	10.0	7	13	3.4	<0.1	≤6	8	≤10	80.0	±30	±30	≤10	5000
GG0603052R542P	5.0	2.5	0.5	4.5	6.7	<0.1	≤12	3	≤15	45.0	±15	±15	≤16	5000
GG060305100N2P	5.0	10.0	7	13	7.5	<0.1	≤8	8	≤12	96.0	±25	±25	≤12	5000

HIGH POWER ELECTRICAL CHARACTERISTICS

KYOCERA AVX Part Number	V _{rwv} (V)	C _{nom} (pF)	Cap Min (pf)	Cap Max (pF)	V _{br} Typ (V)	IL (μa)	V _c (@ I _{pp} =1a, tp=8x20μs) (V)	I _{pp} (A)	V _c (@I _{pp} , tp=8x20μs) (V)	P _{pp} (W)	V _{air} (KV)	V _{con} (KV)	V _c (@8KV) (V)	Pack QTY
GG0402050R8L2P	5.0	0.8	0.5	2.5	8.0	<0.1	≤9	7	≤15	100	±30	±30	≤13	10000
GG0402051R5L2P	5.0	1.5	0.5	2.5	8.0	<0.1	≤9	15	≤20	300	±30	±30	≤12	10000

LOW CAP ELECTRICAL CHARACTERISTICS

KYOCERA AVX Part Number	V _{rwv} (V)	C _{nom} (pF)	Cap Min (pf)	Cap Max (pF)	V _{br} Typ (V)	IL (μa)	V _c (@ I _{pp} =1a, tp=8x20μs) (V)	I _{pp} (A)	V _c (@I _{pp} , tp=8x20μs) (V)	P _{pp} (W)	V _{air} (KV)	V _{con} (KV)	V _c (@8KV) (V)	Pack QTY
GG0201050R3C2P	5.0	0.3	0.15	0.55	8.0	<0.1	≤15	3	≤20	60.0	±20	±20	≤30	15000
GG0402050R4C2P	5.0	0.35	0.15	0.65	8.5	<0.1	≤10	4	≤12	60.0	±20	±20	≤15	10000
GG0402050R3C2P	5.0	0.3	0.15	0.55	7.0	<0.1	≤12	3	≤15.5	54.0	±20	±20	≤30	10000
GG0402060R3C2P	6.5	0.3	0.15	0.55	7.0	<0.1	≤12	3	≤15.5	54.0	±20	±20	≤30	10000

GiGuard® - ESD Protection for High Speed Circuits



Bi-Directional Leadless Transient Voltage Suppressor Diodes
For General Purpose Use

GG020105100N2P (10PF)

TLP Measurement

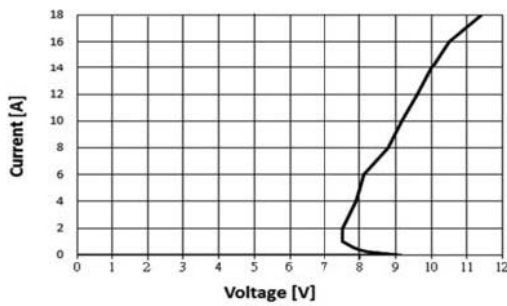

Voltage Sweeping of I/O_1 to I/O_2

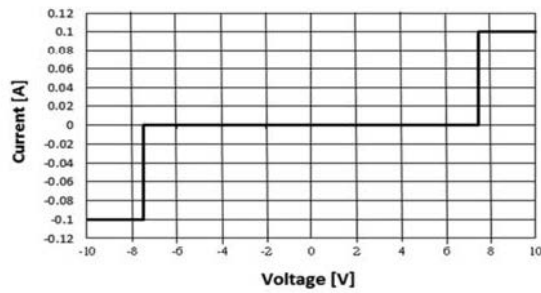

ESD Clamping of I/O_1 to I/O_2
(+8kV Contact per IEC 61000-4-2)

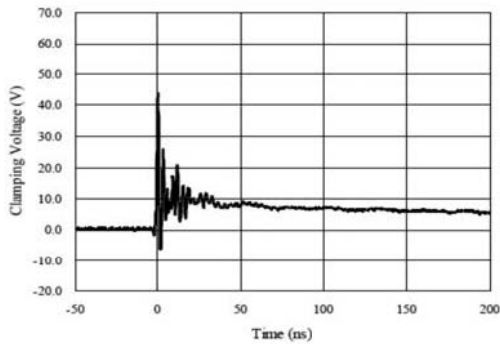

ESD Clamping of I/O_1 to I/O_2
(-8kV Contact per IEC 61000-4-2)

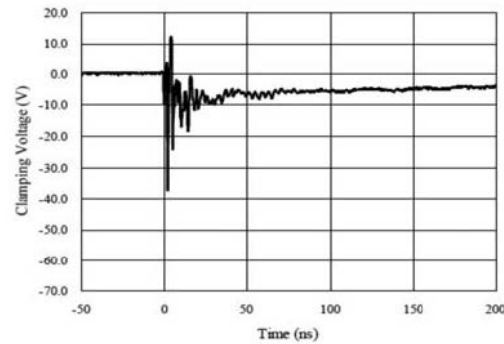

GG0402060R3C2P (0.3PF)

TLP Measurement

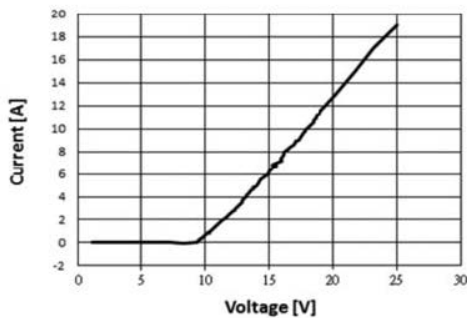

Voltage Sweeping of I/O_1 to I/O_2

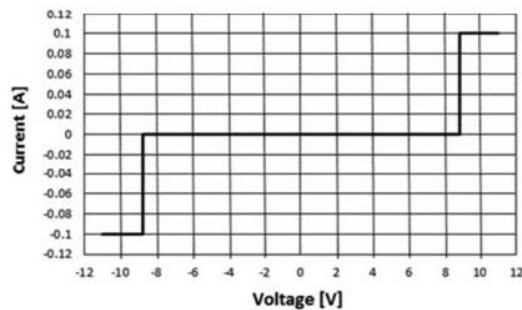

ESD Clamping of I/O_1 to I/O_2
(+8kV Contact per IEC 61000-4-2)

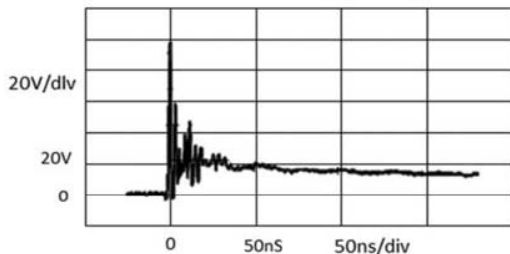

ESD Clamping of I/O_1 to I/O_2
(-8kV Contact per IEC 61000-4-2)

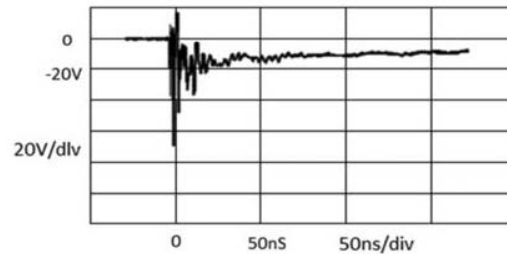

GG0402052R542P (2.5PF)

TLP Measurement

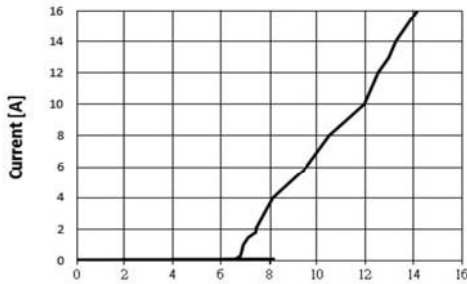

Voltage Sweeping of I/O_1 to I/O_2

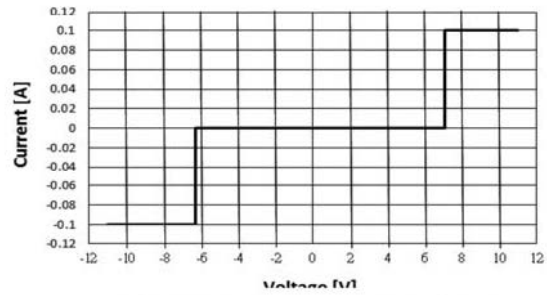

ESD Clamping of I/O_1 to I/O_2
(+8kV Contact per IEC 61000-4-2)

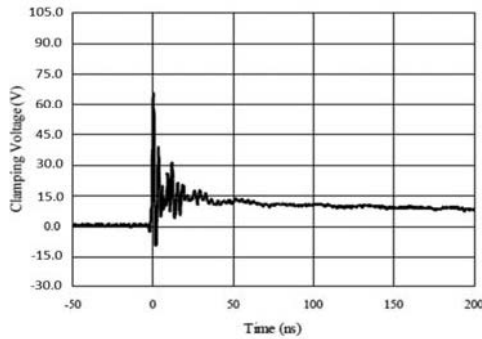

ESD Clamping of I/O_1 to I/O_2
(-8kV Contact per IEC 61000-4-2)

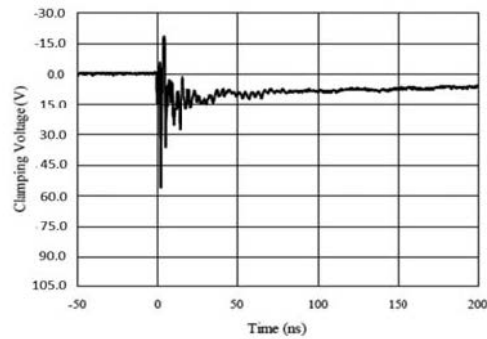

GG0402055R042P (5.0PF)

TLP Measurement of I/O_1 to I/O_2

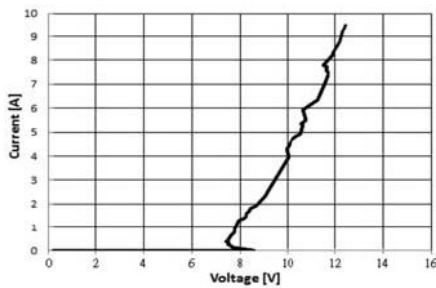

Voltage Sweeping of I/O_1 to I/O_2

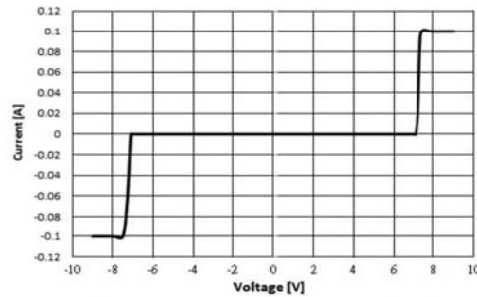

ESD Clamping of I/O_1 to I/O_2
(+8kV Contact per IEC 61000-4-2)

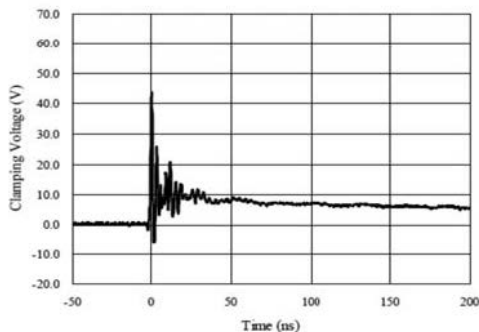

ESD Clamping of I/O_1 to I/O_2
(-8kV Contact per IEC 61000-4-2)

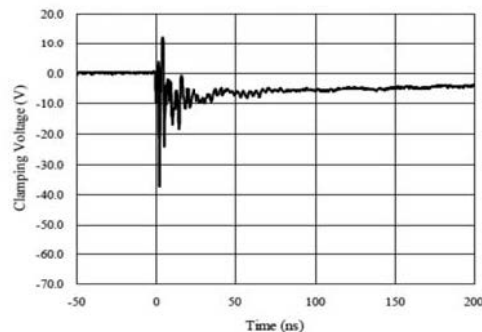

GG040205100N2P (10PF)

TLP Measurement

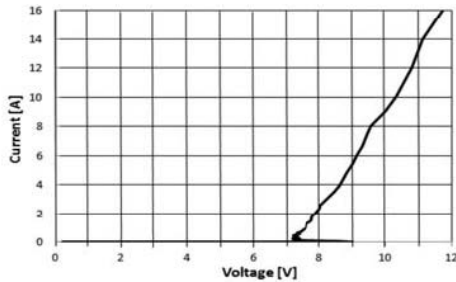

Voltage Sweeping of I/O_1 to I/O_2

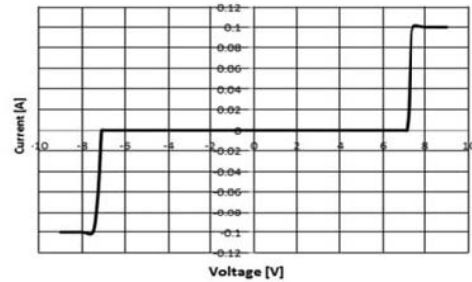

ESD Clamping of I/O_1 to I/O_2
(+8kV Contact per IEC 61000-4-2)

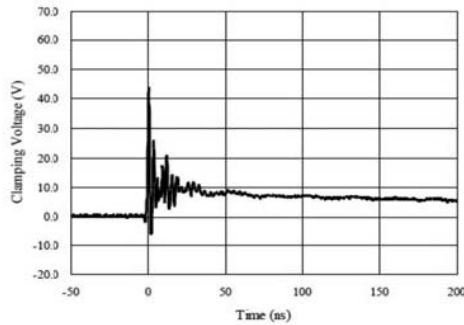

ESD Clamping of I/O_1 to I/O_2
(-8kV Contact per IEC 61000-4-2)

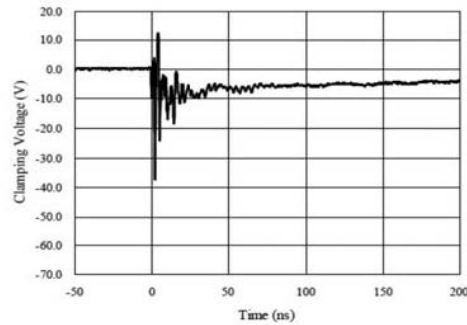

GG040205170N2P (17PF)

TLP Measurement

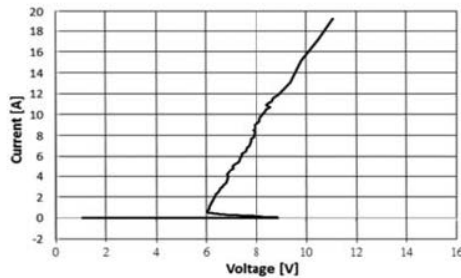

Voltage Sweeping of I/O_1 to

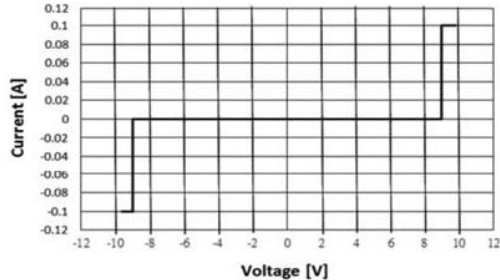

ESD Clamping of I/O_1 to I/O_2
(+8kV Contact per IEC 61000-4-2)

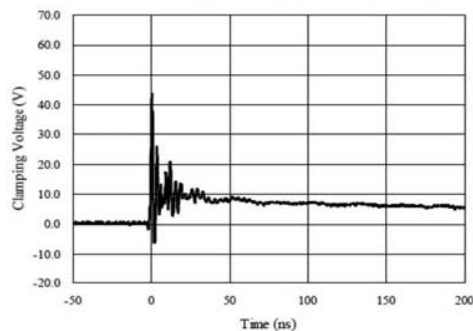

ESD Clamping of I/O_1 to I/O_2
(-8kV Contact per IEC 61000-4-2)

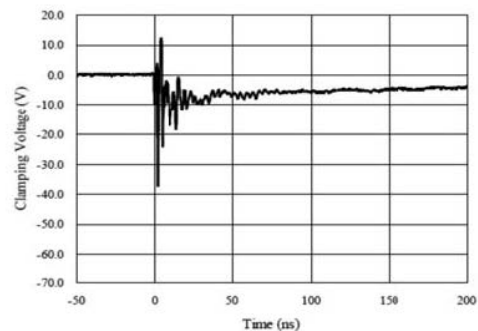

TEMPERATURE DERATING

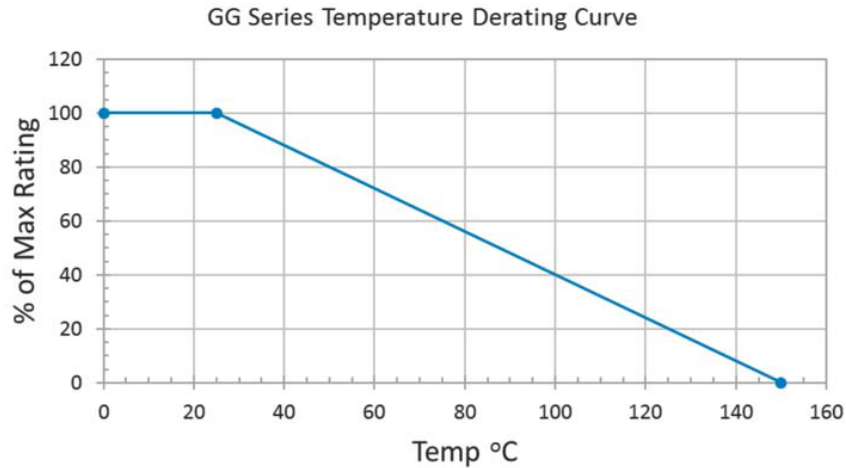

DIMENSIONS

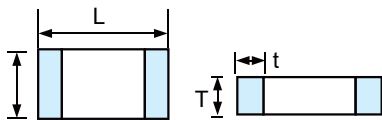

Size	Length (L)	Width (W)	Thickness (T)	Termination (t)
0201	0.60 ± 0.03 (0.024 ± 0.001)	0.30 ± 0.03 (0.012 ± 0.001)	0.30 ± 0.03 (0.012 ± 0.001)	0.15 ± 0.05 (0.006 ± 0.002)
0402	1.00 ± 0.05 (0.039 ± 0.002)	0.60 ± 0.05 (0.024 ± 0.002)	0.50 ± 0.05 (0.020 ± 0.002)	0.20 ± 0.05 (0.008 ± 0.002)
0603	1.60 ± 0.10 (0.063 ± 0.004)	0.80 ± 0.10 (0.031 ± 0.004)	0.60 ± 0.10 (0.024 ± 0.004)	0.30 ± 0.05 (0.012 ± 0.002)

RECOMMENDED REFLOW SOLDER PAD

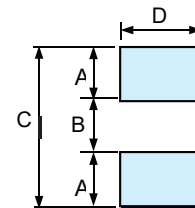

Size	A	B	C	D
0201	0.25 ± 0.05 (0.010 ± 0.002)	0.30 ± 0.05 (0.012 ± 0.002)	0.80 ± 0.15 (0.031 ± 0.006)	0.275 ± 0.025 (0.011 ± 0.001)
0402	0.61 ± 0.05 (0.024 ± 0.002)	0.51 ± 0.05 (0.020 ± 0.002)	1.70 ± 0.05 (0.067 ± 0.002)	0.51 ± 0.05 (0.020 ± 0.002)
0603	0.30 ± 0.05 (0.012 ± 0.002)	1.0 ± 0.1 (0.039 ± 0.004)	1.6 ± 0.1 (0.063 ± 0.004)	0.6 ± 0.1 (0.024 ± 0.004)

RECOMMENDED SOLDER REFLOW PROFILES

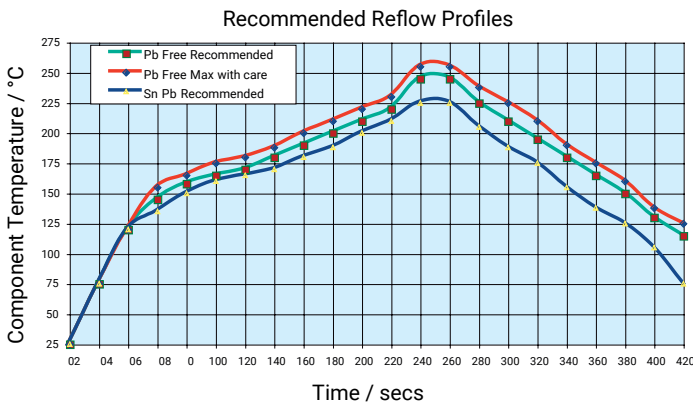

Hand Soldering Cautions

In hand soldering of the Devices. Large temperature gradient between preheated the Devices and the tip of soldering iron may cause electrical failures and mechanical damages such as cracking or breaking of the devices. The soldering shall be carefully controlled and carried out so that the temperature gradient is kept minimum with following recommended conditions for hand soldering.

RECOMMENDED SOLDERING CONDITION 1

- Solder: **0.12~0.18mm** Thread solder (Sn96.5:Ag3.5) with soldering flux in the core Rosin-based and non-activated flux is recommended.
- Preheating: The Devices shall be preheated so that Temperature Gradient between the devices and the tip of soldering iron is 150° or below.
- Soldering Iron: Rated Power of 20w max with 3mm soldering tip in diameter. Temperature of soldering iron tip **300°Cmax, 3-5sec** (The required amount of solder shall be melted in advance on the soldering tip.)
- Cooling: After soldering. The Devices shall be cooled gradually at room ambient temperature.

RECOMMENDED SOLDERING CONDITION 2 – WITHOUT PREHEATING

- Temperature of soldering iron tip 300°C max, 3-5sec.
- Solder iron tip shall not directly touch to Devices.
- Solder iron tip shall be fully preheated before soldering while soldering iron tip to the external electrode of Devices.

Bi-Directional Leadless Transient Voltage Suppressor Diodes For General Purpose Use

PACKAGING SPECIFICATION

- Carrier tape and transparent cover tape should be heat-sealed to carry the products, and the reel should be used to reel the carrier tape.
- The adhesion of the heat-sealed cover tape shall be 25~60 grams with nominal of 40 grams.
- Both the head and the end portion of the taping shall be empty for reel package and SMT auto-pickup machine. And a normal paper tape shall be connected in the head of taping for the operator to handle.

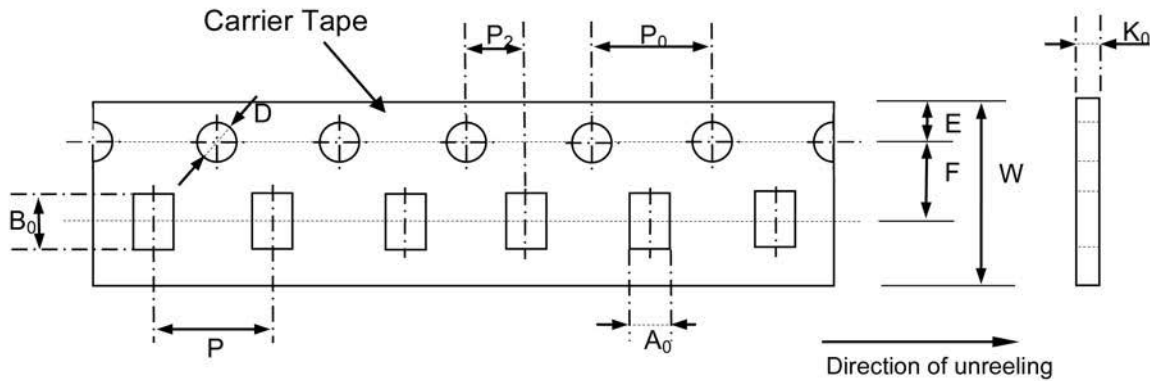

mm (inches)

Case Size	A ₀ ±0.05 (0.002)	B ₀ ±0.05 (0.002)	K ₀ ±0.05 (0.002)	D +0.10 (0.004) -0.05 (0.002)	P ±0.10 (0.004)	P ₂ ±0.10 (0.004)	P ₀ ±0.10 (0.004)	W ±0.10 (0.004)	E ±0.10 (0.004)	F ±0.05 (0.002)	Qty
0201	0.37 (0.015)	0.67 (0.026)	0.50 (0.020)	1.50 (0.059)	2.00 (0.079)	2.00 (0.079)	4.00 (0.157)	8.00 (0.315)	1.75 (0.069)	3.50 (0.138)	15K
0402	0.70 (0.028)	1.12 (0.044)	0.60 (0.024)	1.55 (0.061)	2.00 (0.079)	2.00 (0.079)	4.00 (0.157)	8.00 (0.315)	1.75 (0.069)	3.50 (0.138)	10k
0603	1.00 (0.039)	1.80 (0.071)	0.70 (0.028)	1.50 (0.059)	4.00 (0.157)	2.00 (0.079)	4.0 (0.157)	8.00 (0.315)	1.75 (0.069)	3.50 (0.138)	5K

REEL DIMENSIONS

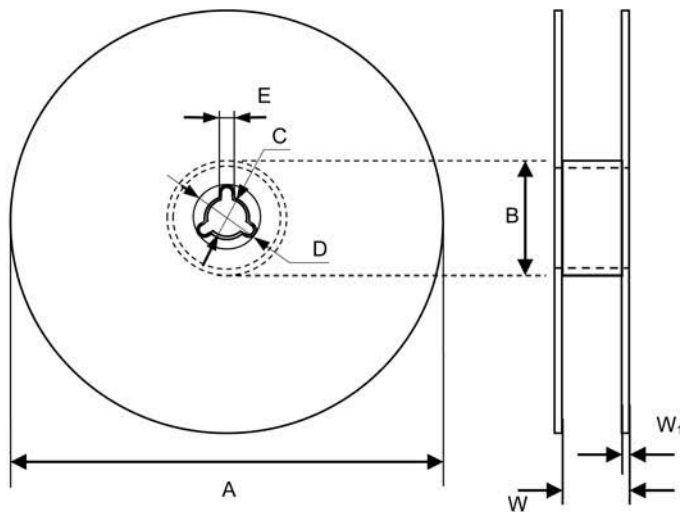

mm (inches)

Reel Size	A	B	C	D	E	W	W ₁
7"	178.0 ± 1.0 (7.008 ± 0.039)	60.0 ± 0.5 (2.362 ± 0.020)	13.0 ± 0.2 (0.512 ± 0.008)	21.0 ± 0.2 (0.827 ± 0.008)	2.0 ± 0.5 (0.079 ± 0.020)	9.0 ± 0.50 (0.354 ± 0.020)	1.5 ± 0.15 (0.059 ± 0.006)

Looking for pricing, stock, or lifecycle information?

Click below to explore more details on WIN SOURCE:

- ⊖ [View GG040205170N2P on WIN SOURCE](#)
- ⊖ [Kyocera International Inc. Electronic Components Information](#)

Optimize Your Supply Chain with WIN SOURCE Solutions

- ✓ Global Sourcing Solution
- ✓ Obsolete Management
- ✓ Cost Control Management
- ✓ Shortage Management
- ✓ Alternative Solution
- ✓ Excess Inventory Management