



THE DATASHEET OF
653102131822



1

2

3

4

5

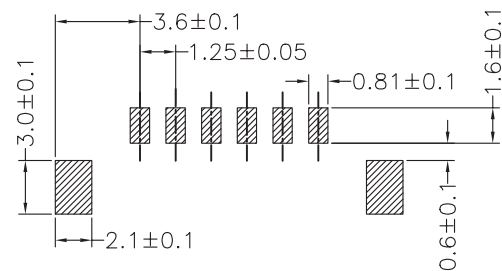

PCB LAYOUT - COMPONENT VIEW

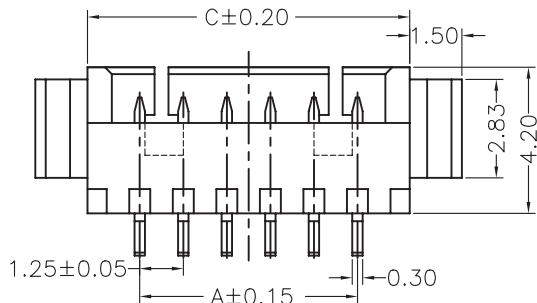
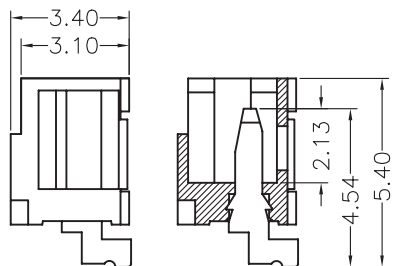
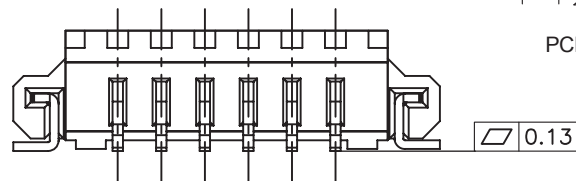

4~15P

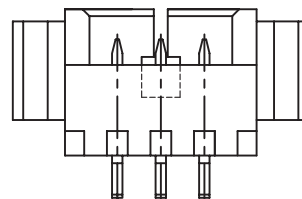

2P;3P

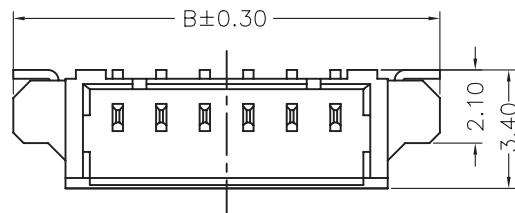

TECHNICAL CHARACTERISTICS

MATERIAL

INSULATOR: NYLON 46
 FLAMMABILITY RATING: UL94-V0
 COLOR: IVORY
 CONTACT MATERIAL: COPPER ALLOY
 CONTACT TYPE: STAMPED
 CONTACT PLATING: TIN
 QUALITY CLASS: 25 MATING CYCLES
 PITCH: 1.25 MM

ENVIRONMENTAL

OPERATING TEMPERATURE: -40 UP TO 85°C
 COMPLIANCE: LEAD FREE AND ROHS

ELECTRICAL

CURRENT RATING: 1 A
 WORKING VOLTAGE: 125 VAC
 INSULATOR RESISTANCE: >100 MOHM
 DIELECTRIC WITHSTANDING VOLTAGE: 250 VAC/MN
 CONTACT RESISTANCE: 20 mOHM MAX

SOLDERING

JEDEC LEAD FREE REFLOW SOLDERING PROCESS

PACKAGING

TAPE AND REEL

DIMENSION

A = 1.25 x (NB PIN - 1)
 B = 1.25 x (NB PIN + 1) + 3.5
 C = 1.25 x (NB PIN + 1) + 0.5

RoHS Compliant

PROJECTION:

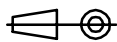

GENERAL TOLERANCE

.X = +/- 0.2

.XX = +/- 0.15



APPROVAL: BBu

UNIT: MM

SCALE:

SHEET: 1/3

DRAW: ANDY

DESCRIPTION: 1.25 MM SMT MALE HORIZONTAL SHROUDED HEADER

WERI PART NO: 653 1xx 131 822

SIZE

A4

J	28-FEB-17	TPK	AK
I	14-SEP-16	TPK	AK
H	06-AUG-15	COLOR	AK
REV	DATE	FILE	BY

1

2

3

4

5



PRODUCT:XXPCS

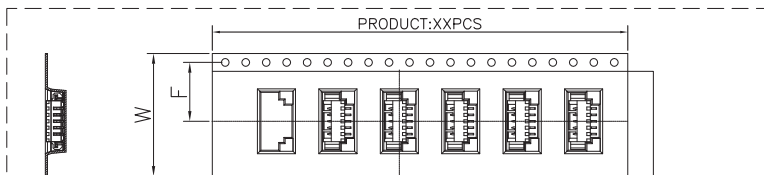

For Reel width (dimension W)16,24mm ,3 & 5PIN ONLY

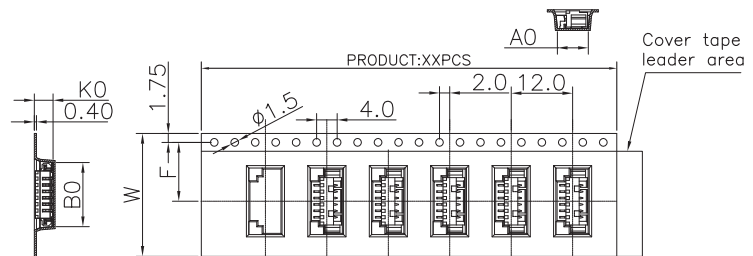

For Reel width (dimension W)16,24mm ,Single row hole

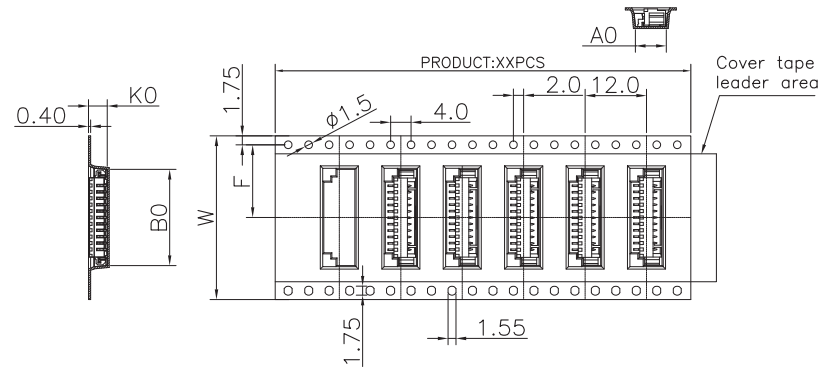

For Reel width (dimension W)32,44,56,72mm ,Double rows hole

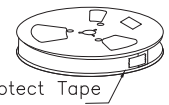
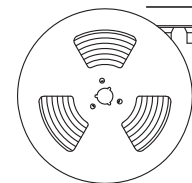
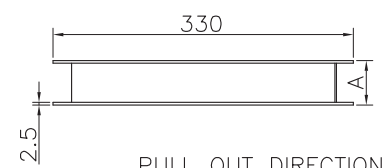

Protect Tape
Vacuum Bag

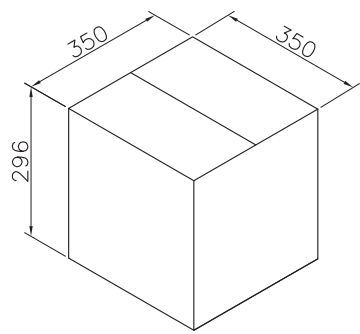
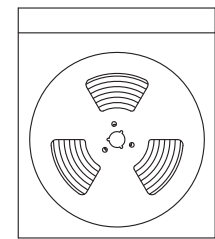

- Note:
- 1.All dimensions meet EIA-481-3 requirements.
 - 2.Material: Transparent Conductive Polystyrene Alloy 100% recyclable.
 - 3.Thickness: 0.40 ± 0.05 mm
 - 4.Component load per 13" reel:1500 pcs.
 - 5.CARTON SIZE:350*350*296(mm)
Vacuum bag:450*500*0.2(mm)

Pin No	W	F	A0	B0	K0	PCS/R	R/CTN	Q'TY
02	24	11.5	6.05	7.55	3.65	1500	9	13500
03	24	11.5	6.05	8.80	3.65	1500	9	13500
04	24	11.5	6.05	10.05	3.65	1500	9	13500
05	24	11.5	6.05	11.30	3.65	1500	9	13500
06	24	11.5	6.05	12.55	3.65	1500	9	13500
07	24	11.5	6.05	13.80	3.65	1500	9	13500
08	24	11.5	6.05	15.05	3.65	1500	9	13500
09	24	11.5	6.05	16.30	3.65	1500	9	13500
10	32	14.2	6.05	17.55	3.65	1500	7	10500
11	32	14.2	6.05	18.80	3.65	1500	7	10500
12	44	14.2	6.05	20.05	3.65	1500	5	7500
13	44	14.2	6.05	21.30	3.65	1500	5	7500
14	44	20.2	6.05	22.55	3.65	1500	5	7500
15	44	20.2	6.05	23.80	3.65	1500	5	7500

RoHS Compliant			
G			
F			
E			
D			
C			
B			
A			
REV	DATE	FILE	BY

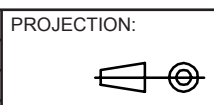

APPROVAL: BBu

GENERAL TOLERANCE
 .X = ± 0.2
 .XX = ± 0.15



UNIT: MM
 SCALE:
 SHEET: 2/3
 DRAW: PEARL

DESCRIPTION: 1.25 MM SMT MALE HORIZONTAL SHROUDED HEADER
 WERI PART NO: 653 1xx 131 822

SIZE
A4

A

B

C

D

1

2

3

4

5

Cautions and Warnings:

This electronic component is designed and developed with the intention for use in general electronics equipments.

Before incorporating the components into any equipments in the field such as aerospace, aviation, nuclear control, submarine, transportation, (automotive control, train control, ship control), transportation signal, disaster prevention, medical, public information network etc. where higher safety and reliability are especially required or if there is possibility of direct damage or injury to human body, Würth Elektronik must be asked for a written approval.



In addition, even electronic component in general electronic equipments, when used in electrical circuits that require high safety, reliability functions or performance, the sufficient reliability evaluation-check for the safety must be performed before by the user before usage.

A

B

C

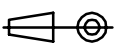
RoHS Compliant

G				PROJECTION: 	GENERAL TOLERANCE .X = +/- 0.2 .XX = +/- 0.15		
F							
E							
D							
C				APPROVAL: JC	UNIT: MM	DESCRIPTION: DISCLAIMER	SIZE A4
B					SCALE:		
A	10-SEP-14	PDF	QL		SHEET: 3/3	WERI PART NO: DISCLAIMER	
REV	DATE	FILE	BY		DRAW: QL		

D

Looking for pricing, stock, or lifecycle information?

Click below to explore more details on WIN SOURCE:

 [View 653102131822 on WIN SOURCE](#)

 [Wurth Electronics Inc Information](#)

Optimize Your Supply Chain with WIN SOURCE Solutions

-  Global Sourcing Solution
-  Obsolete Management
-  Cost Control Management
-  Shortage Management
-  Alternative Solution
-  Excess Inventory Management