

Overview

FC Series Supercapacitors, also known as Electric Double-Layer Capacitors (EDLCs), are surface mount type components intended for high energy storage applications. The FC Series is designed specifically for reflow soldering, allowing them to be attached to a printed circuit board (PCB) directly.

Applications

Supercapacitors have characteristics ranging from traditional capacitors and batteries. As a result, supercapacitors can be used like a secondary battery when applied in a DC circuit. These devices are best suited for use in low voltage DC hold-up applications such as embedded microprocessor systems with flash memory.

Benefits

- Surface mount without holder
- Wide range of temperature from -25°C to +70°C
- Maintenance free
- Maximum operating voltages of 3.5 and 5.5 VDC
- Highly reliable against liquid leakage
- Lead-free and RoHS Compliant



Part Number System

FC	0H	104	Z	F	TB	R	24	-SS
Series Surface Mount	Maximum Operating Voltage	Capacitance Code	Capacitance Tolerance	Environmental	Tape Type	Orientation	Tape Width	C-Spec
FCS FC	0V = 3.5 VDC 0H = 5.5 VDC	First two digits represent significant figures. Third digit specifies number of zeros to follow μ F code.	Z = -20/+80%	F = Lead-free	TB = Embossed	R = Positive electrode forward	24 = 24 mm 32 = 32 mm 44 = 44 mm	-SS = 3 digit serial number marked on top Blank = No serial number marking

Dimensions – Millimeters

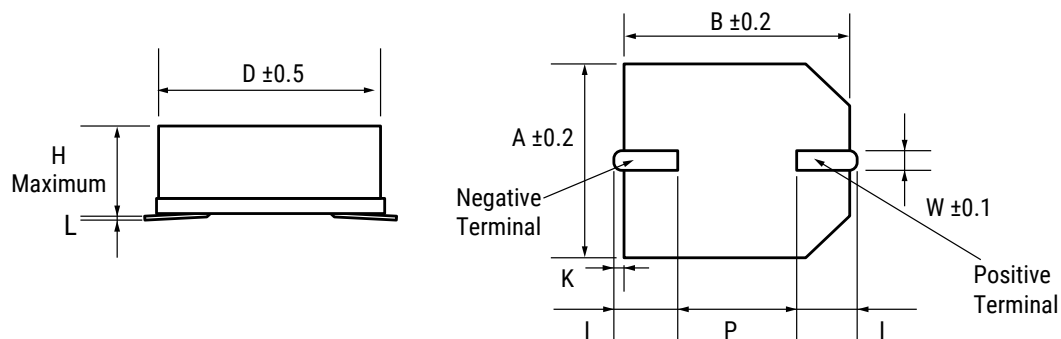

Part Number	D	H	A	B	I	W	P	K	L	Reflow Peak Temperature
FC0H473ZFTBR24	10.5	5.5	10.8	10.8	3.6±0.5	1.2	5.0	0.7±0.3	0 (+0.3/-0.1)	235°C
FC0H104ZFTBR24	10.5	5.5	10.8	10.8	3.6±0.5	1.2	5.0	0.7±0.3	0 (+0.3/-0.1)	235°C
FC0H224ZFTBR24	10.5	8.5	10.8	10.8	3.6±0.5	1.2	5.0	0.7±0.3	0 (+0.3/-0.1)	235°C
FC0H474ZFTBR32-SS	16.0	9.5	16.3	16.3	6.8±1.0	1.2	5.0	1.2±0.5	0 (+0.5/-0.1)	235°C
FC0H105ZFTBR44-SS	21.0	10.5	21.6	21.6	7.0±1.0	1.4	10.0	1.2±0.5	0 (+0.5/-0.1)	235°C
FC0V104ZFTBR24	10.5	5.5	10.8	10.8	3.6±0.5	1.2	5.0	0.7±0.3	0 (+0.3/-0.1)	235°C
FC0V224ZFTBR24	10.5	5.5	10.8	10.8	3.6±0.5	1.2	5.0	0.7±0.3	0 (+0.3/-0.1)	235°C
FC0V474ZFTBR24	10.5	8.5	10.8	10.8	3.6±0.5	1.2	5.0	0.7±0.3	0 (+0.3/-0.1)	235°C
FCS0H473ZFTBR24	10.7	5.5	10.8	10.8	3.9±0.5	1.2	5.0	0.9±0.3	0 (+0.3/-0.1)	260°C
FCS0H104ZFTBR24	10.7	5.5	10.8	10.8	3.9±0.5	1.2	5.0	0.9±0.3	0 (+0.3/-0.1)	260°C
FCS0H224ZFTBR24	10.7	8.5	10.8	10.8	3.9±0.5	1.2	5.0	0.9±0.3	0 (+0.3/-0.1)	260°C
FCS0V104ZFTBR24	10.7	5.5	10.8	10.8	3.9±0.5	1.2	5.0	0.9±0.3	0 (+0.3/-0.1)	260°C
FCS0V224ZFTBR24	10.7	5.5	10.8	10.8	3.9±0.5	1.2	5.0	0.9±0.3	0 (+0.3/-0.1)	260°C
FCS0V474ZFTBR24	10.7	8.5	10.8	10.8	3.9±0.5	1.2	5.0	0.9±0.3	0 (+0.3/-0.1)	260°C

Performance Characteristics

Supercapacitors should not be used for applications such as ripple absorption because of their high internal resistance (several hundred mΩ to a hundred Ω) compared to aluminum electrolytic capacitors. Thus, its main use would be similar to that of secondary battery such as power back-up in DC circuit. The following list shows the characteristics of supercapacitors as compared to aluminum electrolytic capacitors for power back-up and secondary batteries.

	Secondary Battery		Capacitor	
	NiCd	Lithium Ion	Aluminum Electrolytic	Supercapacitor
Back-up ability	-	-	-	-
Eco-hazard	Cd	-	-	-
Operating Temperature Range	-20 to +60°C	-20 to +50°C	-55 to +105°C	-40 to +85°C (FR, FT, FMR type)
Charge Time	Few hours	Few hours	Few seconds	Few seconds
Charge/Discharge Life Time	Approximately 500 times	Approximately 500 to 1,000 times	Limitless (*1)	Limitless (*1)
Restrictions on Charge/Discharge	Yes	Yes	None	None
Flow Soldering	Not applicable	Not applicable	Applicable	Applicable
Automatic Mounting	Not applicable	Not applicable	Applicable	Applicable (FM and FC series)
Safety Risks	Leakage, explosion	Leakage, combustion, explosion, ignition	Heat-up, explosion	Gas emission (*2)

(*1) Aluminum electrolytic capacitors and supercapacitors have limited lifetime. However, when used under proper conditions, both can operate within a predetermined lifetime.

(*2) There is no harm as it is a mere leak of water vapor which transitioned from water contained in the electrolyte (diluted sulfuric acid). However, application of abnormal voltage surge exceeding maximum operating voltage may result in leakage and explosion.

Typical Applications

Intended Use (Guideline)	Power Supply (Guideline)	Application	Examples of Equipment	Series
Long time back-up	500 μA and below	CMOS microcomputer, IC for clocks	CMOS microcomputer, static RAM/DTS (digital tuning system)	FC series

Environmental Compliance

All KEMET supercapacitors are RoHS Compliant.

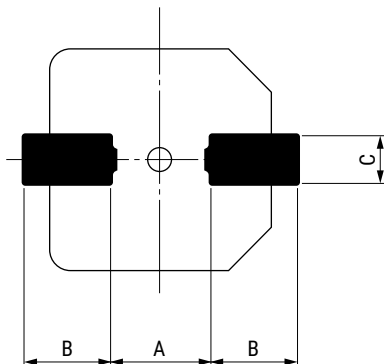

Table 1 – Ratings & Part Number Reference

Part Number	Maximum Operating Voltage (VDC)	Nominal Capacitance Discharge System (F)	Maximum ESR at 1 kHz (Ω)	Maximum Current at 30 Minutes (mA)	Voltage Holding Characteristic Minimum (V)	Weight (g)
FC0V104ZFTBR24	3.5	0.10	50	0.09	–	1.0
FCS0V104ZFTBR24	3.5	0.10	100	0.09	–	1.0
FC0V224ZFTBR24	3.5	0.22	25	0.20	–	1.0
FCS0V224ZFTBR24	3.5	0.22	50	0.20	–	1.0
FC0V474ZFTBR24	3.5	0.47	25	0.42	–	1.4
FCS0V474ZFTBR24	3.5	0.47	50	0.42	–	1.4
FC0H473ZFTBR24	5.5	0.047	50	0.071	4.2	1.0
FCS0H473ZFTBR24	5.5	0.047	100	0.071	4.2	1.0
FC0H104ZFTBR24	5.5	0.10	25	0.15	4.2	1.0
FCS0H104ZFTBR24	5.5	0.10	50	0.15	4.2	1.0
FC0H224ZFTBR24	5.5	0.22	25	0.33	4.2	1.4
FCS0H224ZFTBR24	5.5	0.22	50	0.33	4.2	1.4
FC0H474ZFTBR32-SS	5.5	0.47	13	0.71	4.2	4.0
FC0H105ZFTBR44-SS	5.5	1.0	7	1.50	4.2	6.7

Part numbers in bold type represent popularly purchased components.

Land Pattern



Diameter (mm)	Land Pattern			Lead Terminal		
	A	B	C	A	B	C
10.5	5.0	4.9	2.5	5.0	3.6	1.2
10.7	5.0	4.9	2.5	5.0	3.9	1.2
16	5.0	10.0	2.5	5.0	6.8	1.2
21	10.0	10.5	3.5	10.0	7.0	1.4

Precautions for Use

- This series is exclusively for reflow soldering. It is designed for thermal conduction system such as combination use of infrared ray and heat blow. Consult with KEMET before applying other methods.
- The reflow condition must be kept within reflow profile graphs shown below.
- Applying reflow soldering is limited to 2 times. After the first reflow, cool down the capacitor thoroughly to 5 – 35°C before the second reflow.

Always consult with KEMET when applying reflow soldering in a more severe condition than the condition described here.

FCS Type

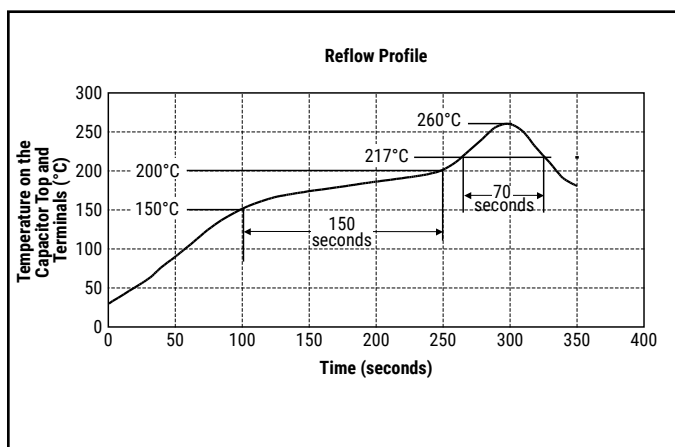

Above "Reflow Profile" graph indicates temperature at the terminals and capacitor top.

FC Type

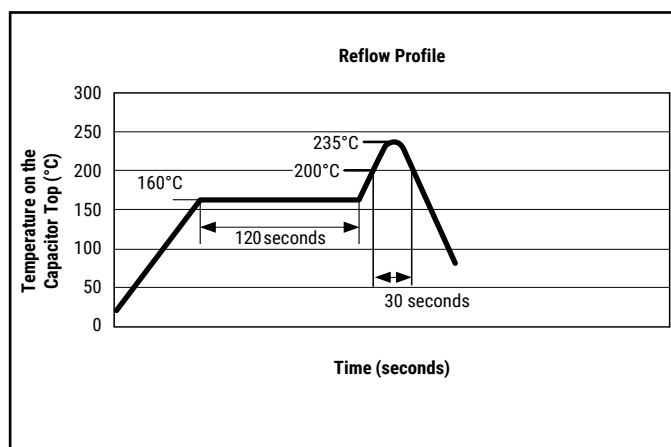

Above "Reflow Profile" graph indicates temperature at capacitor top.

Peak Temperature	Below +260°C
Over +255°C	Within 10 seconds
Over +230°C	Within 45 seconds
Over +220°C	Within 60 seconds
Over +217°C	Within 70 seconds
Time between +150°C to +200°C (temperature zone over +170°C within 50 seconds)	150 seconds

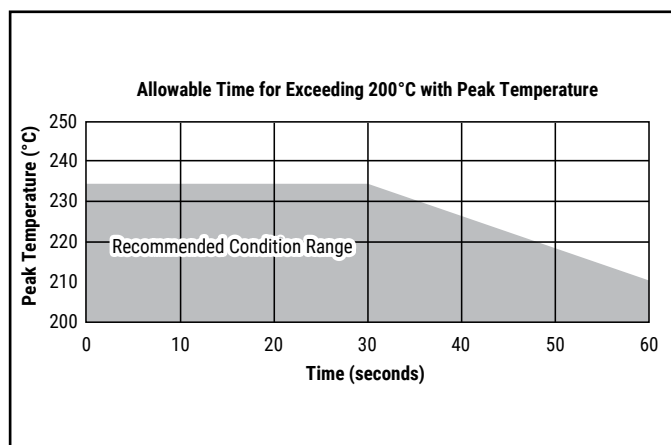

Specifications

Item		FC 5.5 V Type, 3.5 V Type		Test Conditions (conforming to JIS C 5160-1)
Category Temperature Range		-25°C to +70°C		
Maximum Operating Voltage		5.5 VDC, 3.5 VDC		
Capacitance		Refer to Table 1		Refer to "Measurement Conditions"
Capacitance Allowance		+80%, -20%		Refer to "Measurement Conditions"
ESR		Refer to Table 1		Measured at 1 kHz, 10 mA; See also "Measurement Conditions"
Current (30 minutes value)		Refer to Table 1		Refer to "Measurement Conditions"
* Surge	Capacitance	> 90% of initial ratings		Surge voltage: 4.0 V (3.5 V type, 3.6 V type) Charge: 6.3 V (5.5 V type) Discharge: 30 seconds Number of cycles: 9 minutes 30 seconds Series resistance: 1,000 0.043 F, 0.047 F 300 Ω 0.068 F 240 Ω 0.10 F 150 Ω 0.22 F 56 Ω 0.47 F 30 Ω 1.0 F 15 Ω Discharge Resistance: 0 Ω Temperature: 70 ±2°C
	ESR	≤ 120% of initial ratings		
	Current (30 minutes value)	≤ 120% of initial ratings		
	Appearance	No obvious abnormality		
* Characteristics in Different Temperature	Capacitance	Phase 2	≥ 50% of initial value	Conforms to 4.17 Phase 1: +25 ±2°C Phase 2: -25 ±2°C Phase 4: +25 ±2°C Phase 5: +70 ±2°C Phase 6: +25 ±2°C
	ESR		≤ 400% of initial value	
	Capacitance	Phase 3		
	ESR			
	Capacitance	Phase 5	≤ 200% of initial value	
	ESR		Satisfy initial ratings	
	Current (30 minutes value)		1.5 CV (mA) or below	
	Capacitance	Phase 6	Within ±20% of initial value	
	ESR		Satisfy initial ratings	
Current (30 minutes value)	Satisfy initial ratings			
* Vibration Resistance	Capacitance	Satisfy initial ratings		Conforms to 4.13 Frequency: 10 to 55 Hz Testing Time: 6 hours
	ESR			
	Current (30 minutes value)			
	Appearance	No obvious abnormality		
* Solder Heat Resistance	Capacitance	Satisfy initial ratings		Cooled down to ambient temperature after reflow soldering, then the product must fulfill the condition stated left. (See Precautions for Use)
	ESR			
	Current (30 minutes value)			
	Appearance	No obvious abnormality		
* Temperature Cycle	Capacitance	Satisfy initial ratings		Conforms to 4.12 Temperature Condition: -25°C » Room temperature » +70°C » Room temperature Number of cycles: 5 cycles
	ESR			
	Current (30 minutes value)			
	Appearance	No obvious abnormality		

* Must fulfill the above condition after reflow soldering.

Specifications cont.

Item		FC 5.5 V Type, 3.5 V Type	Test Conditions (conforming to JIS C 5160-1)
* High Temperature and High Humidity Resistance	Capacitance	Within $\pm 20\%$ of initial value	Conforms to 4.14 Temperature: $+40 \pm 2^\circ\text{C}$ Relative humidity: 90 to 95% RH Testing time: 240 ± 8 hours
	ESR	$\leq 120\%$ of initial ratings	
	Current (30 minutes value)	$\leq 120\%$ of initial ratings	
	Appearance	No obvious abnormality	
* High Temperature Load	Capacitance	Within $\pm 30\%$ of initial value	Conforms to 4.15 Voltage applied: Maximum operating voltage Series protection resistance: 0Ω Testing time: 1,000 +48 (+48/-0) hours
	ESR	$< 200\%$ of initial ratings	
	Current (30 minutes value)	$< 200\%$ of initial ratings	
	Appearance	No obvious abnormality	
* Self Discharge Characteristics (Voltage Holding Characteristics)	5.5 V type:	Voltage between terminal leads $> 4.2 \text{ V}$	Charging condition Voltage applied: 5.0 VDC (Terminal at the case side must be negative) Series resistance: 0Ω Charging time: 24 hours
	3.5 V type:	Not specified	Storage Let stand for 24 hours in condition described below with terminals opened. Ambient temperature: $< 25^\circ\text{C}$ Relative humidity: $< 70\% \text{ RH}$

* Must fulfill the above condition after reflow soldering.

Construction

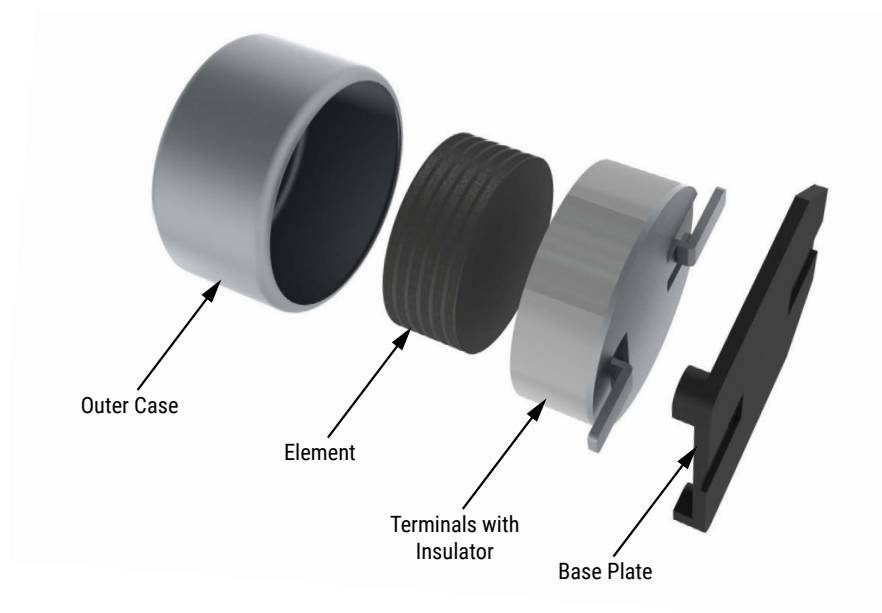

Marking

D = 10.5 mm



D = 16 & 21 mm

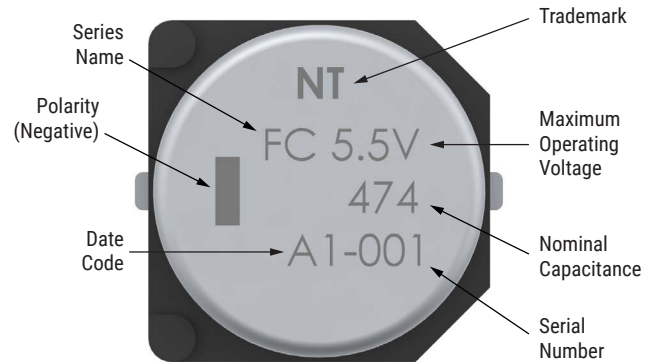

D = 10.7 mm

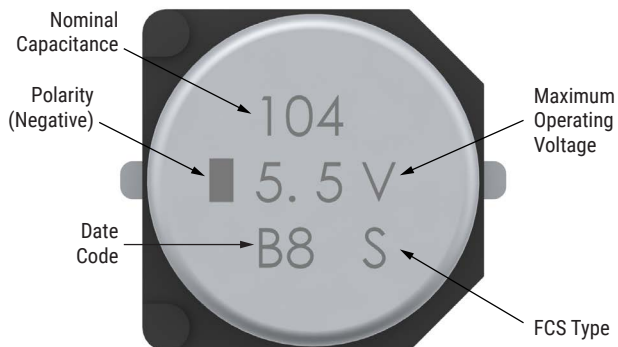

Displays nominal capacitance, maximum operating voltage serial number, polarity, etc.

Tape & Reel Packaging Information – Millimeters

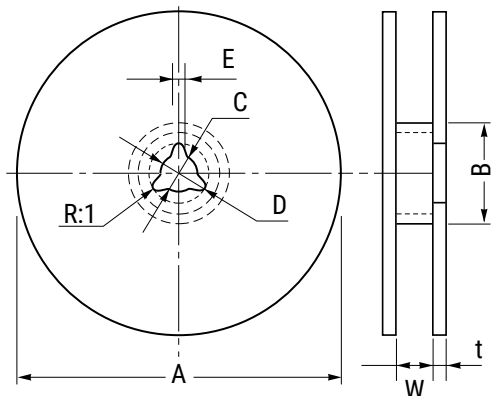

Mark	TBR24		TBR32	TBR44
A	380±2		330±2	380±2
B	Product height 5.5 mm	80±1	100±1	100±1
	Product height 8.5 mm	100±1		
C	13±0.5		13±0.5	13±0.5
D	21±0.8		21±0.8	21±0.8
E	2±0.5		2±0.5	2±0.5
W	Product height 5.5 mm	25.5±0.5	33.5±1.0	45.5±1.0
	Product height 8.5 mm	25.5±1.0		
t	2.0		2.0	2.0

Tape & Reel Packaging Information – Millimeters cont.

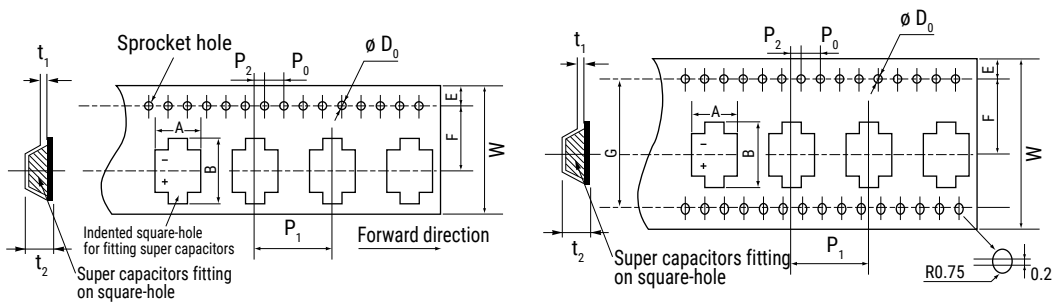

Mark	TBR24	TBR32	TBR44
W	24.0	32.0	44.0
A	11.4	18.0	23.0
B	13.0	20.0	25.0
P ₀	4.0	4.0	4.0
P ₁	16.0	24.0	32.0
P ₂	2.0	2.0	2.0
F	11.5	14.2	20.2
ø D ₀	1.55	1.55	1.55
t ₁	0.4	0.5	0.5
E	1.75	1.75	1.75
t ₂	Product height 5.5 mm	6.0	10.0
	Product height 8.5 mm	8.4	12.0
G	-	28.4	40.4

Ammo Pack Packaging Information

Part Number	Quantity per Reel
FC0H473ZFTBR24	1,000 pieces/reel
FC0H104ZFTBR24	1,000 pieces/reel
FC0H224ZFTBR24	500 pieces/reel
FC0H474ZFTBR32-SS	200 pieces/reel
FC0H105ZFTBR44-SS	150 pieces/reel
FC0V104ZFTBR24	1,000 pieces/reel
FC0V224ZFTBR24	1,000 pieces/reel
FC0V474ZFTBR24	500 pieces/reel
FCS0H473ZFTBR24	1,000 pieces/reel
FCS0H104ZFTBR24	1,000 pieces/reel
FCS0H224ZFTBR24	500 pieces/reel
FCS0V104ZFTBR24	1,000 pieces/reel
FCS0V224ZFTBR24	1,000 pieces/reel
FCS0V474ZFTBR24	500 pieces/reel

Measurement Conditions

Capacitance (Charge System)

Capacitance is calculated from expression (9) by measuring the charge time constant (τ) of the capacitor (C). Prior to measurement, the capacitor is discharged by shorting both pins of the device for at least 30 minutes. In addition, use the polarity indicator on the device to determine correct orientation of capacitor for charging.

$$\text{Capacitance: } C = \frac{\tau}{R_c} \text{ (F) (9)}$$

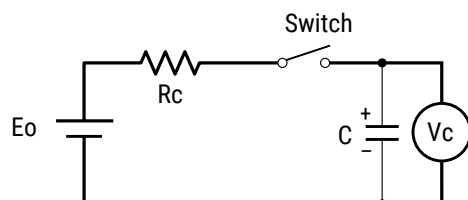

Eo: 3.0 (V) Product with maximum operating voltage of 3.5 V
 5.0 (V) Product with maximum operating voltage of 5.5 V
 6.0 (V) Product with maximum operating voltage of 6.5 V
 10.0 (V) Product with maximum operating voltage of 11 V
 12.0 (V) Product with maximum operating voltage of 12 V
 τ : Time from start of charging until V_c becomes 0.632 E_o (V)
 (seconds)
 R_c : See table below (Ω).

Charge Resistor Selection Guide

Cap	FA	FE	FS	FY		FR	FM, FME FMR	FMC	FG, FGR	FGH	FT	FC, FCS	HV
				FYD	FYH								
0.010 F	-	-	-	-	-	-	5,000 Ω	-	5,000 Ω	-	-	-	-
0.022 F	1,000 Ω	-	1,000 Ω	2,000 Ω	2,000 Ω	2,000 Ω	2,000 Ω	-	2,000 Ω	-	-	Discharge	-
0.033 F	-	-	-	-	-	-	Discharge	-	-	-	-	-	-
0.047 F	1,000 Ω	1,000 Ω	1,000 Ω	2,000 Ω	1,000 Ω	1,000 Ω	2000 Ω	1,000 Ω	2,000 Ω	-	-	-	-
0.10 F	510 Ω	510 Ω	510 Ω	1,000 Ω	510 Ω	1,000 Ω	1000 Ω	1,000 Ω	1,000 Ω	Discharge	510 Ω	Discharge	-
0.22 F	200 Ω	200 Ω	200 Ω	510 Ω	510 Ω	510 Ω	0H: Discharge 0V: 1000 Ω	-	1,000 Ω	Discharge	200 Ω	Discharge	-
0.33 F	-	-	-	-	-	-	-	Discharge	-	-	-	-	-
0.47 F	100 Ω	100 Ω	100 Ω	200 Ω	200 Ω	200 Ω	-	-	1,000 Ω	Discharge	100 Ω	Discharge	-
1.0 F	51 Ω	51 Ω	100 Ω	100 Ω	100 Ω	100 Ω	-	-	510 Ω	Discharge	100 Ω	Discharge	Discharge
1.4 F	-	-	-	200 Ω	-	-	-	-	-	-	-	-	-
1.5 F	-	51 Ω	-	-	-	-	-	-	510 Ω	-	-	-	-
2.2 F	-	-	-	100 Ω	-	-	-	-	200 Ω	-	51 Ω	-	-
2.7 F	-	-	-	-	-	-	-	-	-	-	-	-	Discharge
3.3 F	-	-	-	-	-	-	-	-	-	-	51 Ω	-	-
4.7 F	-	-	-	-	-	-	-	-	100 Ω	-	-	-	Discharge
5.0 F	-	-	100 Ω	-	-	-	-	-	-	-	-	-	-
5.6 F	-	-	-	-	-	-	-	-	-	-	20 Ω	-	-
10.0 F	-	-	-	-	-	-	-	-	-	-	-	-	Discharge
22.0 F	-	-	-	-	-	-	-	-	-	-	-	-	Discharge
50.0 F	-	-	-	-	-	-	-	-	-	-	-	-	Discharge
100.0 F	-	-	-	-	-	-	-	-	-	-	-	-	Discharge
200.0 F	-	-	-	-	-	-	-	-	-	-	-	-	Discharge

*Capacitance values according to the constant current discharge method.

*HV Series capacitance is measured by discharge system.

Measurement Conditions cont.

Capacitance (Discharge System)

As shown in the diagram below, charging is performed for a duration of 30 minutes once the voltage of the capacitor terminal reaches 5.5 V. Then, use a constant current load device and measure the time for the terminal voltage to drop from 3.0 to 2.5 V upon discharge at 0.22 mA per 0.22 F, for example, and calculate the static capacitance according to the equation shown below.

Note: The current value is 1 mA discharged per 1 F.

$$C = \frac{I \times (T_2 - T_1)}{V_1 - V_2} \text{ (F)}$$

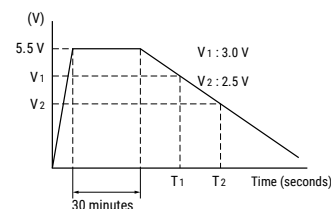
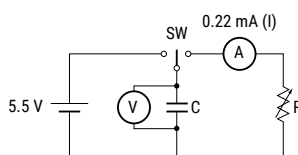

Capacitance (Discharge System – 3.5 V, 3.6 V)

As shown in the diagram below, charging is performed for a duration of 30 minutes once the voltage of the capacitor terminal reaches 3.5 V (3.6 V). Then, use a constant current load device and measure the time for the terminal voltage to drop from 1.8 to 1.5 V upon discharge at 1.0 mA per 1.0 F, for example, and calculate the static capacitance according to the equation shown below.

$$C = \frac{I \times (T_2 - T_1)}{V_1 - V_2} \text{ (F)}$$

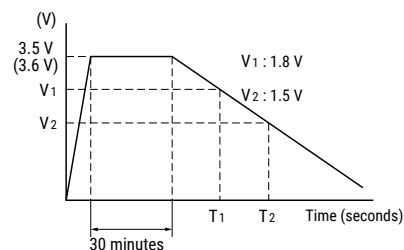
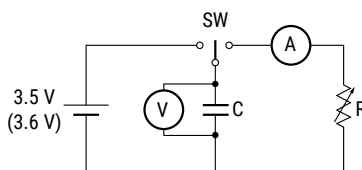

Capacitance (Discharge System – HV Series)

As shown in the diagram below, charging is performed for a duration of 30 minutes once the voltage of the capacitor terminal reaches maximum operating voltage. Then, use a constant current load device and measure the time for the terminal voltage to drop from 2.0 to 1.5 V upon discharge at 1.0 mA per 1.0 F, and calculate the static capacitance according to the equation shown below.

$$C = \frac{I \times (T_2 - T_1)}{V_1 - V_2} \text{ (F)}$$

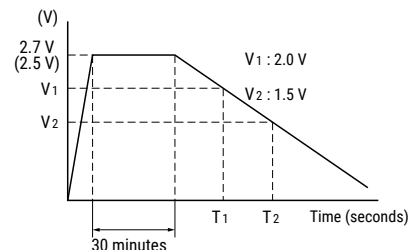
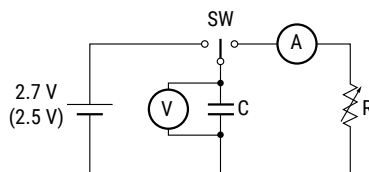

Measurement Conditions cont.

Equivalent Series Resistance (ESR)

ESR shall be calculated from the equation below.

$$ESR = \frac{V_C}{0.01} (\Omega)$$

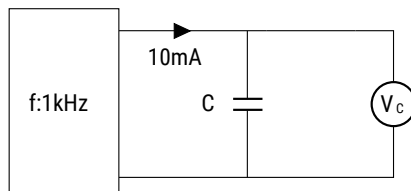

Current (at 30 minutes after charging)

Current shall be calculated from the equation below. Prior to measurement, both lead terminals must be short-circuited for a minimum of 30 minutes. The lead terminal connected to the metal can case is connected to the negative side of the power supply.

Eo: 2.5 VDC (HV Series 50 F)
 2.7 VDC (HV Series except 50 F)
 3.0 VDC (3.5 V type)
 3.6 VDC (3.6 V type)
 5.0 VDC (5.5 V type)
 6.0 VDC (6.5 V type)
 10.0 VDC (11 V type)
 12.0 VDC (12 V type)

$$\text{Current} = \frac{V_R}{R_C} (\text{A})$$

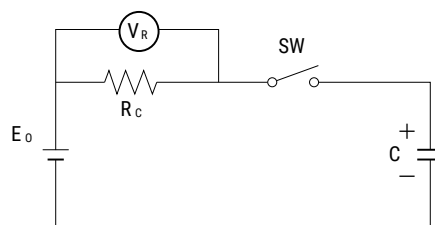

Rc: 1,000 Ω (0.01 F, 0.022 F, 0.047 F)
 100 Ω (0.10 F, 0.22 F, 0.33 F, 0.47 F)
 10 Ω (1.0 F, 1.4 F, 1.5 F, 2.2 F, 3.3 F, 4.7 F, 5.6 F)
 2.2 Ω (HV Series)
 However, FS Series 11 V type and 12 V type
 100 Ω 0.47 F, 1.0 F
 10 Ω 5.0 F

Self-Discharge Characteristic (0H – 5.5 V Products)

The self-discharge characteristic is measured by charging a voltage of 5.0 VDC (charge protection resistance: 0 Ω) according to the capacitor polarity for 24 hours, then releasing between the pins for 24 hours and measuring the pin-to-pin voltage. The test should be carried out in an environment with an ambient temperature of 25° C or below and relative humidity of 70% RH or below. The soldering is checked.

4. Dismantling

There is a small amount of electrolyte stored within the capacitor. Do not attempt to dismantle as direct skin contact with the electrolyte will cause burning. This product should be treated as industrial waste and not is not to be disposed of by fire.

Notes on Using Supercapacitors or Electric Double-Layer Capacitors (EDLCs)

1. Circuitry Design

1.1 Useful life

The FC Series Supercapacitor (EDLC) uses an electrolyte in a sealed container. Water in the electrolyte can evaporate while in use over long periods of time at high temperatures, thus reducing electrostatic capacity which in turn will create greater internal resistance. The characteristics of the supercapacitor can vary greatly depending on the environment in which it is used. Basic breakdown mode is an open mode due to increased internal resistance.

1.2 Fail rate in the field

Based on field data, the fail rate is calculated at approximately 0.006 Fit. We estimate that unreported failures are ten times this amount. Therefore, we assume that the fail rate is below 0.06 Fit.

1.3 Exceeding maximum usable voltage

Performance may be compromised and in some cases leakage or damage may occur if applied voltage exceeds maximum working voltage.

1.4 Use of capacitor as a smoothing capacitor (ripple absorption)

As supercapacitors contain a high level of internal resistance, they are not recommended for use as smoothing capacitors in electrical circuits. Performance may be compromised and, in some cases, leakage or damage may occur if a supercapacitor is used in ripple absorption.

1.5 Series connections

As applied voltage balance to each supercapacitor is lost when used in series connection, excess voltage may be applied to some supercapacitors, which will not only negatively affect its performance but may also cause leakage and/or damage. Allow ample margin for maximum voltage or attach a circuit for applying equal voltage to each supercapacitor (partial pressure resistor/voltage divider) when using supercapacitors in series connection. Also, arrange supercapacitors so that the temperature between each capacitor will not vary.

1.6 Case Polarity

The supercapacitor is manufactured so that the terminal on the outer case is negative (-). Align the (-) symbol during use. Even though discharging has been carried out prior to shipping, any residual electrical charge may negatively affect other parts.

1.7 Use next to heat emitters

Useful life of the supercapacitor will be significantly affected if used near heat emitting items (coils, power transistors and posistors, etc.) where the supercapacitor itself may become heated.

1.8 Usage environment

This device cannot be used in any acidic, alkaline or similar type of environment.

Notes on Using Supercapacitors or Electric Double-Layer Capacitors (EDLCs) cont.

2. Mounting

2.1 Mounting onto a reflow furnace

Except for the FC series, it is not possible to mount this capacitor onto an IR / VPS reflow furnace. Do not immerse the capacitor into a soldering dip tank.

2.2 Flow soldering conditions

Keep solder under 260°C and soldering time to within 10 seconds when using the flow automatic soldering method. (Except for the FC and HV series)

2.3 Installation using a soldering iron

Care must be taken to prevent the soldering iron from touching other parts when soldering. Keep the tip of the soldering iron under 400°C and soldering time to within 3 seconds. Always make sure that the temperature of the tip is controlled. Internal capacitor resistance is likely to increase if the terminals are overheated.

2.4 Lead terminal processing

Do not attempt to bend or polish the capacitor terminals with sand paper, etc. Soldering may not be possible if the metallic plating is removed from the top of the terminals.

2.5 Cleaning, Coating, and Potting

Except for the FM series, cleaning, coating and potting must not be carried out. Consult KEMET if this type of procedure is necessary. Terminals should be dried at less than the maximum operating temperature after cleaning.

3. Storage

3.1 Temperature and humidity

Make sure that the supercapacitor is stored according to the following conditions: Temperature: 5 – 35°C (Standard 25°C), Humidity: 20 – 70% (Standard: 50%). Do not allow the build up of condensation through sudden temperature change.

3.2 Environment conditions

Make sure there are no corrosive gasses such as sulfur dioxide, as penetration of the lead terminals is possible. Always store this item in an area with low dust and dirt levels. Make sure that the packaging will not be deformed through heavy loading, movement and/or knocks. Keep out of direct sunlight and away from radiation, static electricity and magnetic fields.

3.3 Maximum storage period

This item may be stored up to one year from the date of delivery if stored at the conditions stated above.

KEMET Electronics Corporation Sales Offices

For a complete list of our global sales offices, please visit www.kemet.com/sales.

Disclaimer

YAGEO Corporation and its affiliates do not recommend the use of commercial or automotive grade products for high reliability applications or manned space flight.

All product specifications, statements, information and data (collectively, the "Information") in this datasheet are subject to change. The customer is responsible for checking and verifying the extent to which the Information contained in this publication is applicable to an order at the time the order is placed. All Information given herein is believed to be accurate and reliable, but it is presented without guarantee, warranty, or responsibility of any kind, expressed or implied.

Statements of suitability for certain applications are based on KEMET Electronics Corporation's ("KEMET") knowledge of typical operating conditions for such applications, but are not intended to constitute – and KEMET specifically disclaims – any warranty concerning suitability for a specific customer application or use. The Information is intended for use only by customers who have the requisite experience and capability to determine the correct products for their application. Any technical advice inferred from this Information or otherwise provided by KEMET with reference to the use of KEMET's products is given gratis, and KEMET assumes no obligation or liability for the advice given or results obtained.

Although KEMET designs and manufactures its products to the most stringent quality and safety standards, given the current state of the art, isolated component failures may still occur. Accordingly, customer applications which require a high degree of reliability or safety should employ suitable designs or other safeguards (such as installation of protective circuitry or redundancies) in order to ensure that the failure of an electrical component does not result in a risk of personal injury or property damage.



Although all product-related warnings, cautions and notes must be observed, the customer should not assume that all safety measures are indicated or that other measures may not be required.

When providing KEMET products and technologies contained herein to other countries, the customer must abide by the procedures and provisions stipulated in all applicable export laws and regulations, including without limitation the International Traffic in Arms Regulations (ITAR), the US Export Administration Regulations (EAR) and the Japan Foreign Exchange and Foreign Trade Act.

KEMET is a registered trademark of KEMET Electronics Corporation.

Looking for pricing, stock, or lifecycle information?

Click below to explore more details on WIN SOURCE:

-  [View FCS0H473ZFTBR24 on WIN SOURCE](#)
-  [Kemet Information](#)

Optimize Your Supply Chain with WIN SOURCE Solutions

-  Global Sourcing Solution
-  Obsolete Management
-  Cost Control Management
-  Shortage Management
-  Alternative Solution
-  Excess Inventory Management