



THE DATASHEET OF BD5291G-GTL



Operational Amplifiers

Input/Output Full Swing Low Input Offset Voltage Operational Amplifier

BD5291xxx

General Description

The BD5291xxx is ideally suited for sensor signal conditioning. This features input/output full-swing operation with a supply voltage as low as 1.7V. In addition, high common-mode rejection ratio, ultra low input bias current (1pA typical) and low input offset voltage increase the precision that can be achieved using these operational amplifiers.

Features

- Low Operating Supply Voltage
- Input Output Full Swing
- Low Input Offset Voltage
- High Common Mode Rejection Ratio
- High Slew Rate

Applications

- Buffer
- Active Filter
- Sensor Amplifier
- Mobile Equipment

Key Specifications

- Operating Supply Voltage (Single Supply): +1.7V to +5.5V
- Slew Rate: 2.5V/μs(Typ.)
- Operating Temperature Range: -40°C to +85°C
- Input Voltage Range: VSS to VDD
- Input Offset Voltage: ±2.5mV (Max)
- Common Mode Rejection Ratio: 70dB (Min)

Package

SSOP5 W(Typ) x D(Typ) x H(Max)
VSOF5 2.90mm x 2.80mm x 1.25mm
 1.60mm x 1.60mm x 0.60mm

Pin Configuration

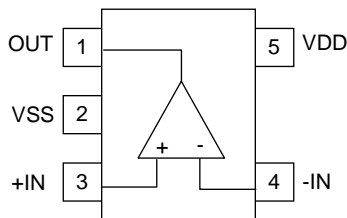

Pin No.	Pin Name
1	OUT
2	VSS
3	+IN
4	-IN
5	VDD

BD5291FVE : VSOF5

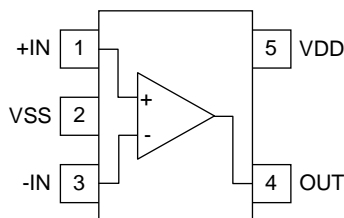

Pin No.	Pin Name
1	+IN
2	VSS
3	-IN
4	OUT
5	VDD

Figure 1. Pin Configuration

Package	
SSOP5	VSOF5
BD5291G	BD5291FVE

Ordering Information

B	D	5	2	9	1	x	x	x	-	T	x
Part Number BD5291G BD5291FVE						Package G :SSOP5 FVE :VSOF5			Packaging and forming specification TL: Embossed tape and reel (SSOP5) TR: Embossed tape and reel (VSOF5)		

Line-up

Topr	Package		Operable Part Number
-40°C to +85°C	SSOP5	Reel of 3000	BD5291G-TL
	VSOF5	Reel of 3000	BD5291FVE-TR

Absolute Maximum Ratings($T_A=25^\circ\text{C}$)

Parameter	Symbol	Ratings	Unit	
Supply voltage	VDD-VSS	+7	V	
Power dissipation	P_D	SSOP5	0.67 ^(Note 1,3)	W
		VSOF5	0.25 ^(Note 2,3)	
Differential input voltage ^(Note 4)	V_{ID}	VDD - VSS	V	
Input common-mode voltage range	V_{ICM}	(VSS - 0.3) to (VDD + 0.3)	V	
Input current ^(Note 5)	I_I	±10	mA	
Operating supply voltage	V_{opr}	+1.7 to +5.5	V	
Operating temperature	T_{opr}	- 40 to +85	°C	
Storage temperature	T_{stg}	- 55 to +150	°C	
Maximum junction temperature	T_{Jmax}	+150	°C	

(Note 1) To use at temperature above $T_A=25^\circ\text{C}$ reduce 5.4mW/°C.

(Note 2) To use at temperature above $T_A=25^\circ\text{C}$ reduce 2.0mW/°C.

(Note 3) Mounted on a FR4 glass epoxy PCB 70mm×70mm×1.6mm (Copper foil area less than 3%).

(Note 4) The voltage difference between inverting input and non-inverting input is the differential input voltage. Then input pin voltage is set to more than VSS.

(Note 5) An excessive input current will flow when input voltages of more than VDD+0.6V or less than VSS-0.6V are applied. The input current can be set to less than the rated current by adding a limiting resistor.

Caution: Operating the IC over the absolute maximum ratings may damage the IC. The damage can either be a short circuit between pins or an open circuit between pins and the internal circuitry. Therefore, it is important to consider circuit protection measures, such as adding a fuse, in case the IC is operated over the absolute maximum ratings.

Electrical Characteristics

OBD5291G (Unless otherwise specified VDD=+3.3V, VSS=0V, T_A=25°C)

Parameter	Symbol	Temperature Range	Limits			Unit	Condition
			Min	Typ	Max		
Input offset voltage ^(Note 6,7)	V _{IO}	25°C	-	0.1	2.5	mV	VDD=+1.8V, +3.3V
		Full range	-	-	3.8		
Input offset voltage drift ^(Note 6,7)	ΔV _{IO} /ΔT	Full range	-	0.8	-	μV/°C	-
Input offset current ^(Note 6,7)	I _{IO}	25°C	-	1	220	pA	-
		Full range	-	-	1700		
Input bias current ^(Note 6,7)	I _B	25°C	-	1	220	pA	-
		Full range	-	-	1700		
Supply current ^(Note 7)	I _{DD}	25°C	-	650	900	μA	R _L =∞, A _v =0dB, +IN=VDD/2
		Full range	-	-	970		
Maximum output voltage(High) (Note 7)	V _{OH}	25°C	VDD-0.1	-	-	V	R _L =10kΩ
		Full range	VDD-0.1	-	-		
Maximum output voltage(Low) (Note 7)	V _{OL}	25°C	-	-	VSS+0.1	V	R _L =10kΩ
		Full range	-	-	VSS+0.1		
Large signal voltage gain ^(Note 7)	A _v	25°C	80	105	-	dB	VDD=+1.8V
		Full range	80	-	-		
		25°C	80	110	-	dB	VDD=+3.3V
		Full range	80	-	-		
Input common mode voltage	V _{ICM}	25°C	0	-	1.8	V	VDD=+1.8V, VSS to VDD
			0	-	3.3		VDD=+3.3V, VSS to VDD
Common mode rejection ratio ^(Note 7)	CMRR	25°C	70	90	-	dB	-
		Full range	68	-	-		
Power supply rejection ratio ^(Note 7)	PSRR	25°C	70	90	-	dB	-
		Full range	68	-	-		
Output source current ^(Note 8)	I _{source}	25°C	4	6	-	mA	OUT=VDD-0.4V
			-	17	-		output current
Output sink current ^(Note 8)	I _{sink}	25°C	9	15	-	mA	OUT=VSS+0.4V
			-	35	-		output current
Slew rate	SR	25°C	-	2.5	-	V/μs	CL=25pF
Gain bandwidth	GBW	25°C	-	3.0	-	MHz	VDD=+1.8V, f=100kHz, Open loop
			-	3.2	-	MHz	VDD=+3.3V, f=100kHz, Open loop
Phase margin	θ	25°C	-	40	-	deg	Open loop
Input referred noise voltage	V _n	25°C	-	18	-	nV/√Hz	A _v =40dB, f=1kHz
Total harmonics distortion	THD+N	25°C	-	0.005	-	%	OUT=0.4V _{P-P} , f=1kHz

(Note 6) Absolute value

(Note 7) Full range: T_A=-40°C to +85°C

(Note 8) Under the high temperature environment, consider the power dissipation of IC when selecting the output current.

When the terminal short circuits are continuously output, the output current is reduced to climb to the temperature inside IC.

Electrical Characteristics - continued

OBD5291FVE (Unless otherwise specified VDD=+3.3V, VSS=0V, T_A=25°C)

Parameter	Symbol	Temperature Range	Limits			Unit	Condition
			Min	Typ	Max		
Input offset voltage ^(Note 9,10)	V _{IO}	25°C	-	0.1	2.5	mV	VDD=+1.8V, +3.3V
		Full range	-	-	3.8		
Input offset voltage drift ^(Note 9,10)	ΔV _{IO} /ΔT	Full range	-	0.8	-	μV/°C	-
Input offset current ^(Note 9,10)	I _{IO}	25°C	-	1	220	pA	-
		Full range	-	-	1700		
Input bias current ^(Note 9,10)	I _B	25°C	-	1	220	pA	-
		Full range	-	-	2800		
Supply current ^(Note 10)	I _{DD}	25°C	-	650	900	μA	R _L =∞, A _v =0dB, +IN=VDD/2
		Full range	-	-	970		
Maximum output voltage(High) (Note 10)	V _{OH}	25°C	VDD-0.1	-	-	V	R _L =10kΩ
		Full range	VDD-0.1	-	-		
Maximum output voltage(Low) (Note 10)	V _{OL}	25°C	-	-	VSS+0.1	V	R _L =10kΩ
		Full range	-	-	VSS+0.1		
Large signal voltage gain (Note 10)	A _v	25°C	80	105	-	dB	VDD=+1.8V
		Full range	80	-	-		
		25°C	80	110	-	dB	VDD=+3.3V
		Full range	80	-	-		
Input common mode voltage	V _{ICM}	25°C	0	-	1.8	V	VDD=+1.8V, VSS to VDD
			0	-	3.3		VDD=+3.3V, VSS to VDD
Common mode rejection ratio ^(Note 10)	CMRR	25°C	70	90	-	dB	-
		Full range	68	-	-		
Power supply rejection ratio ^(Note 10)	PSRR	25°C	70	90	-	dB	-
		Full range	68	-	-		
Output source current ^(Note 11)	I _{source}	25°C	4	6	-	mA	OUT=VDD-0.4V
			-	17	-		output current
Output sink current ^(Note 11)	I _{sink}	25°C	9	15	-	mA	OUT=VSS+0.4V
			-	35	-		output current
Slew rate	SR	25°C	-	2.5	-	V/μs	CL=25pF
Gain bandwidth	GBW	25°C	-	3.0	-	MHz	VDD=+1.8V, f=100kHz, Open loop
			-	3.2	-	MHz	VDD=+3.3V, f=100kHz, Open loop
Phase margin	θ	25°C	-	40	-	deg	Open loop
Input referred noise voltage	V _n	25°C	-	18	-	nV/√Hz	A _v =40dB, f=1kHz
Total harmonics distortion	THD+N	25°C	-	0.005	-	%	OUT=0.4V _{P-P} , f=1kHz

(Note 9) Absolute value

(Note 10) Full range: T_A=-40°C to +85°C

(Note 11) Under the high temperature environment, consider the power dissipation of IC when selecting the output current.

When the terminal short circuits are continuously output, the output current is reduced to climb to the temperature inside IC.

Description of electrical characteristics

Described here are the terms of electric characteristics used in this datasheet. Items and symbols used are also shown. Note that item name and symbol and their meaning may differ from those on another manufacture's document or general document.

1. Absolute maximum ratings

Absolute maximum rating item indicates the condition which must not be exceeded. Application of voltage in excess of absolute maximum rating or use out of absolute maximum rated temperature environment may cause deterioration of characteristics.

- (1) Power supply voltage (VDD/VSS)
Indicates the maximum voltage that can be applied between the positive power supply terminal and negative power supply terminal without deterioration or destruction of characteristics of internal circuit.
- (2) Differential input voltage (V_{ID})
Indicates the maximum voltage that can be applied between non-inverting terminal and inverting terminal without deterioration and destruction of characteristics of IC.
- (3) Input common-mode voltage range (V_{ICM})
Indicates the maximum voltage that can be applied to non-inverting terminal and inverting terminal without deterioration or destruction of characteristics. Input common-mode voltage range of the maximum ratings not assures normal operation of IC. When normal Operation of IC is desired, the input common-mode voltage of characteristics item must be followed.
- (4) Power dissipation (P_D)
Indicates the power that can be consumed by specified mounted board at the ambient temperature 25°C(normal temperature). As for package product, P_d is determined by the temperature that can be permitted by IC chip in the package (maximum junction temperature) and thermal resistance of the package.

2. Electrical characteristics item

- (1) Input offset voltage (V_{IO})
Indicates the voltage difference between non-inverting terminal and inverting terminal. It can be translated into the input voltage difference required for setting the output voltage at 0 V.
- (2) Input offset voltage drift ($\Delta V_{IO}/\Delta T$)
Denotes the ratio of the input offset voltage fluctuation to the ambient temperature fluctuation.
- (3) Input offset current (I_{IO})
Indicates the difference of input bias current between non-inverting terminal and inverting terminal.
- (4) Input bias current (I_B)
Indicates the current that flows into or out of the input terminal. It is defined by the average of input bias current at non-inverting terminal and input bias current at inverting terminal.
- (5) Supply current (IDD)
Indicates the IC current that flows under specified conditions and no-load steady status.
- (6) Maximum Output Voltage(High) / Maximum Output Voltage(Low) (V_{OH}/V_{OL})
Indicates the voltage range that can be output by the IC under specified load condition. It is typically divided into maximum output voltage High and low. Maximum output voltage high indicates the upper limit of output voltage. Maximum output voltage low indicates the lower limit.
- (7) Large signal voltage gain (A_v)
Indicates the amplifying rate (gain) of output voltage against the voltage difference between non-inverting terminal and inverting terminal. It is normally the amplifying rate (gain) with reference to DC voltage.
 $A_v = (\text{Output voltage}) / (\text{Differential Input voltage})$
- (8) Input common-mode voltage range (V_{ICM})
Indicates the input voltage range where IC operates normally.
- (9) Common-mode rejection ratio (CMRR)
Indicates the ratio of fluctuation of input offset voltage when in-phase input voltage is changed. It is normally the fluctuation of DC.
 $CMRR = (\text{Change of Input common-mode voltage}) / (\text{Input offset voltage fluctuation})$
- (10) Power supply rejection ratio (PSRR)
Indicates the ratio of fluctuation of input offset voltage when supply voltage is changed. It is normally the fluctuation of DC.
 $PSRR = (\text{Change of power supply voltage}) / (\text{Input offset voltage fluctuation})$
- (11) Output source current/ output sink current (I_{SOURCE} / I_{SINK})
The maximum current that can be output under specific output conditions, it is divided into output source current and output sink current. The output source current indicates the current flowing out of the IC, and the output sink current the current flowing into the IC.
- (12) Slew Rate (SR)
SR is a parameter that shows movement speed of operational amplifier. It indicates rate of variable output voltage as unit time.
- (13) Gain Bandwidth (GBW)
Indicates to multiply by the frequency and the gain where the voltage gain decreases 6dB/octave.

Description of electrical characteristics – continued

- (14) Phase Margin (θ)
Indicates the margin of phase from 180 degree phase lag at unity gain frequency.
- (15) Input referred noise voltage (V_n)
Indicates a noise voltage generated inside the operational amplifier equivalent by ideal voltage source connected in series with input terminal.
- (16) Total harmonic distortion + Noise (THD+N)
Indicates the fluctuation of input offset voltage or that of output voltage with reference to the change of output voltage of driven channel.

Typical Performance Curves

OBD5291xxx

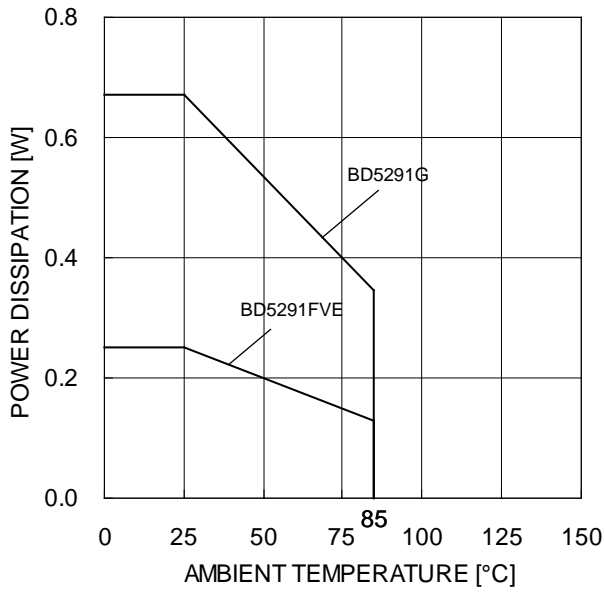

Figure 2. Derating curve

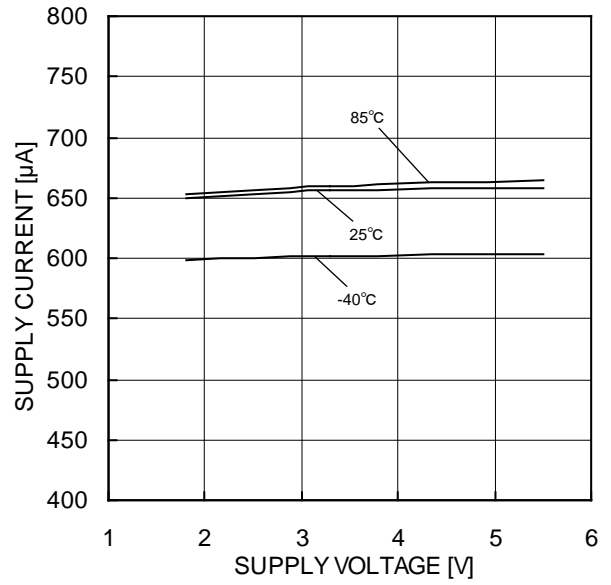

Figure 3. Supply Current – Supply Voltage

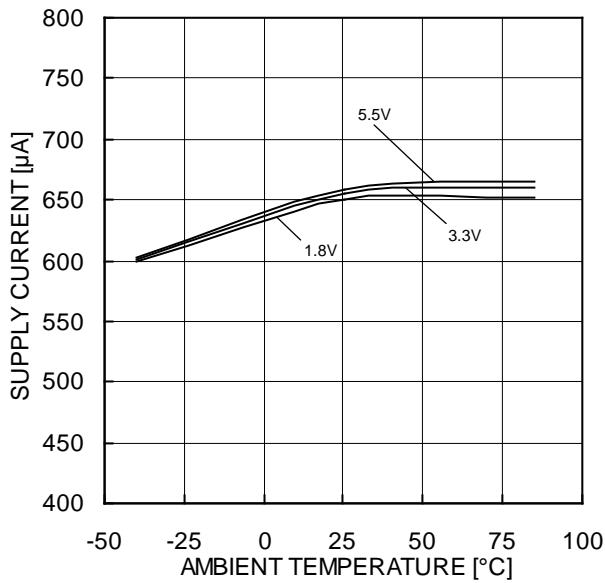

Figure 4. Supply Current – Ambient Temperature

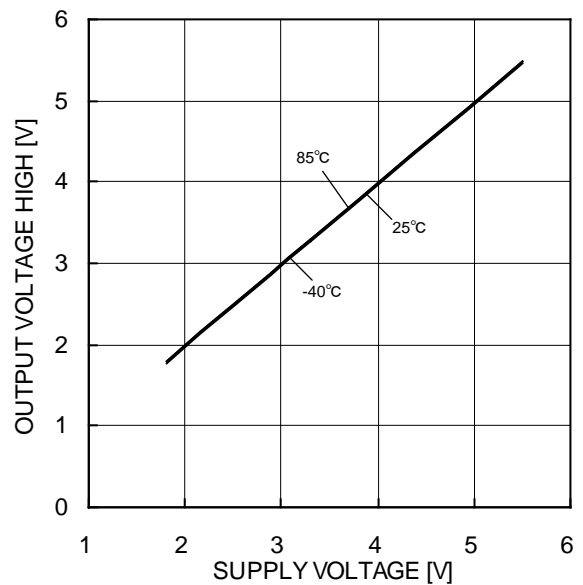

Figure 5. Maximum Output Voltage (High) – Supply Voltage (RL=10kΩ)

(*)The above characteristics are measurements of typical sample, they are not guaranteed.

Typical Performance Curves - continued

OBD5291xxx

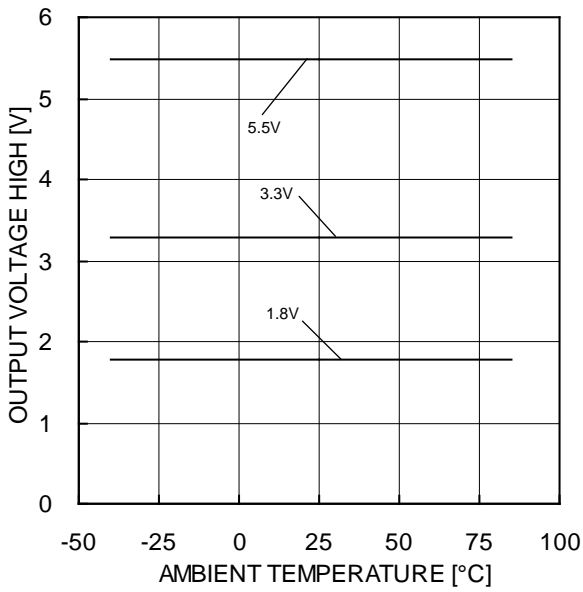

Figure 6.

Maximum Output Voltage (High) – Ambient Temperature (RL=10kΩ)

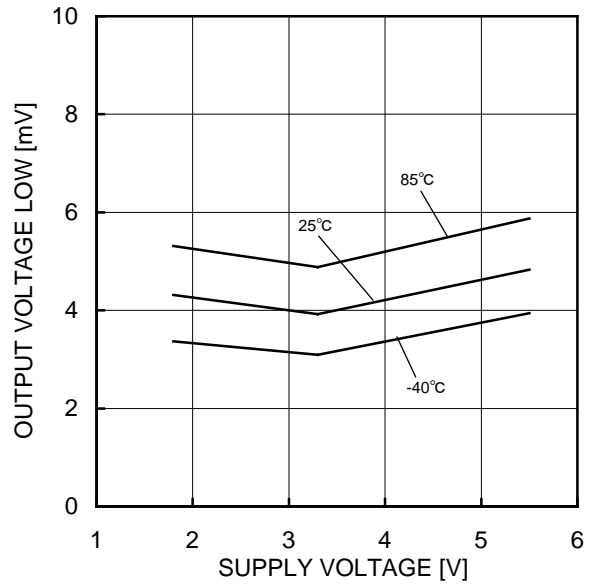

Figure 7.

Maximum Output Voltage (Low) – Supply Voltage (RL=10kΩ)

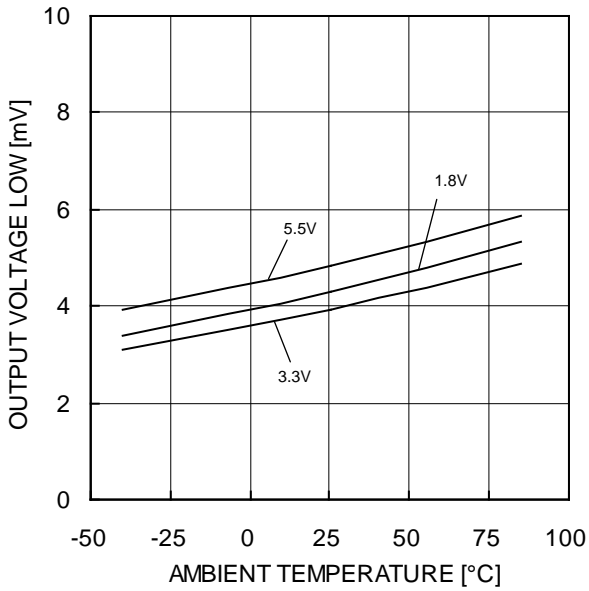

Figure 8.

Maximum Output Voltage (Low) – Ambient Temperature (RL=10kΩ)

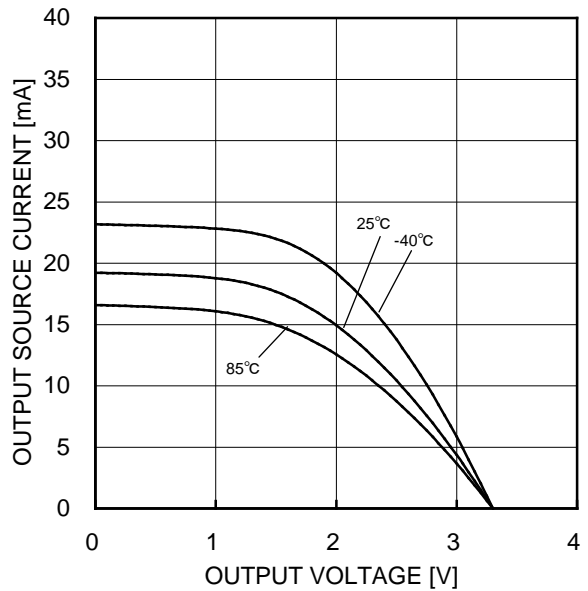

Figure 9.

Output Source Current – Output Voltage (VDD=3.3V)

(*)The above characteristics are measurements of typical sample, they are not guaranteed.

Typical Performance Curves - continued

OBD5291xxx

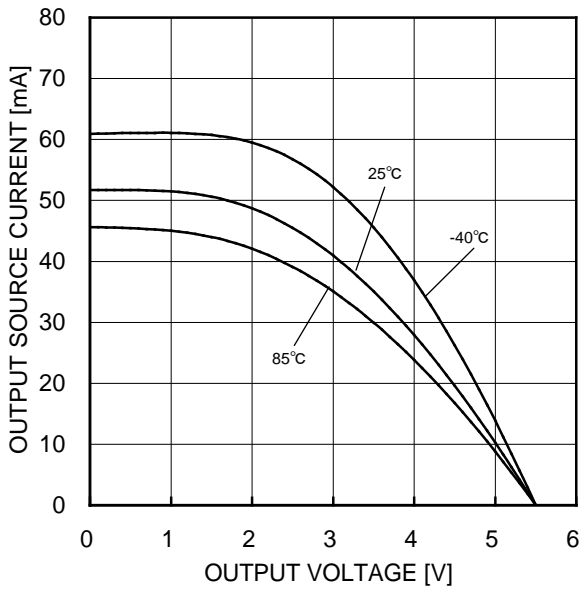

Figure 10.
Output Source Current – Output Voltage
(VDD=5.5V)

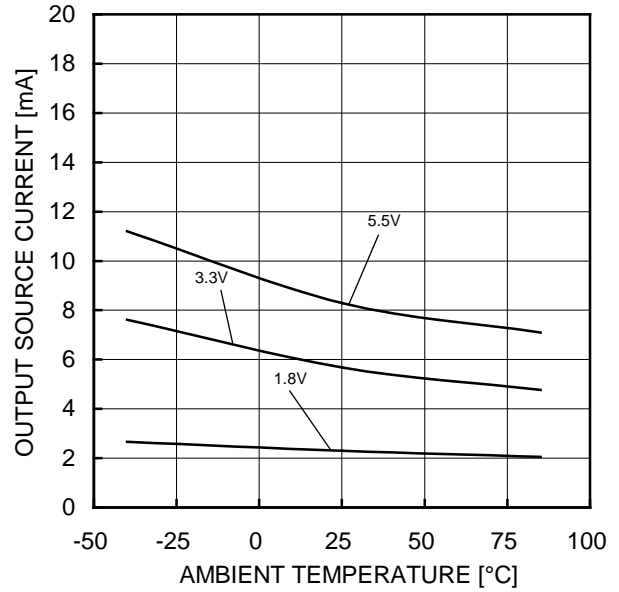

Figure 11.
Output Source Current – Ambient Temperature
(OUT=VDD-0.4V)

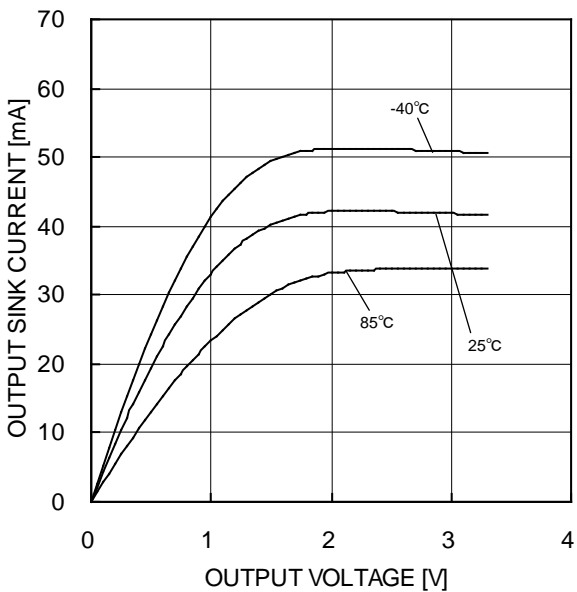

Figure 12.
Output Sink Current – Output Voltage
(VDD=3.3V)

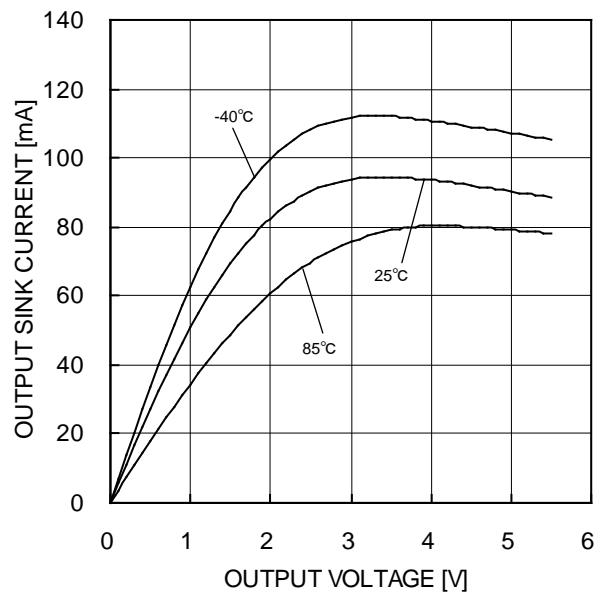

Figure 13.
Output Sink Current – Output Voltage
(VDD=5.5V)

(*)The above characteristics are measurements of typical sample, they are not guaranteed.

Typical Performance Curves - continued

OBD5291xxx

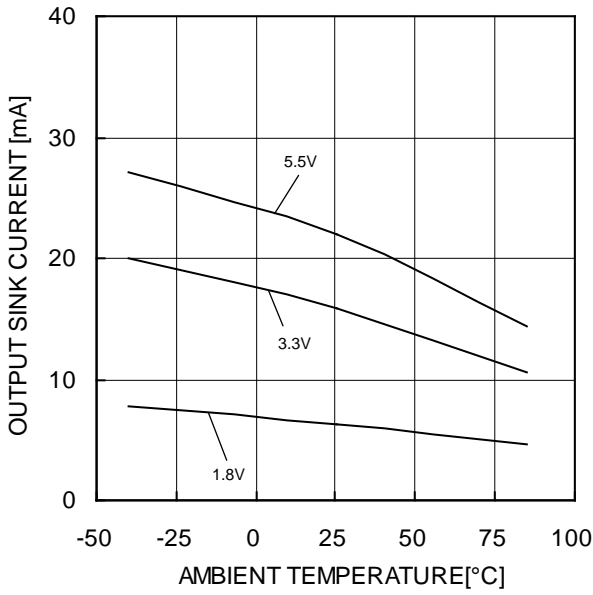

Figure 14.
Output Sink Current – Ambient Temperature
(OUT=VSS+0.4V)

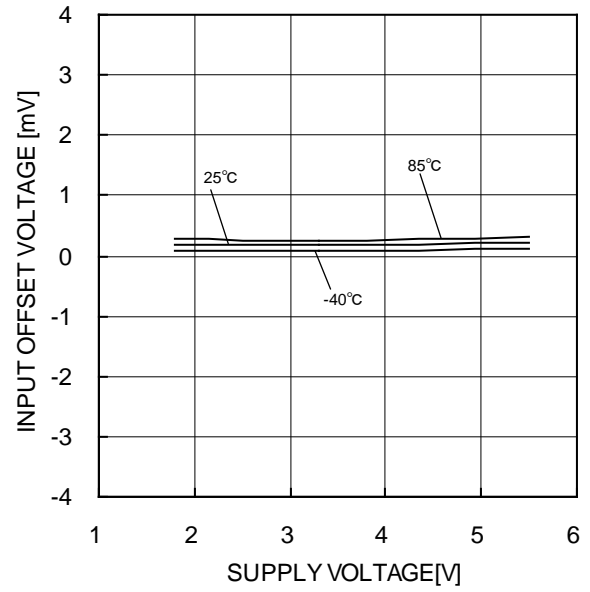

Figure 15.
Input Offset Voltage – Supply Voltage

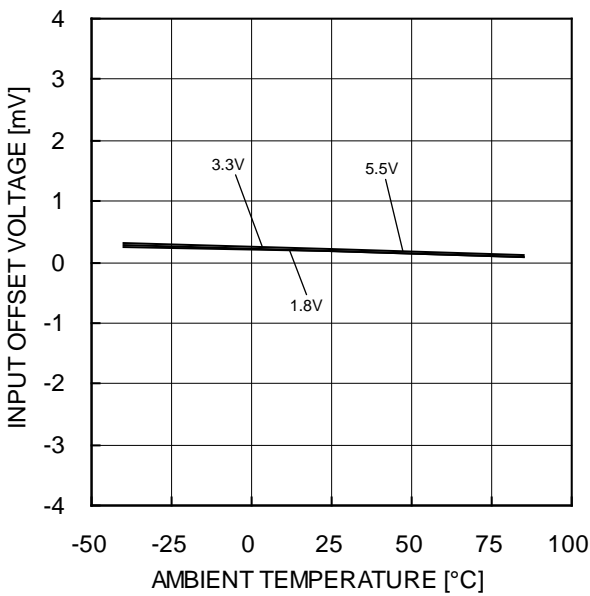

Figure 16.
Input Offset Voltage – Ambient Temperature

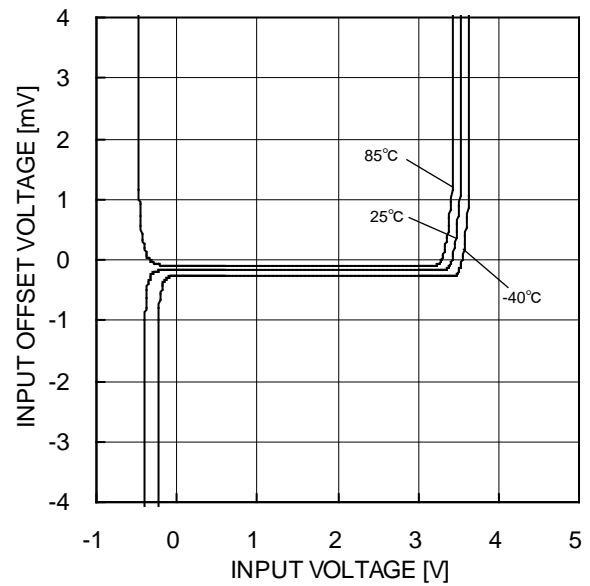

Figure 17.
Input Offset Voltage – Input Voltage
(VDD=3.3V)

(*The above characteristics are measurements of typical sample, they are not guaranteed.

Typical Performance Curves - continued

OBD5291xxx

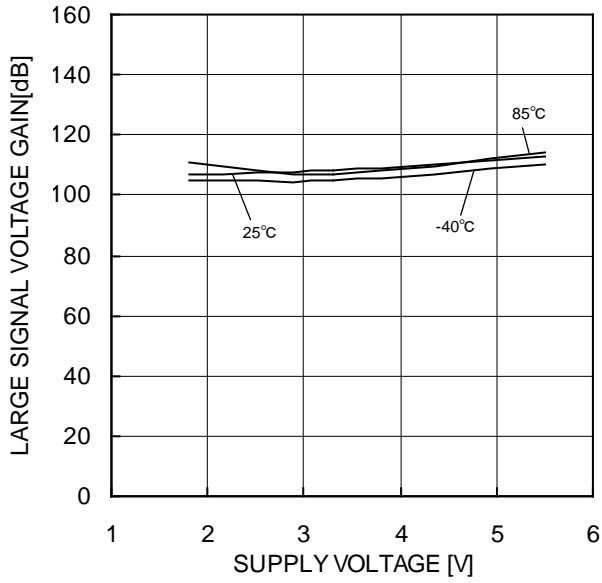

Figure 18.
Large Signal Voltage Gain – Supply Voltage

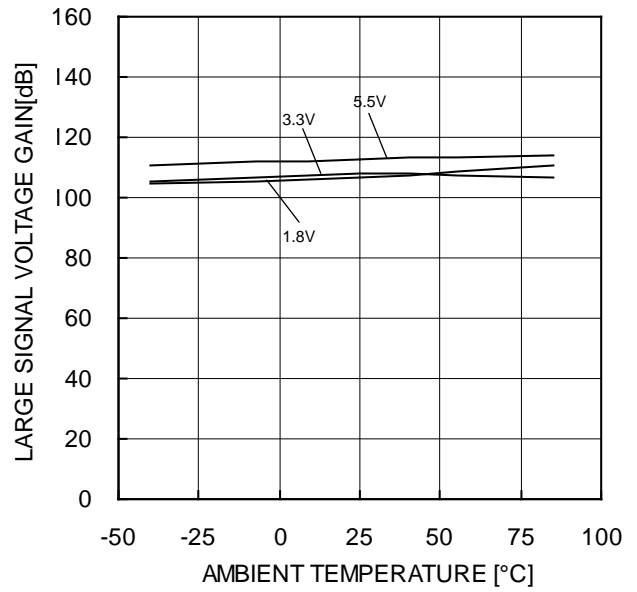

Figure 19.
Large Signal Voltage Gain – Ambient Temperature

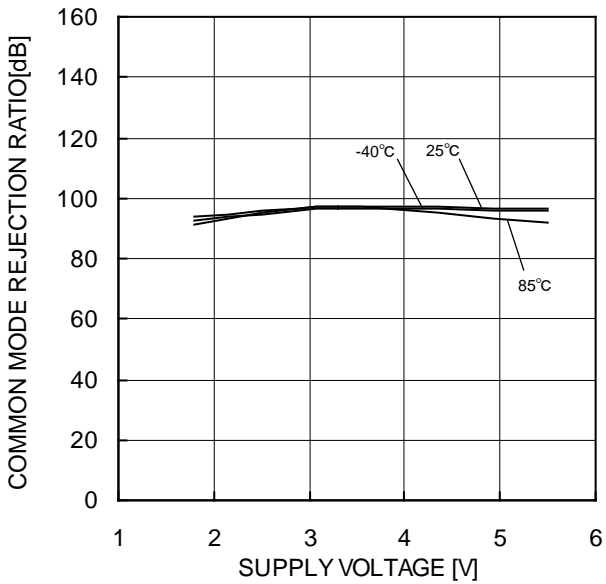

Figure 20.
Common Mode Rejection Ratio – Supply Voltage

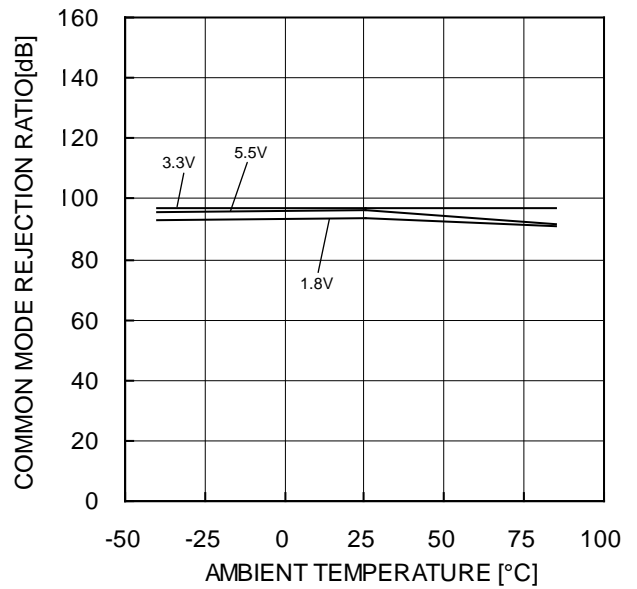

Figure 21.
Common Mode Rejection Ratio – Ambient Temperature

(*The above characteristics are measurements of typical sample, they are not guaranteed.

Typical Performance Curves - continued

OBD5291xxx

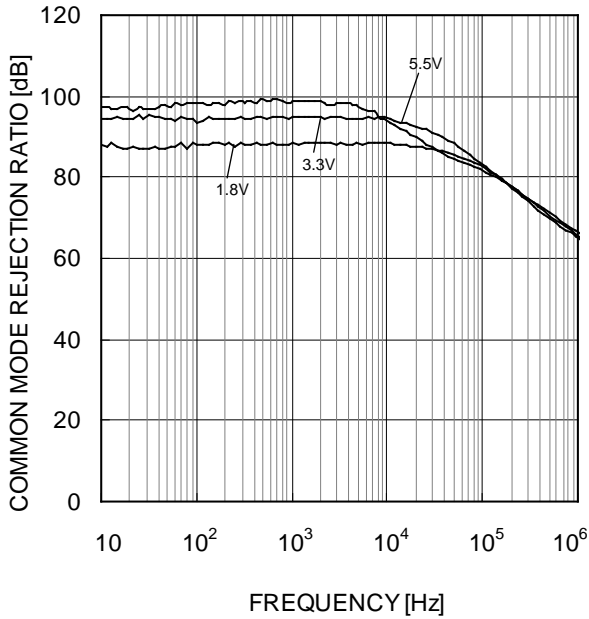

Figure 22.
Common Mode Rejection Ratio – Frequency

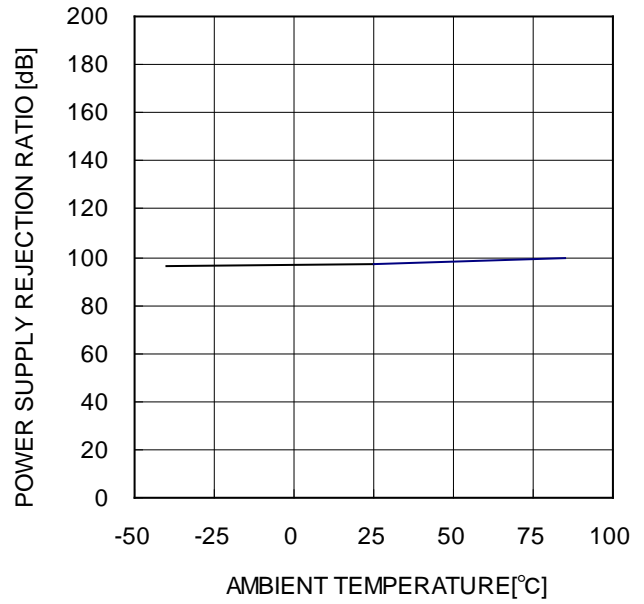

Figure 23.
Power Supply Rejection Ratio – Ambient Temperature
(VDD=1.7V to 5.5V)

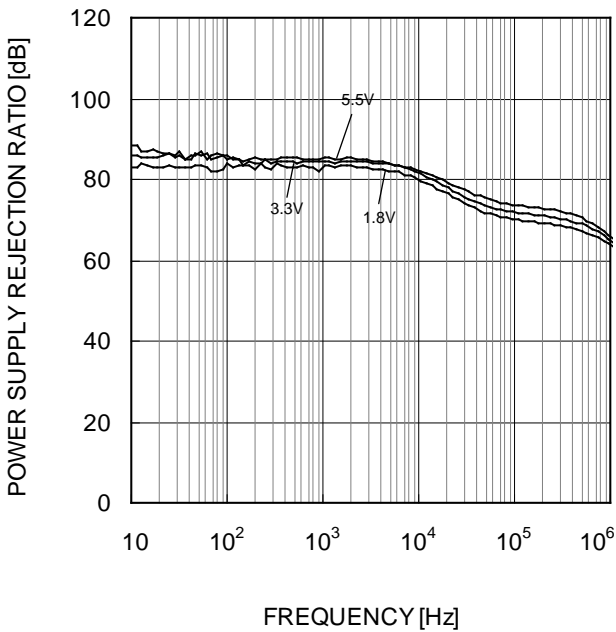

Figure 24.
Power Supply Rejection Ratio – Frequency

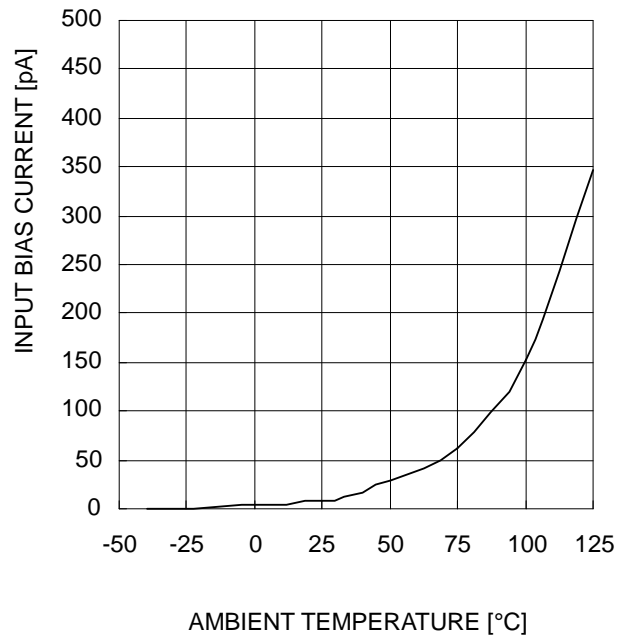

Figure 25.
Input Bias Current – Ambient Temperature
(VDD=3.3V)

(*)The above characteristics are measurements of typical sample, they are not guaranteed.

Typical Performance Curves – continued

OBD5291xxx

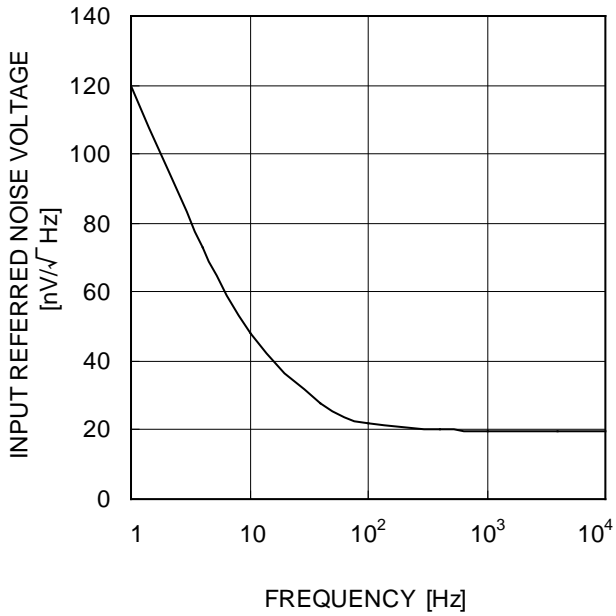

Figure 26.
Input Referred Noise Voltage – Frequency
(VDD=3.3V)

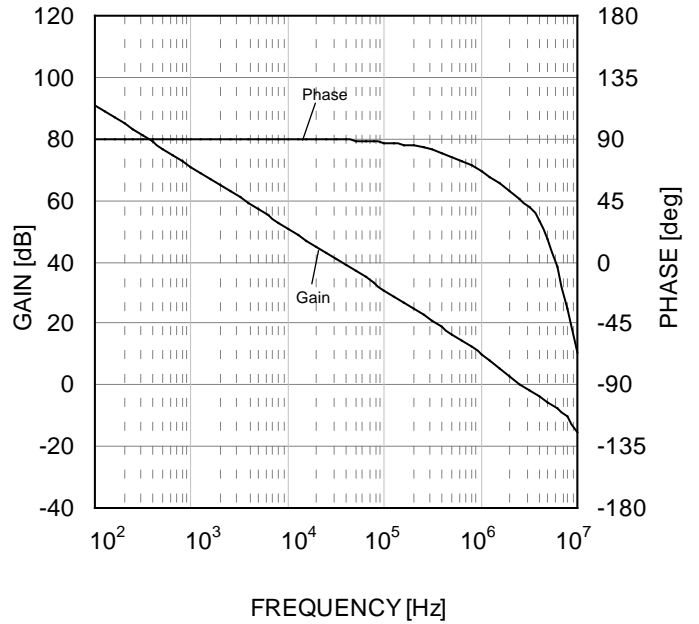

Figure 27.
Voltage Gain, Phase – Frequency
(VDD=3.3V , Open loop)

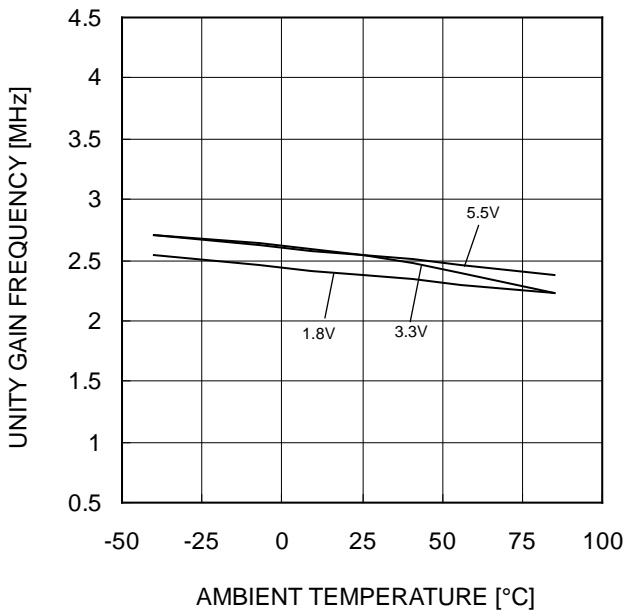

Figure 28.
Unity Gain Frequency – Ambient Temperature

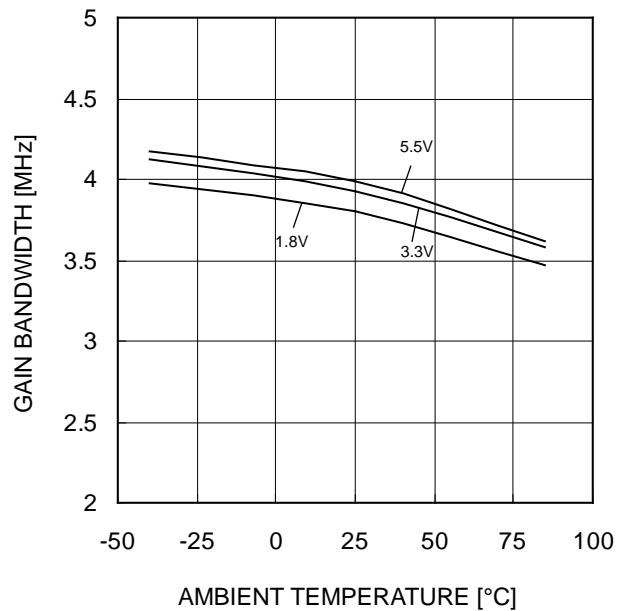

Figure 29.
Gain Bandwidth – Ambient Temperature

(*)The above characteristics are measurements of typical sample, they are not guaranteed.

Typical Performance Curves – continued

OBD5291xxx

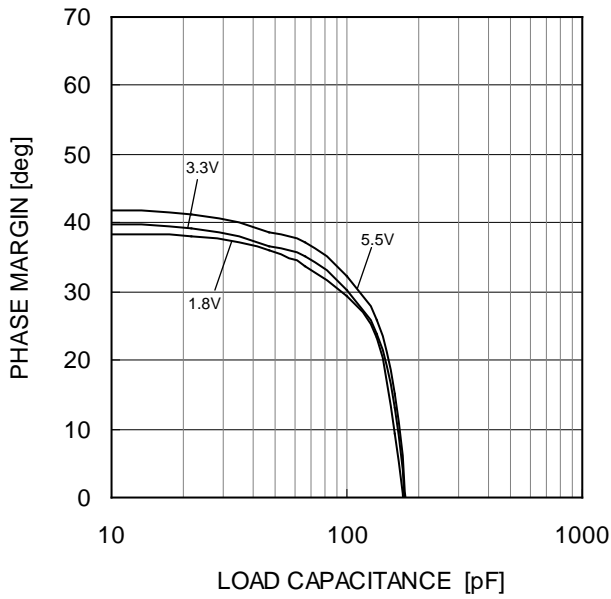

Figure 30.
Phase Margin—Load Capacitance

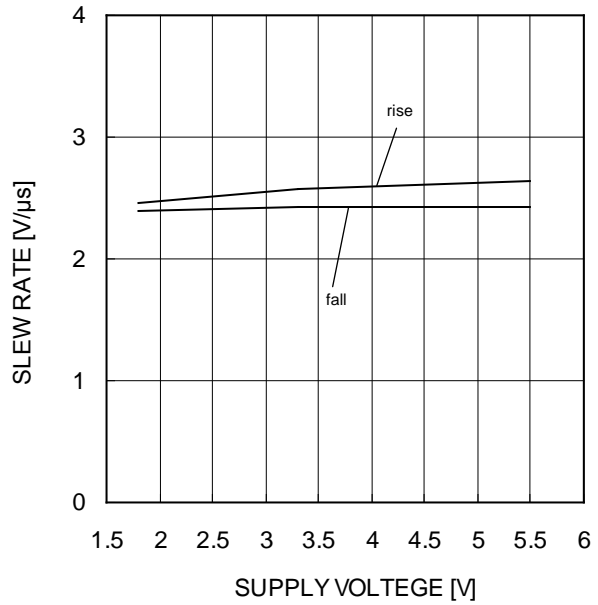

Figure 31.
Slew Rate—Supply Voltage

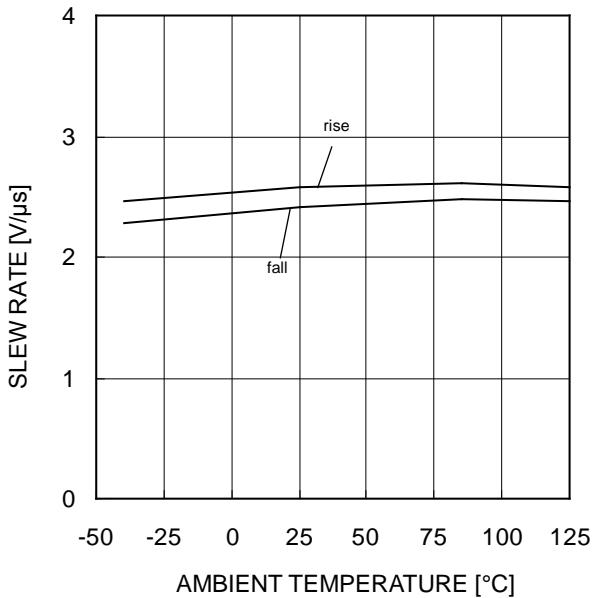

Figure 32.
Slew Rate – Ambient Temperature
(VDD=3.3V)

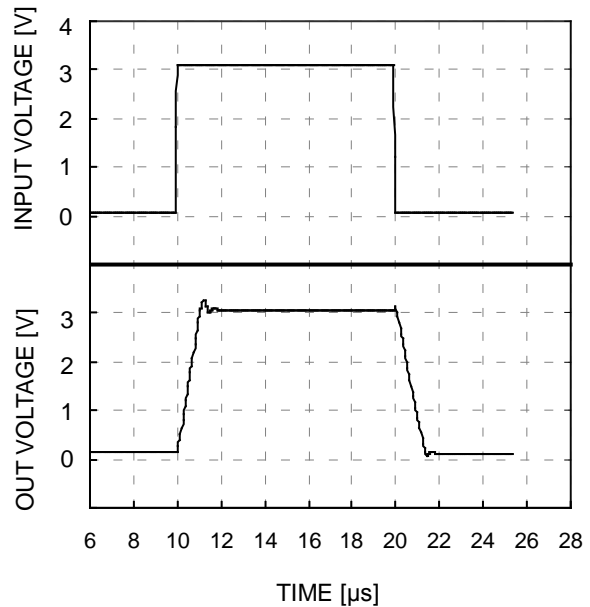

Figure 33.
Input and Output Wave Form
(VDD=5V, A_v=1, R_L=2kΩ, C_L=10pF
IN=3V_{P-P}, T_A=25°C)

(*)The above characteristics are measurements of typical sample, they are not guaranteed.

Typical Performance Curves - continued

OBD5291xxx

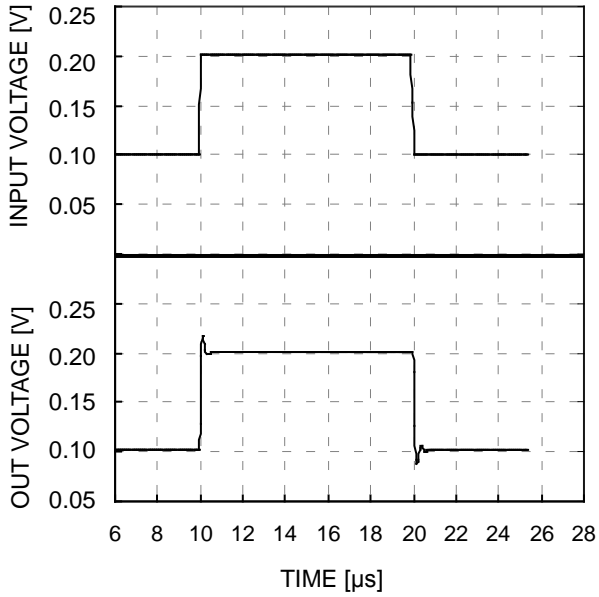

Figure 34.
Input and Output Wave Form
(VDD=5V, $A_V=1$, $R_L=2k\Omega$, $C_L=10pF$
 $I_N=100mV_{P-P}$, $T_A=25^\circ C$)

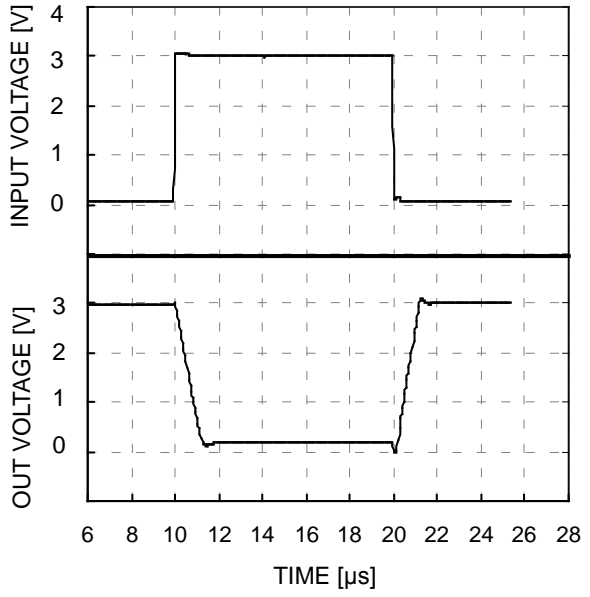

Figure 35.
Input and Output Wave Form
(VDD=5V, $A_V=-1$, $R_L=2k\Omega$, $C_L=10pF$
 $I_N=3V_{P-P}$, $T_A=25^\circ C$)

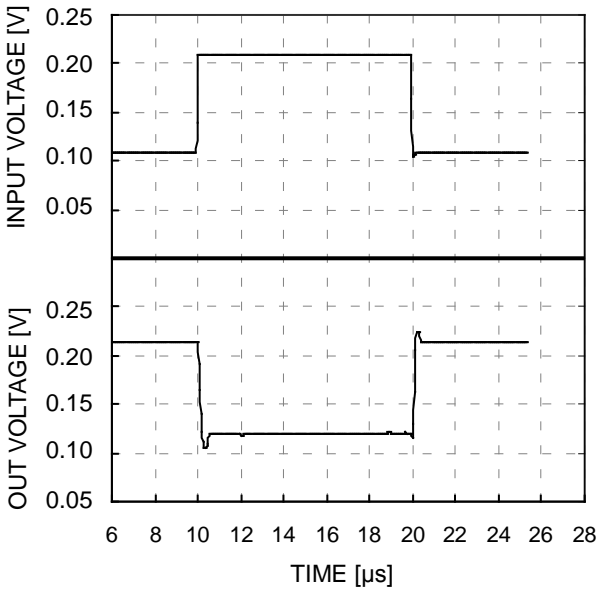

Figure 36.
Input and Output Wave Form
(VDD=5V, $A_V=-1$, $R_L=2k\Omega$, $C_L=10pF$
 $I_N=100mV_{P-P}$, $T_A=25^\circ C$)

(*)The above characteristics are measurements of typical sample, they are not guaranteed.

Application Information
NULL method condition for Test Circuit 1

VDD, VSS, EK, VICM Unit:V

Parameter	V _F	SW1	SW2	SW3	VDD	VSS	E _K	V _{ICM}	V _{RL}	Calculation
Input Offset Voltage	V _{F1}	ON	ON	OFF	3.3	0	-1.65	1.65	-	1
Large Signal Voltage Gain	V _{F2}	ON	ON	ON	3.3	0	-0.5	0.9	1.65	2
	V _{F3}						-2.5		1.65	
Common-mode Rejection Ratio (Input Common-mode Voltage Range)	V _{F4}	ON	ON	OFF	3.3	0	-1.5	0	-	3
	V _{F5}						-1.5	3.3	-	
Power Supply Rejection Ratio	V _{F6}	ON	ON	OFF	1.7	0	-0.9	0	-	4
	V _{F7}				5.5				-	

— Calculation—

1. Input Offset Voltage (V_{IO})
$$V_{IO} = \frac{|V_{F1}|}{1+R_F/R_S} [V]$$

2. Large Signal Voltage Gain (A_v)
$$A_v = 20\text{Log} \frac{\Delta V_{EK} \times (1+R_F/R_S)}{|V_{F2}-V_{F3}|} [dB]$$

3. Common-mode Rejection Ratio (CMRR)
$$\text{CMRR} = 20\text{Log} \frac{\Delta V_{ICM} \times (1+R_F/R_S)}{|V_{F4} - V_{F5}|} [dB]$$

4. Power Supply Rejection Ratio (PSRR)
$$\text{PSRR} = 20\text{Log} \frac{\Delta V_{DD} \times (1+ R_F/R_S)}{|V_{F6} - V_{F7}|} [dB]$$

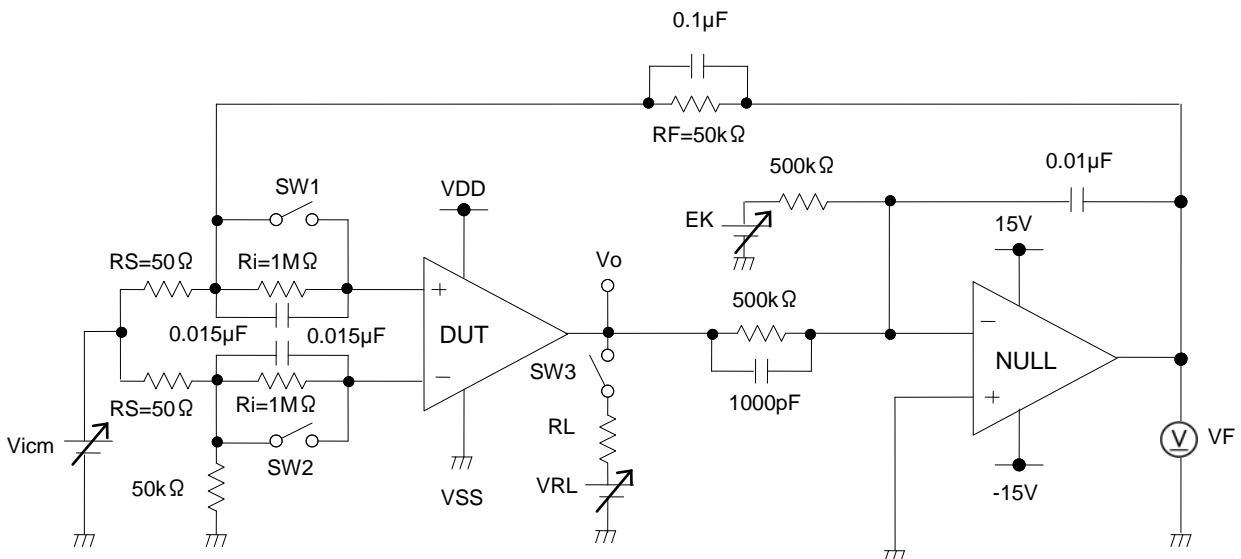

Figure 37. Test circuit 1

Application Information - continued
Switch Condition for Test Circuit 2

Parameter	SW1	SW2	SW3	SW4	SW5	SW6	SW7	SW8	SW9	SW10	SW11	SW12
Supply Current	OFF	OFF	ON	OFF	ON	OFF	OFF	OFF	OFF	OFF	OFF	OFF
Maximum Output Voltage $R_L=10k\Omega$	OFF	ON	OFF	OFF	ON	OFF	OFF	ON	OFF	OFF	ON	OFF
Output Current	OFF	ON	OFF	OFF	ON	OFF	OFF	OFF	OFF	ON	OFF	OFF
Slew Rate	OFF	OFF	ON	OFF	OFF	OFF	ON	OFF	ON	OFF	OFF	ON
Unit gain frequency	ON	OFF	OFF	ON	ON	OFF	OFF	OFF	ON	OFF	OFF	ON

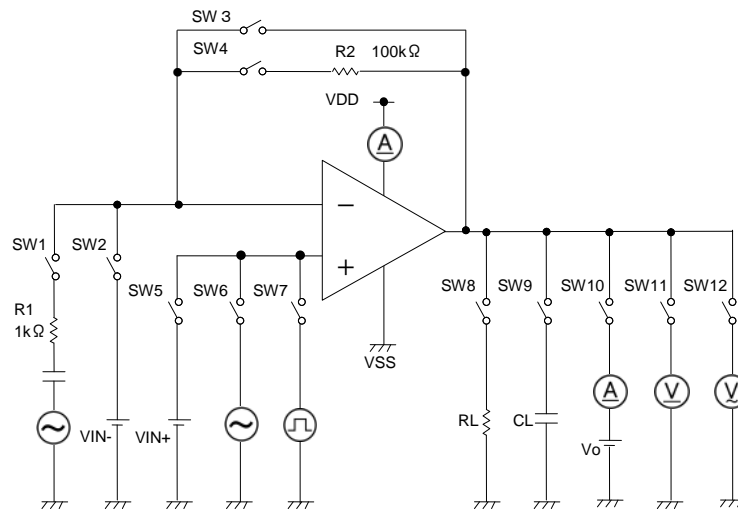

Figure 38. Test circuit 2

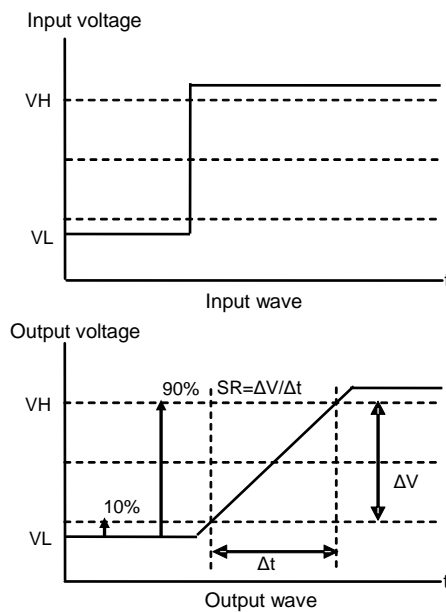

Figure 39. Slew rate input output wave

Application example

○Voltage follower

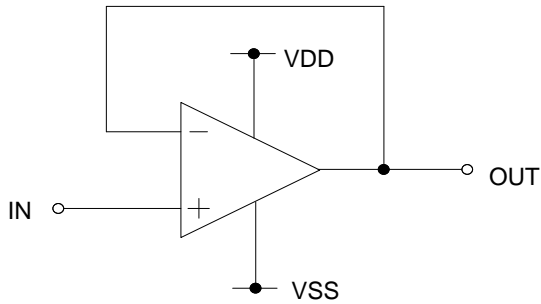

Figure 40. Voltage follower

Voltage gain is 0dB.

Using this circuit, the output voltage (OUT) is configured to be equal to the input voltage (IN). This circuit also stabilizes the output voltage (OUT) due to high input impedance and low output impedance. Expression for output voltage (OUT) is shown below.

$$OUT=IN$$

○Inverting amplifier

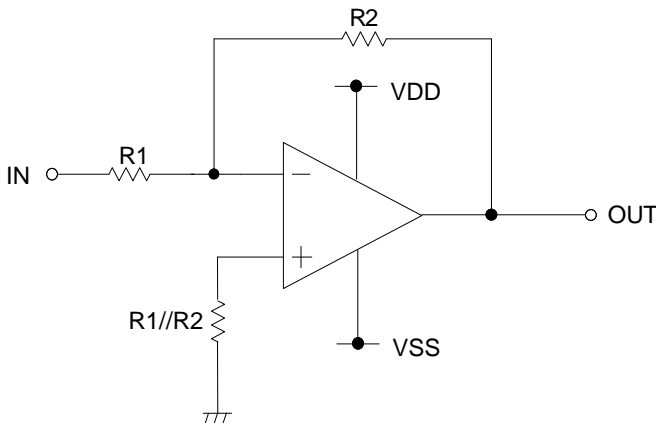

Figure 41. Inverting amplifier circuit

For inverting amplifier, input voltage (IN) is amplified by a voltage gain and depends on the ratio of R1 and R2. The out-of-phase output voltage is shown in the next expression

$$OUT=-\left(\frac{R2}{R1}\right) \cdot IN$$

This circuit has input impedance equal to R1.

○Non-inverting amplifier

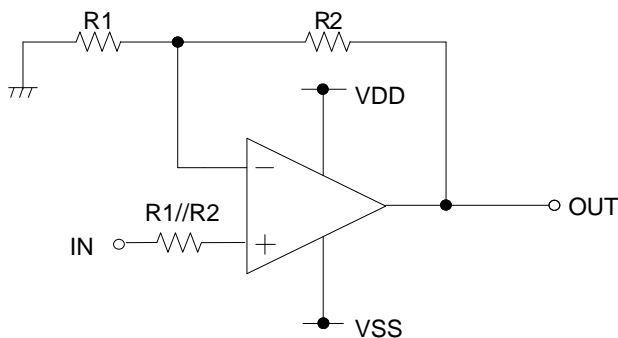

Figure 42. Non-inverting amplifier circuit

For non-inverting amplifier, input voltage (IN) is amplified by a voltage gain, which depends on the ratio of R1 and R2. The output voltage (OUT) is in-phase with the input voltage (IN) and is shown in the next expression.

$$OUT=\left(1 + \frac{R2}{R1}\right) \cdot IN$$

Effectively, this circuit has high input impedance since its input side is the same as that of the operational amplifier.

Power Dissipation

Power dissipation (total loss) indicates the power that can be consumed by IC at $T_A=25^{\circ}\text{C}$ (normal temperature). IC is heated when it consumed power, and the temperature of IC chip becomes higher than ambient temperature. The temperature that can be accepted by IC chip depends on circuit configuration, manufacturing process, and consumable power is limited. Power dissipation is determined by the temperature allowed in IC chip (maximum junction temperature) and thermal resistance of package (heat dissipation capability). The maximum junction temperature is typically equal to the maximum value in the storage package (heat dissipation capability). The maximum junction temperature is typically equal to the maximum value in the storage temperature range. Heat generated by consumed power of IC radiates from the mold resin or lead frame of the package. The parameter which indicates this heat dissipation capability (hardness of heat release) is called thermal resistance, represented by the symbol $\theta_{JA}^{\circ}\text{C/W}$. The temperature of IC inside the package can be estimated by this thermal resistance.

Figure 43.(a) shows the model of thermal resistance of the package. Thermal resistance θ_{JA} , ambient temperature T_A , maximum junction temperature T_{jmax} , and power dissipation P_D can be calculated by the equation below:

$$\theta_{JA} = (T_{jmax} - T_A) / P_D \quad ^{\circ}\text{C/W}$$

Derating curve in Figure 43.(b) indicates power that can be consumed by IC with reference to ambient temperature. Power that can be consumed by IC begins to attenuate at certain ambient temperature. This gradient is determined by thermal resistance θ_{JA} . Thermal resistance θ_{JA} depends on chip size, power consumption, package, ambient temperature, package condition, wind velocity, etc even when the same of package is used. Thermal reduction curve indicates a reference value measured at a specified condition. Figure 43.(c),(d) show a derating curve for an example of BD5291xxx.

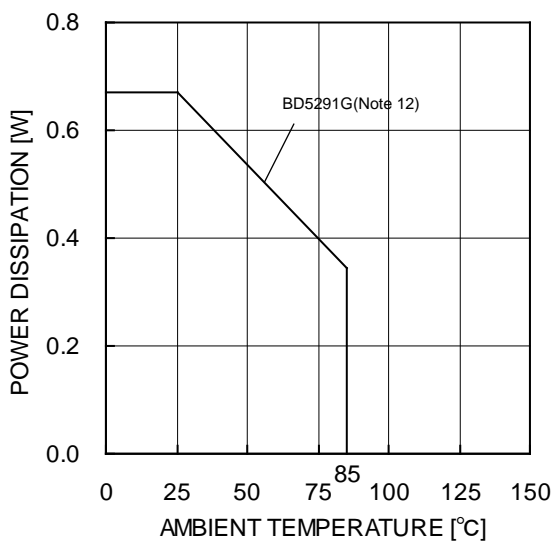
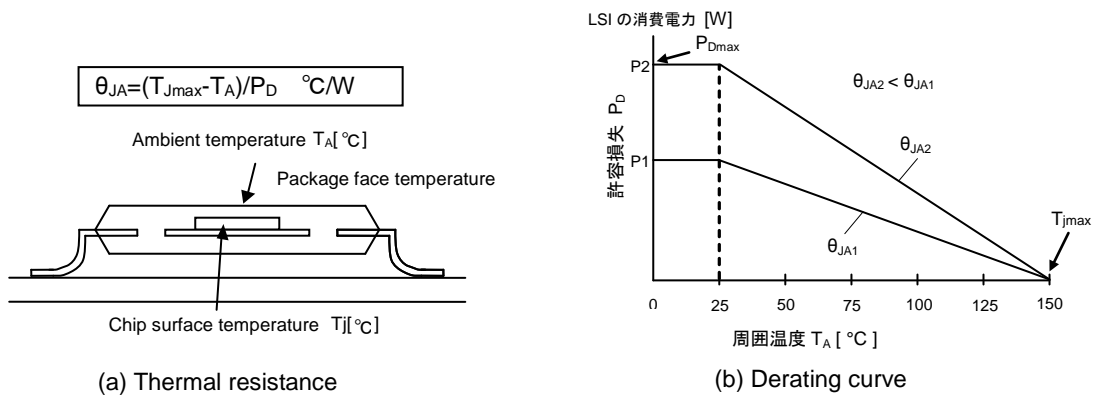

(c) BD5291G

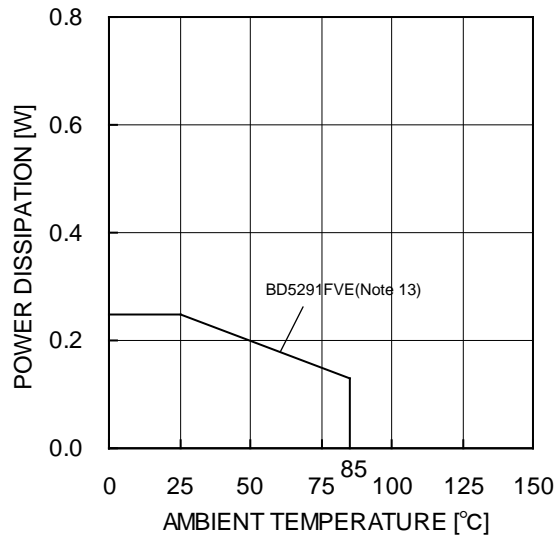

(d) BD5291FVE

Note 12	Note 13	Unit
5.4	2.0	mW/°C

When using the unit above $T_A=25^{\circ}\text{C}$, subtract the value above per $^{\circ}\text{C}$. Permissible dissipation is the value when FR4 glass epoxy board 70mm x 70mm x 1.6mm (copper foil area below 3%) is mounted

Figure 43. Derating Curve

Operational Notes

- 1. Reverse Connection of Power Supply**

Connecting the power supply in reverse polarity can damage the IC. Take precautions against reverse polarity when connecting the power supply, such as mounting an external diode between the power supply and the IC's power supply pins.
- 2. Power Supply Lines**

Design the PCB layout pattern to provide low impedance supply lines. Separate the ground and supply lines of the digital and analog blocks to prevent noise in the ground and supply lines of the digital block from affecting the analog block. Furthermore, connect a capacitor to ground at all power supply pins. Consider the effect of temperature and aging on the capacitance value when using electrolytic capacitors.
- 3. Ground Voltage**

Ensure that no pins are at a voltage below that of the ground pin at any time, even during transient condition. However, pins that drive inductive loads (e.g. motor driver outputs, DC-DC converter outputs) may inevitably go below ground due to back EMF or electromotive force. In such cases, the user should make sure that such voltages going below ground will not cause the IC and the system to malfunction by examining carefully all relevant factors and conditions such as motor characteristics, supply voltage, operating frequency and PCB wiring to name a few.
- 4. Ground Wiring Pattern**

When using both small-signal and large-current ground traces, the two ground traces should be routed separately but connected to a single ground at the reference point of the application board to avoid fluctuations in the small-signal ground caused by large currents. Also ensure that the ground traces of external components do not cause variations on the ground voltage. The ground lines must be as short and thick as possible to reduce line impedance.
- 5. Thermal Consideration**

Should by any chance the power dissipation rating be exceeded the rise in temperature of the chip may result in deterioration of the properties of the chip. The absolute maximum rating of the Pd stated in this specification is when the IC is mounted on a 70mm x 70mm x 1.6mm glass epoxy board. In case of exceeding this absolute maximum rating, increase the board size and copper area to prevent exceeding the Pd rating.
- 6. Recommended Operating Conditions**

These conditions represent a range within which the expected characteristics of the IC can be approximately obtained. The electrical characteristics are guaranteed under the conditions of each parameter.
- 7. Inrush Current**

When power is first supplied to the IC, it is possible that the internal logic may be unstable and inrush current may flow instantaneously due to the internal powering sequence and delays, especially if the IC has more than one power supply. Therefore, give special consideration to power coupling capacitance, power wiring, width of ground wiring, and routing of connections.
- 8. Operation Under Strong Electromagnetic Field**

Operating the IC in the presence of a strong electromagnetic field may cause the IC to malfunction.
- 9. Testing on Application Boards**

When testing the IC on an application board, connecting a capacitor directly to a low-impedance output pin may subject the IC to stress. Always discharge capacitors completely after each process or step. The IC's power supply should always be turned off completely before connecting or removing it from the test setup during the inspection process. To prevent damage from static discharge, ground the IC during assembly and use similar precautions during transport and storage.
- 10. Inter-pin Short and Mounting Errors**

Ensure that the direction and position are correct when mounting the IC on the PCB. Incorrect mounting may result in damaging the IC. Avoid nearby pins being shorted to each other especially to ground, power supply and output pin. Inter-pin shorts could be due to many reasons such as metal particles, water droplets (in very humid environment) and unintentional solder bridge deposited in between pins during assembly to name a few.
- 11. Unused Input Pins**

Input pins of an IC are often connected to the gate of a MOS transistor. The gate has extremely high impedance and extremely low capacitance. If left unconnected, the electric field from the outside can easily charge it. The small charge acquired in this way is enough to produce a significant effect on the conduction through the transistor and cause unexpected operation of the IC. So unless otherwise specified, unused input pins should be connected to the power supply or ground line.

Operational Notes – continued

12. Regarding the Input Pin of the IC

This monolithic IC contains P+ isolation and P substrate layers between adjacent elements in order to keep them isolated. P-N junctions are formed at the intersection of the P layers with the N layers of other elements, creating a parasitic diode or transistor. For example (refer to figure below):

When $GND > Pin\ A$ and $GND > Pin\ B$, the P-N junction operates as a parasitic diode.

When $GND > Pin\ B$, the P-N junction operates as a parasitic transistor.

Parasitic diodes inevitably occur in the structure of the IC. The operation of parasitic diodes can result in mutual interference among circuits, operational faults, or physical damage. Therefore, conditions that cause these diodes to operate, such as applying a voltage lower than the GND voltage to an input pin (and thus to the P substrate) should be avoided.

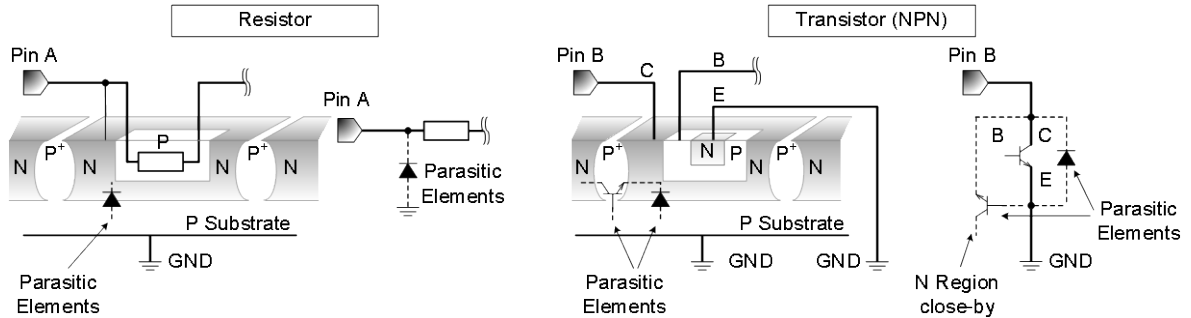

Figure 44. Example of monolithic IC structure

13. Oscillation for feed back circuit

Be careful when using the IC in feed back circuit. Phase margin of this IC is 40°. Oscillation is caused by large size capacitive load connecting to output terminal. If the circuit has large size capacitor that is connected to output terminal. Please insert of isolation resistor between output terminal and capacitive load.

14. Input Voltage

Applying $VDD+0.3V$ to the input terminal is possible without causing deterioration of the electrical characteristics or destruction, regardless of the supply voltage. However, this does not ensure normal circuit operation. Please note that the circuit operates normally only when the input voltage is within the common mode input voltage range of the electric characteristics.

15. Power supply(single/dual)

The operational amplifiers operate when the voltage supplied is between VDD and VSS. Therefore, the single supply operational amplifiers can be used as dual supply operational amplifiers as well.

16. Output capacitor

Discharge of the external output capacitor to VDD is possible via internal parasitic elements when VDD is shorted to VSS, causing damage to the internal circuitry due to thermal stress. Therefore, when using this IC in circuits where oscillation due to output capacitive load does not occur, such as in voltage comparators, use an output capacitor with a capacitance less than 0.1 μF .

Designed negative feedback circuit using this IC, verify output oscillation caused by capacitive load.

17. Latch up

Be careful of input voltage that exceed the VDD and VSS. When CMOS device have sometimes occur latch up operation. And protect the IC from abnormally noise.

18. Decoupling Capacitor

Insert the decoupling capacitance between VDD and VSS, for stable operation of operational amplifier.

Marking Diagram

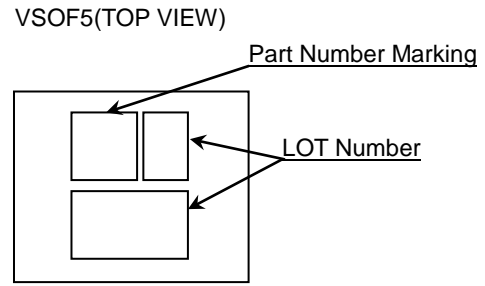
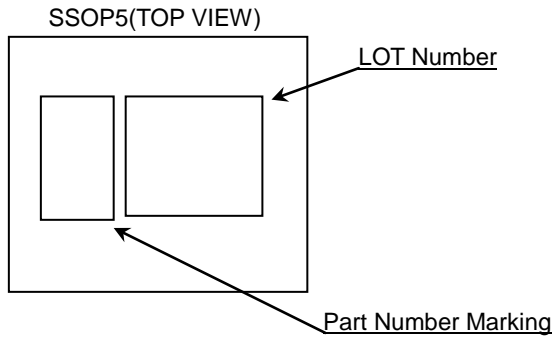

Product Name		Package Type	Marking
BD5291	G	SSOP5	L7
	FVE	VSOF5	N6

Land Pattern data

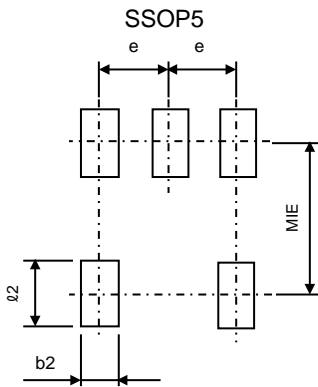

Unit : mm

PKG	Land Pitch e	Land Space MIE	Land Length $\geq \phi 2$	Land Width b2
SSOP5	0.95	2.4	1.0	0.6
VSOF5	0.5	1.35	0.35	0.25

Physical Dimensions Tape and Reel Information

Package Name	SSOP5
--------------	-------

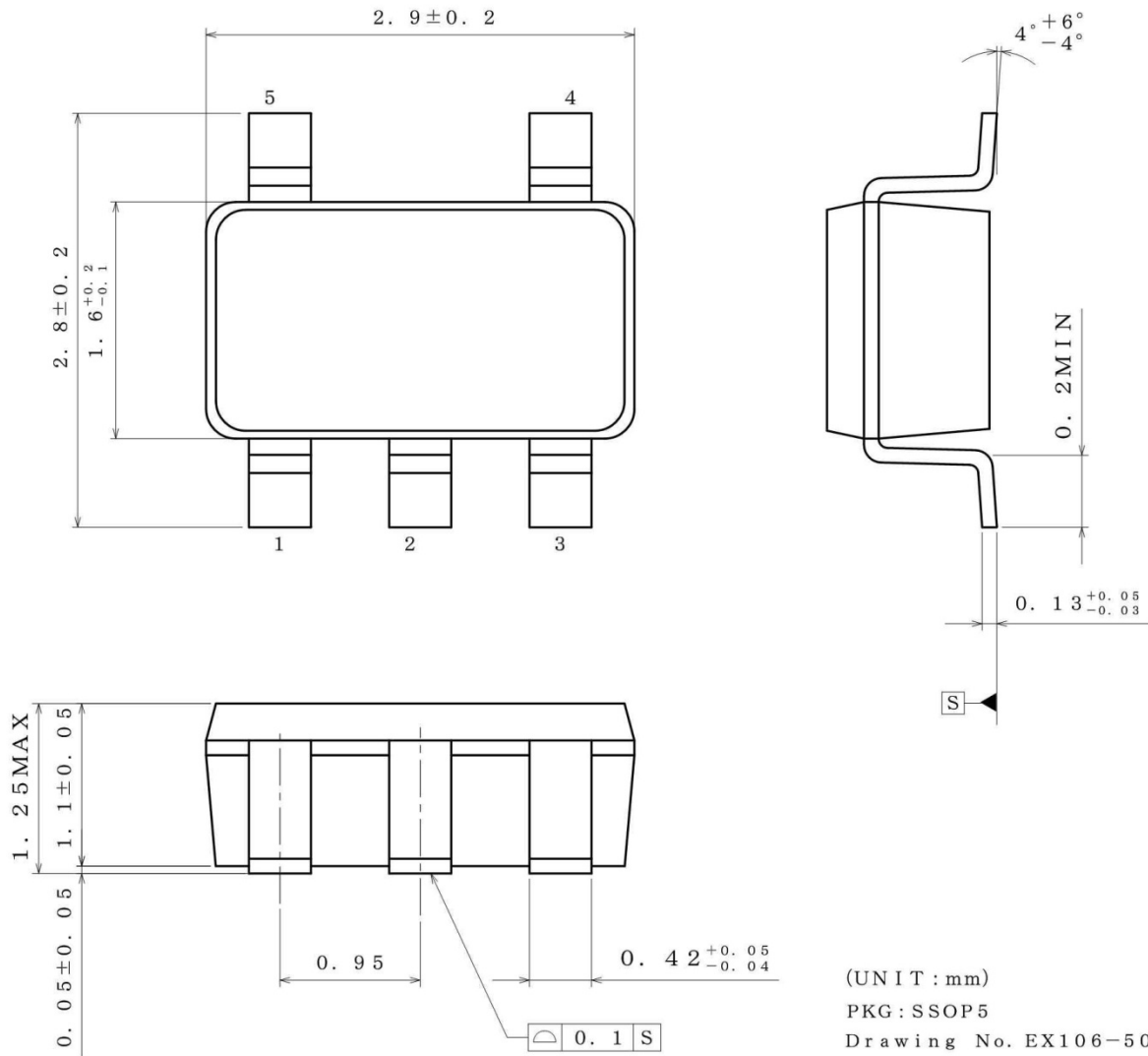

< Tape and Reel Information >

Tape	Embossed carrier tape
Quantity	3000pcs
Direction of feed	TL [The direction is the 1pin of product is at the lower left when you hold reel on the left hand and you pull out the tape on the right hand]

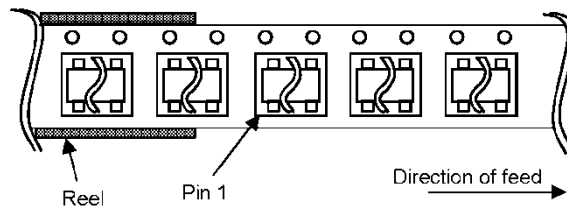

Physical Dimensions Tape and Reel Information – continued

Package Name	VSO5F5
--------------	--------

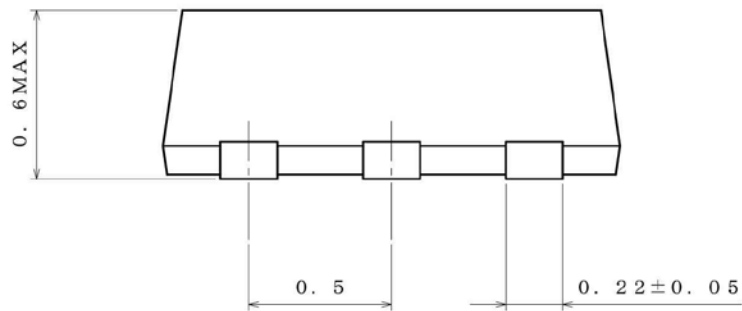
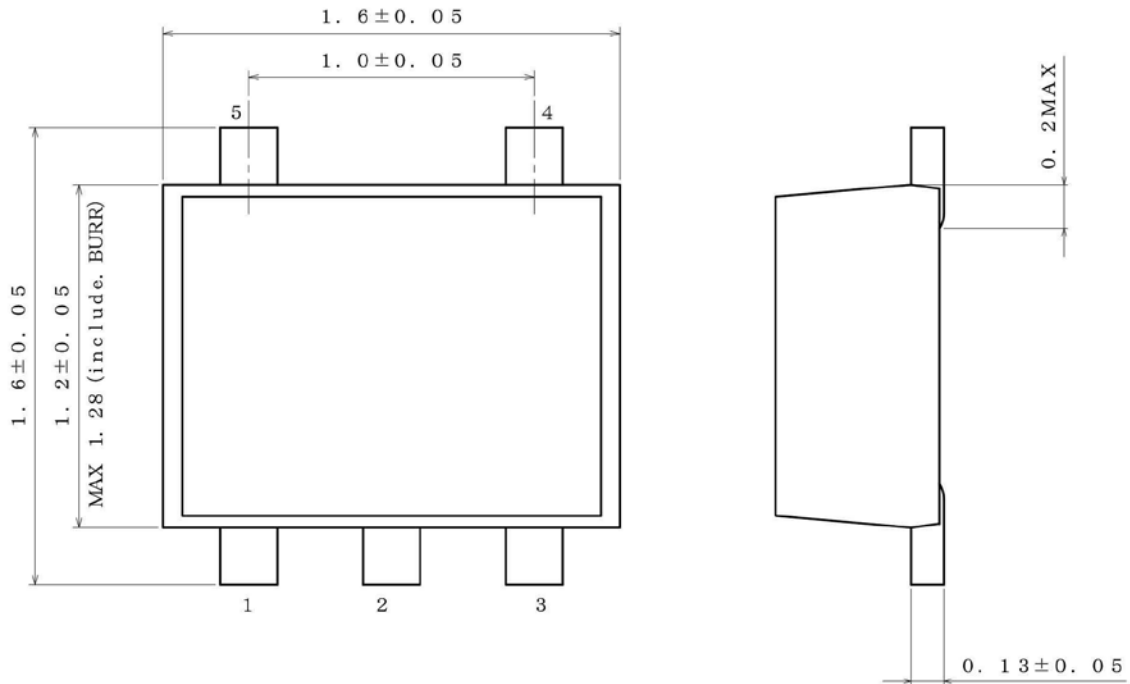

(UNIT : mm)
 PKG : VSO5F5
 Drawing No. EX107-5002

<包装仕様>

包装形態	エンボステーピング
包装数量	3000pcs
包装方向	TR (リールを左手に持ち、右手でテープを引き出したときに) (製品の1番ピンが右上にくる方向)

※ご発注の際は、包装数量の倍数でお願い致します。

Revision History

Date	Revision	Changes
10.JUN.2013	001	New Release
26.NOV.2013	002	Add BD5291FVE, Delete Simplified Schematic
13.FEB.2014	003	General Description is modified
22.APR.2014	004	Delete BD5291FVE
06.Jun.2016	005	Added BD5291FVE

Notice

Precaution on using ROHM Products

- Our Products are designed and manufactured for application in ordinary electronic equipments (such as AV equipment, OA equipment, telecommunication equipment, home electronic appliances, amusement equipment, etc.). If you intend to use our Products in devices requiring extremely high reliability (such as medical equipment ^(Note 1), transport equipment, traffic equipment, aircraft/spacecraft, nuclear power controllers, fuel controllers, car equipment including car accessories, safety devices, etc.) and whose malfunction or failure may cause loss of human life, bodily injury or serious damage to property ("Specific Applications"), please consult with the ROHM sales representative in advance. Unless otherwise agreed in writing by ROHM in advance, ROHM shall not be in any way responsible or liable for any damages, expenses or losses incurred by you or third parties arising from the use of any ROHM's Products for Specific Applications.

(Note1) Medical Equipment Classification of the Specific Applications

JAPAN	USA	EU	CHINA
CLASS III	CLASS III	CLASS II b	CLASS III
CLASS IV		CLASS III	

- ROHM designs and manufactures its Products subject to strict quality control system. However, semiconductor products can fail or malfunction at a certain rate. Please be sure to implement, at your own responsibilities, adequate safety measures including but not limited to fail-safe design against the physical injury, damage to any property, which a failure or malfunction of our Products may cause. The following are examples of safety measures:
 - Installation of protection circuits or other protective devices to improve system safety
 - Installation of redundant circuits to reduce the impact of single or multiple circuit failure
- Our Products are designed and manufactured for use under standard conditions and not under any special or extraordinary environments or conditions, as exemplified below. Accordingly, ROHM shall not be in any way responsible or liable for any damages, expenses or losses arising from the use of any ROHM's Products under any special or extraordinary environments or conditions. If you intend to use our Products under any special or extraordinary environments or conditions (as exemplified below), your independent verification and confirmation of product performance, reliability, etc. prior to use, must be necessary:
 - Use of our Products in any types of liquid, including water, oils, chemicals, and organic solvents
 - Use of our Products outdoors or in places where the Products are exposed to direct sunlight or dust
 - Use of our Products in places where the Products are exposed to sea wind or corrosive gases, including Cl₂, H₂S, NH₃, SO₂, and NO₂
 - Use of our Products in places where the Products are exposed to static electricity or electromagnetic waves
 - Use of our Products in proximity to heat-producing components, plastic cords, or other flammable items
 - Sealing or coating our Products with resin or other coating materials
 - Use of our Products without cleaning residue of flux (even if you use no-clean type fluxes, cleaning residue of flux is recommended); or Washing our Products by using water or water-soluble cleaning agents for cleaning residue after soldering
 - Use of the Products in places subject to dew condensation
- The Products are not subject to radiation-proof design.
- Please verify and confirm characteristics of the final or mounted products in using the Products.
- In particular, if a transient load (a large amount of load applied in a short period of time, such as pulse. is applied, confirmation of performance characteristics after on-board mounting is strongly recommended. Avoid applying power exceeding normal rated power; exceeding the power rating under steady-state loading condition may negatively affect product performance and reliability.
- De-rate Power Dissipation depending on ambient temperature. When used in sealed area, confirm that it is the use in the range that does not exceed the maximum junction temperature.
- Confirm that operation temperature is within the specified range described in the product specification.
- ROHM shall not be in any way responsible or liable for failure induced under deviant condition from what is defined in this document.

Precaution for Mounting / Circuit board design

- When a highly active halogenous (chlorine, bromine, etc.) flux is used, the residue of flux may negatively affect product performance and reliability.
- In principle, the reflow soldering method must be used on a surface-mount products, the flow soldering method must be used on a through hole mount products. If the flow soldering method is preferred on a surface-mount products, please consult with the ROHM representative in advance.

For details, please refer to ROHM Mounting specification

Precautions Regarding Application Examples and External Circuits

1. If change is made to the constant of an external circuit, please allow a sufficient margin considering variations of the characteristics of the Products and external components, including transient characteristics, as well as static characteristics.
2. You agree that application notes, reference designs, and associated data and information contained in this document are presented only as guidance for Products use. Therefore, in case you use such information, you are solely responsible for it and you must exercise your own independent verification and judgment in the use of such information contained in this document. ROHM shall not be in any way responsible or liable for any damages, expenses or losses incurred by you or third parties arising from the use of such information.

Precaution for Electrostatic

This Product is electrostatic sensitive product, which may be damaged due to electrostatic discharge. Please take proper caution in your manufacturing process and storage so that voltage exceeding the Products maximum rating will not be applied to Products. Please take special care under dry condition (e.g. Grounding of human body / equipment / solder iron, isolation from charged objects, setting of Ionizer, friction prevention and temperature / humidity control).

Precaution for Storage / Transportation

1. Product performance and soldered connections may deteriorate if the Products are stored in the places where:
 - [a] the Products are exposed to sea winds or corrosive gases, including Cl₂, H₂S, NH₃, SO₂, and NO₂
 - [b] the temperature or humidity exceeds those recommended by ROHM
 - [c] the Products are exposed to direct sunshine or condensation
 - [d] the Products are exposed to high Electrostatic
2. Even under ROHM recommended storage condition, solderability of products out of recommended storage time period may be degraded. It is strongly recommended to confirm solderability before using Products of which storage time is exceeding the recommended storage time period.
3. Store / transport cartons in the correct direction, which is indicated on a carton with a symbol. Otherwise bent leads may occur due to excessive stress applied when dropping of a carton.
4. Use Products within the specified time after opening a humidity barrier bag. Baking is required before using Products of which storage time is exceeding the recommended storage time period.

Precaution for Product Label

A two-dimensional barcode printed on ROHM Products label is for ROHM's internal use only.

Precaution for Disposition

When disposing Products please dispose them properly using an authorized industry waste company.

Precaution for Foreign Exchange and Foreign Trade act

Since concerned goods might be fallen under listed items of export control prescribed by Foreign exchange and Foreign trade act, please consult with ROHM in case of export.

Precaution Regarding Intellectual Property Rights

1. All information and data including but not limited to application example contained in this document is for reference only. ROHM does not warrant that foregoing information or data will not infringe any intellectual property rights or any other rights of any third party regarding such information or data.
2. ROHM shall not have any obligations where the claims, actions or demands arising from the combination of the Products with other articles such as components, circuits, systems or external equipment (including software).
3. No license, expressly or implied, is granted hereby under any intellectual property rights or other rights of ROHM or any third parties with respect to the Products or the information contained in this document. Provided, however, that ROHM will not assert its intellectual property rights or other rights against you or your customers to the extent necessary to manufacture or sell products containing the Products, subject to the terms and conditions herein.

Other Precaution



1. This document may not be reprinted or reproduced, in whole or in part, without prior written consent of ROHM.
2. The Products may not be disassembled, converted, modified, reproduced or otherwise changed without prior written consent of ROHM.
3. In no event shall you use in any way whatsoever the Products and the related technical information contained in the Products or this document for any military purposes, including but not limited to, the development of mass-destruction weapons.
4. The proper names of companies or products described in this document are trademarks or registered trademarks of ROHM, its affiliated companies or third parties.

General Precaution





1. Before you use our Products, you are requested to carefully read this document and fully understand its contents. ROHM shall not be in any way responsible or liable for failure, malfunction or accident arising from the use of any ROHM's Products against warning, caution or note contained in this document.
2. All information contained in this document is current as of the issuing date and subject to change without any prior notice. Before purchasing or using ROHM's Products, please confirm the latest information with a ROHM sales representative.
3. The information contained in this document is provided on an "as is" basis and ROHM does not warrant that all information contained in this document is accurate and/or error-free. ROHM shall not be in any way responsible or liable for any damages, expenses or losses incurred by you or third parties resulting from inaccuracy or errors of or concerning such information.

Looking for pricing, stock, or lifecycle information?

Click below to explore more details on WIN SOURCE:

-  [View BD5291G-GTL on WIN SOURCE](#)
-  [Rohm Semiconductor](#) Information

Optimize Your Supply Chain with WIN SOURCE Solutions

-  Global Sourcing Solution
-  Obsolete Management
-  Cost Control Management
-  Shortage Management
-  Alternative Solution
-  Excess Inventory Management