



**THE DATASHEET OF
MMSZ4690-TP**



Features

- V_Z – Tolerance $\pm 5\%$
- High Reliability
- Halogen Free. "Green" Device (Note 1)
- Moisture Sensitivity Level 1
- Epoxy Meets UL 94 V-0 Flammability Rating
- Lead Free Finish/RoHS Compliant ("P" Suffix Designates RoHS Compliant. See Ordering Information)

**500 mW
Zener Diode
1.8 to 39 Volts**

Maximum Ratings

- Operating Junction Temperature Range: -55°C to $+150^{\circ}\text{C}$
- Storage Temperature Range: -55°C to $+150^{\circ}\text{C}$
- Thermal Resistance : 340°C/W Junction to Ambient

Parameter	Symbol	Rating	Conditions
Steady State Power Dissipation	P_D	500mW	$T_L < 75^{\circ}\text{C}$
Maximum Forward Voltage	V_F	0.95V	$I_F = 10\text{mA}$

Note: 1. Halogen free "Green" products are defined as those which contain <900ppm bromine, <900ppm chlorine (<1500ppm total Br + Cl) and <1000ppm antimony compounds.

SOD-123

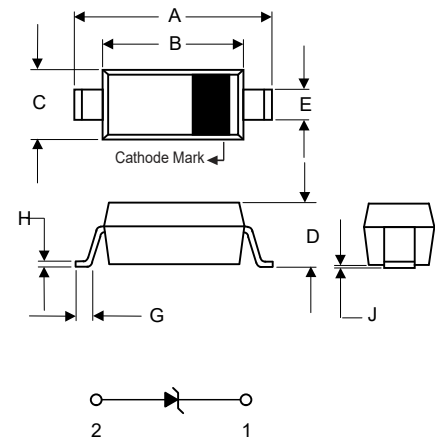

DIM	INCHES		MM		NOTE
	MIN	MAX	MIN	MAX	
A	0.140	0.152	3.55	3.85	
B	0.100	0.112	2.55	2.85	
C	0.055	0.071	1.40	1.80	
D	----	0.053	----	1.35	
E	0.018	0.026	0.45	0.65	
G	0.006	----	0.15	----	
H	----	0.010	----	0.25	
J	----	0.006	----	0.15	

SUGGESTED SOLDER PAD LAYOUT

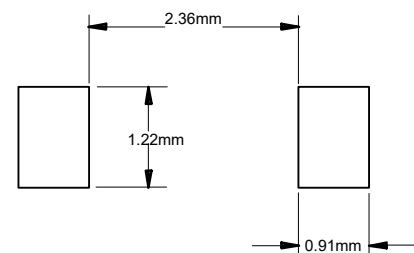

Electrical Characteristics @ 25°C Unless Otherwise Specified

MCC Part Number	Zener Voltage				Leakage Current $I_R @ V_R$		Marking Code
	$V_Z @ I_{ZT}$			I_{ZT}	I_R	V_R	
	Min.(V)	Nom(V)	Max.(V)	μA	μA	V	
MMSZ4678	1.71	1.8	1.89	50	7.5	1.0	CC
MMSZ4679	1.90	2.0	2.10	50	5.0	1.0	CD
MMSZ4680	2.09	2.2	2.31	50	4.0	1.0	CE
MMSZ4681	2.28	2.40	2.52	50	2.0	1.0	CF
MMSZ4682	2.565	2.7	2.835	50	1.0	1.0	CH
MMSZ4683	2.85	3.0	3.15	50	0.8	1.0	CJ
MMSZ4684	3.135	3.3	3.465	50	7.5	1.5	CK
MMSZ4685	3.42	3.6	3.78	50	7.5	2.0	CM
MMSZ4686	3.705	3.9	4.095	50	5.0	2.0	CN
MMSZ4687	4.085	4.3	4.515	50	4.0	2.0	CP
MMSZ4688	4.465	4.7	4.935	50	10	3.0	CT
MMSZ4689	4.845	5.1	5.355	50	10	3.0	CU
MMSZ4690	5.32	5.6	5.88	50	10	4.0	CV
MMSZ4691	5.89	6.2	6.51	50	10	5.0	CA
MMSZ4692	6.46	6.8	7.14	50	10	5.1	CX
MMSZ4693	7.125	7.5	7.875	50	10	5.7	CY
MMSZ4694	7.79	8.2	8.61	50	1	6.2	CZ
MMSZ4695	8.265	8.7	9.135	50	1	6.6	DC
MMSZ4696	8.645	9.1	9.555	50	1	6.9	DD
MMSZ4697	9.50	10	10.5	50	1	7.6	DE
MMSZ4698	10.45	11	11.55	50	0.05	8.4	DF
MMSZ4699	11.40	12	12.6	50	0.05	9.1	DH
MMSZ4700	12.35	13	13.65	50	0.05	9.8	DJ
MMSZ4701	13.30	14	14.7	50	0.05	10.6	DK
MMSZ4702	14.25	15	15.75	50	0.05	11.4	DM
MMSZ4703	15.20	16	16.8	50	0.05	12.1	DN
MMSZ4704	16.15	17	17.85	50	0.05	12.9	DP
MMSZ4705	17.10	18	18.9	50	0.05	13.6	DT
MMSZ4706	18.05	19	19.95	50	0.05	14.4	DU
MMSZ4707	19.00	20	21	50	0.01	15.2	DV
MMSZ4708	20.9	22	23.1	50	0.01	16.7	DA
MMSZ4709	22.8	24	25.2	50	0.01	18.2	DX
MMSZ4710	23.75	25	26.25	50	0.01	19.0	DY
MMSZ4711	25.65	27	28.35	50	0.01	20.4	EA
MMSZ4712	26.6	28	29.4	50	0.01	21.2	EC
MMSZ4713	28.5	30	31.5	50	0.01	22.8	ED
MMSZ4714	31.35	33	34.65	50	0.01	25.0	EE
MMSZ4715	34.2	36	37.8	50	0.01	27.3	EF
MMSZ4716	37.05	39	40.95	50	0.01	29.6	EH

Curve Characteristics

Fig. 1 - Steady State Power Derating

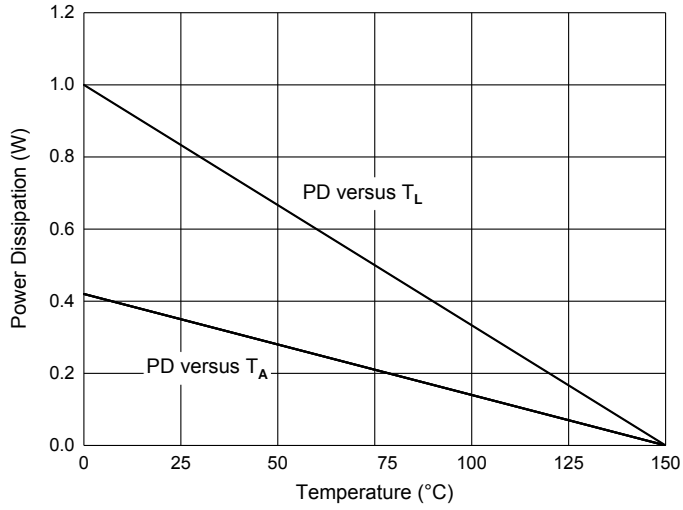

Fig. 2 - Typical Zener Breakdown Characteristics

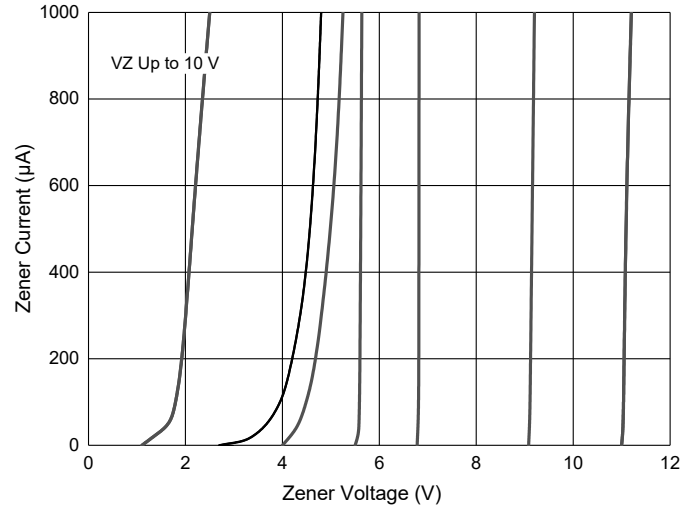
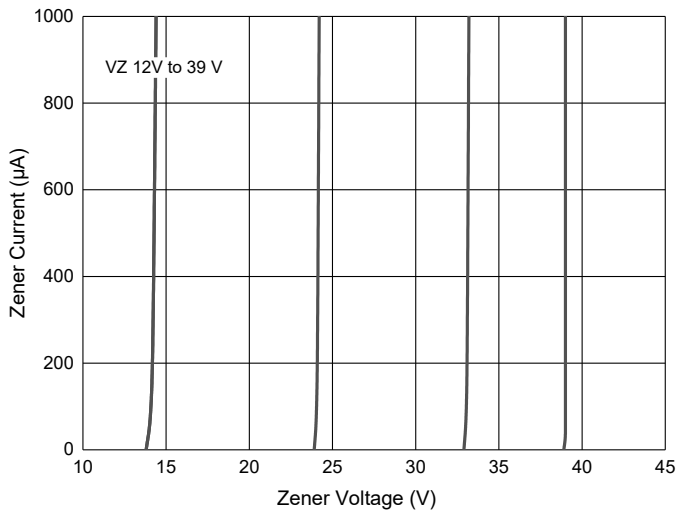

Fig. 3 - Typical Zener Breakdown Characteristics



Ordering Information

Device	Packing
Part Number-TP	Tape&Reel:3Kpcs/Reel
Part Number-13P	Tape&Reel:10Kpcs/Reel

IMPORTANT NOTICE

Micro Commercial Components Corp. reserves the right to make changes without further notice to any product herein to make corrections, modifications, enhancements, improvements, or other changes. *Micro Commercial Components Corp.* does not assume any liability arising out of the application or use of any product described herein; neither does it convey any license under its patent rights, nor the rights of others. The user of products in such applications shall assume all risks of such use and will agree to hold *Micro Commercial Components Corp.* and all the companies whose products are represented on our website, harmless against all damages. *Micro Commercial Components Corp.* products are sold subject to the general terms and conditions of commercial sale, as published at <https://www.mccsemi.com/Home/TermsAndConditions>.

LIFE SUPPORT

MCC's products are not authorized for use as critical components in life support devices or systems without the express written approval of Micro Commercial Components Corporation.

CUSTOMER AWARENESS

Counterfeiting of semiconductor parts is a growing problem in the industry. Micro Commercial Components (MCC) is taking strong measures to protect ourselves and our customers from the proliferation of counterfeit parts. MCC strongly encourages customers to purchase MCC parts either directly from MCC or from Authorized MCC Distributors who are listed by country on our web page cited below. Products customers buy either from MCC directly or from Authorized MCC Distributors are genuine parts, have full traceability, meet MCC's quality standards for handling and storage. **MCC will not provide any warranty coverage or other assistance for parts bought from Unauthorized Sources.** MCC is committed to combat this global problem and encourage our customers to do their part in stopping this practice by buying direct or from authorized distributors.

Looking for pricing, stock, or lifecycle information?

Click below to explore more details on WIN SOURCE:

- ⊖ [View MMSZ4690-TP](#) on WIN SOURCE
- ⊖ [Micro Commercial Co](#) Information

Optimize Your Supply Chain with WIN SOURCE Solutions

- ✓ Global Sourcing Solution
- ✓ Obsolete Management
- ✓ Cost Control Management
- ✓ Shortage Management
- ✓ Alternative Solution
- ✓ Excess Inventory Management