

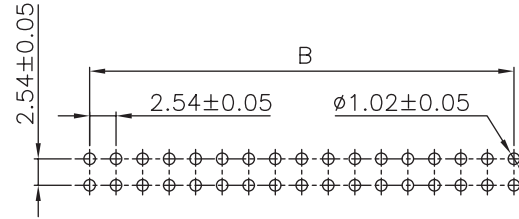

THE DATASHEET OF
61201622821



Notes:
No. of Positions 64 with three key; Other positions with one key



PCB LAYOUT - COMPONENT VIEW

TECHNICAL CHARACTERISTICS

MATERIAL
INSULATOR: PBT
FLAMABILITY RATING: UL94-V0
COLOR: BLACK
CONTACT MATERIAL: COPPER ALLOY
CONTACT TYPE: STAMPED
CONTACT PLATING: GOLD
QUALITY CLASS: 3 AS PER CECC 75 301-802
PITCH: 2.54 MM

ENVIRONMENTAL
OPERATING TEMPERATURE: -40 UP TO 125°C
COMPLIANCE: LEAD FREE AND ROHS

ELECTRICAL
CURRENT RATING: 3 A MAX
WORKING VOLTAGE: 250 VAC
INSULATOR RESISTANCE: >1000 MOHM
DIELECTRIC WITHSTANDING VOLTAGE: 500 VAC/MN
CONTACT RESISTANCE: 20 mOHM MAX

STANDARD
CERTIFIED: E323964

SOLDERING
JEDEC LEAD FREE WAVE SOLDERING PROCESS

PACKAGING
TRAY

DIMENSION

No. of Positions	Dim A	Dim B	No. of Positions	Dim A	Dim B
6	27.12	5.08	26	52.52	30.48
8	29.66	7.62	30	57.60	35.56
10	32.20	10.16	34	62.68	40.64
12	34.74	12.70	40	70.30	48.26
14	37.28	15.24	50	83.00	60.96
16	39.82	17.78	60	95.70	73.66
20	44.90	22.86	64	100.78	78.74
24	49.98	27.94			

Holes left and right appear from polarity 20

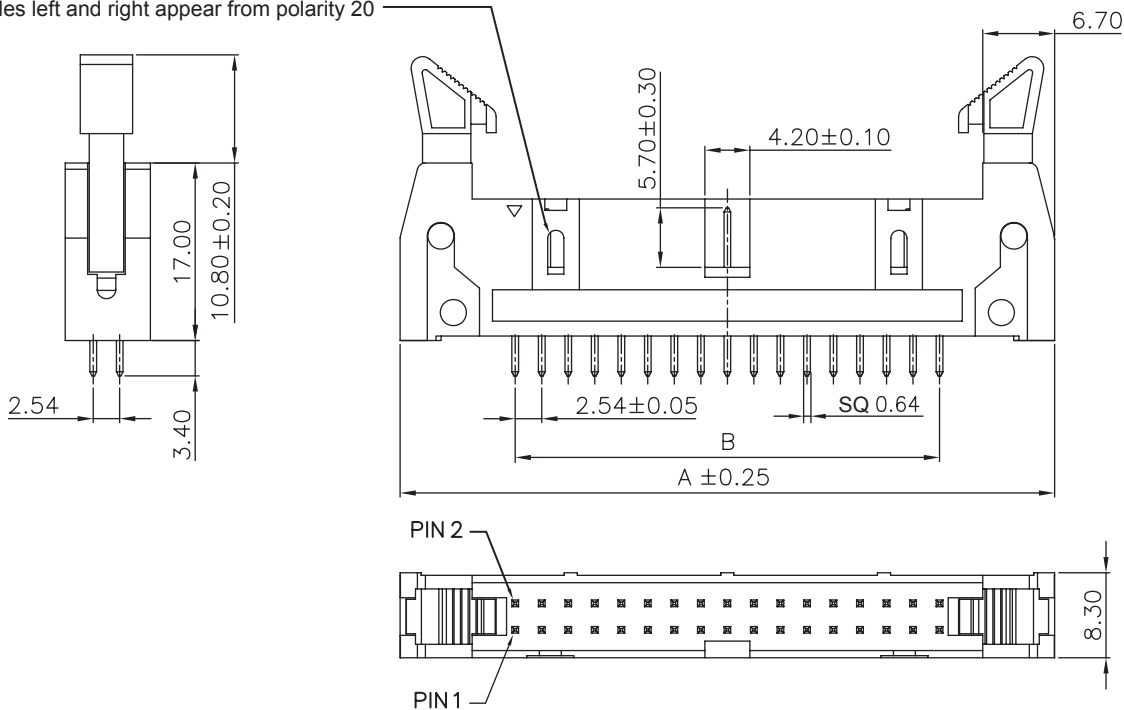

RoHS Compliant	
N	08-DEC-16
M	24-MAR-16
L	20-OCT-15
K	27-JAN-14
J	19-MAR-13
I	22-FEB-13
H	19-DEC-12
REV	DATE

DRAWING	AK
TPK	AK
NOTES	AK
DWG UPDATE	QL
NOTES	AR
OVERWALL DIM	QL
REMOVE UL MARK	QL
FILE	BY

PROJECTION:	APPROVAL: GMo

GENERAL TOLERANCE	UNIT: MM
.X = +/- 0.2	
.XX = +/- 0.15	
SCALE:	
SHEET: 1/3	
DRAW: MIKE	

DESCRIPTION: 2.54MM MALE BOX HEADER WITH LONG LEVER	
WERI PART NO: 612 0xx 228 21	

SIZE
A4

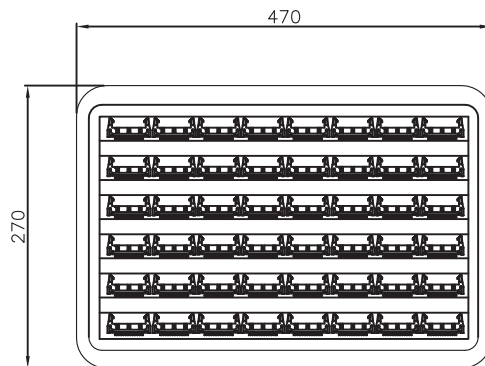
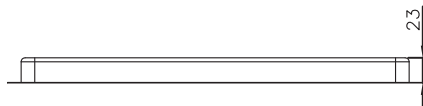
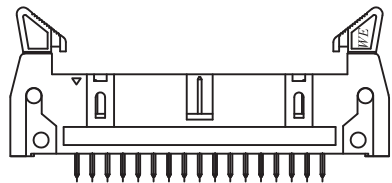

TRAY LAYOUT

Note:

1.Dimension:

Tray Size:470(L)x270(W)x23(H) (mm)

Carton Size:470(L)x270(W)x350(H) (mm)

2.Quantity:

CIRCUITS	PCS/TRAY	TRAYS/CARTON	Q'TY
6	180	15	2700
8	168	15	2520
10	156	15	2340
14	132	15	1980
16	120	15	1800
20	108	15	1620
24-26	96	15	1440
30	84	15	1260
34-40	72	15	1080
50	60	15	900
60-64	48	15	720

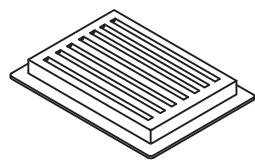

TRAY

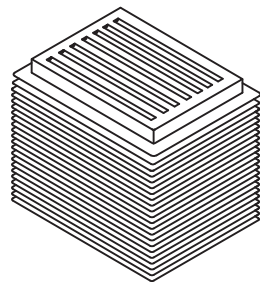

15TRAYS

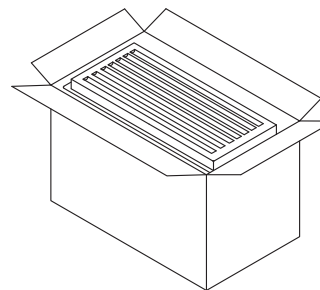
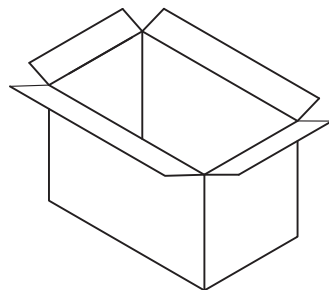

CARTON

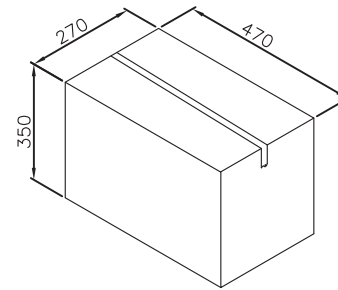

RoHS Compliant			
F			
E			
D			
C			
B			
A			
REV	DATE	FILE	BY

PROJECTION:



GENERAL TOLERANCE

.X = +/- 0.2

.XX = +/- 0.15



APPROVAL: GMo

UNIT: MM

SCALE:

SHEET: 2/3

DRAW: AK

DESCRIPTION: 2.54MM MALE BOX HEADER WITH LONG LEVER

WERI PART NO: 612 0xx 228 21

SIZE

A4

1

2

3

4

5

Cautions and Warnings:

This electronic component is designed and developed with the intention for use in general electronics equipments.

Before incorporating the components into any equipments in the field such as aerospace, aviation, nuclear control, submarine, transportation, (automotive control, train control, ship control), transportation signal, disaster prevention, medical, public information network etc. where higher safety and reliability are especially required or if there is possibility of direct damage or injury to human body, Würth Elektronik must be asked for a written approval.



In addition, even electronic component in general electronic equipments, when used in electrical circuits that require high safety, reliability functions or performance, the sufficient reliability evaluation-check for the safety must be performed before by the user before usage.

A

B

C

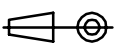
RoHS Compliant

G				PROJECTION: 	GENERAL TOLERANCE .X = +/- 0.2 .XX = +/- 0.15		
F							
E							
D							
C				APPROVAL: JC	UNIT: MM	DESCRIPTION: DISCLAIMER	SIZE A4
B					SCALE:		
A	10-SEP-14	PDF	QL		SHEET: 3/3	WERI PART NO: DISCLAIMER	
REV	DATE	FILE	BY		DRAW: QL		

D

Looking for pricing, stock, or lifecycle information?

Click below to explore more details on WIN SOURCE:

 [View 61201622821 on WIN SOURCE](#)

 [Wurth Electronics Inc Information](#)

Optimize Your Supply Chain with WIN SOURCE Solutions

-  Global Sourcing Solution
-  Obsolete Management
-  Cost Control Management
-  Shortage Management
-  Alternative Solution
-  Excess Inventory Management