



**THE DATASHEET OF  
OP593A**



# NPN Plastic Silicon Phototransistor

## OP593, OP598 Series



### Features:

- Dark blue epoxy package
- Wide receiving angle
- Variety of sensitivity ranges
- TO-18 equivalent package style

### Description:

Each device in this series consists of an NPN silicon phototransistor molded in a dark blue epoxy packages. The wide receiving angle (130°) of the **OP593** series devices provides relatively even reception over a large area. The narrow receiving angle (25°) of the **OP598** series devices provides a relatively small reception area.

*These devices are 100% production tested using infrared light for close correlation with OPTEK's GaAs and GaAlAs emitters.*

*Please refer to Application Bulletins 208 and 210 for additional design information and reliability (degradation) data.*

### Applications:

- Non-contact reflective or slotted sensor
- Assembly line automation
- Machine automation
- Machine Safety
- End of travel sensor
- Door sensor
- Safety Curtain



Pin #	Sensor
1	Collector
2	Emitter

Ordering Information				
Part Number	Sensor	Viewing Angle	Lead Length	
OP593A	Transistor	130°	0.75"	
OP593B				
OP593C (Obsolete)				
OP598A				25°
OP598B				
OP598C				
OP798A (Obsolete)	R <sub>BE</sub> Transistor	25°		
OP798B (Obsolete)				
OP798C (Obsolete)				
OP798D (Obsolete)				
OP798E (Obsolete)				

**OP593**

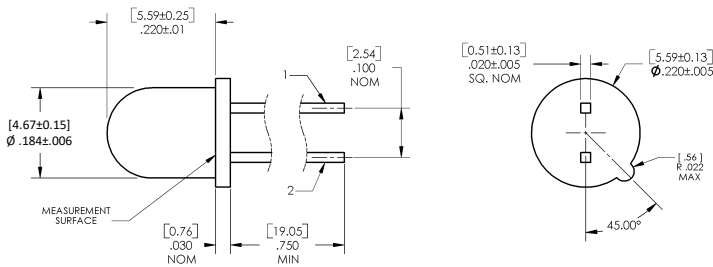

**OP598**

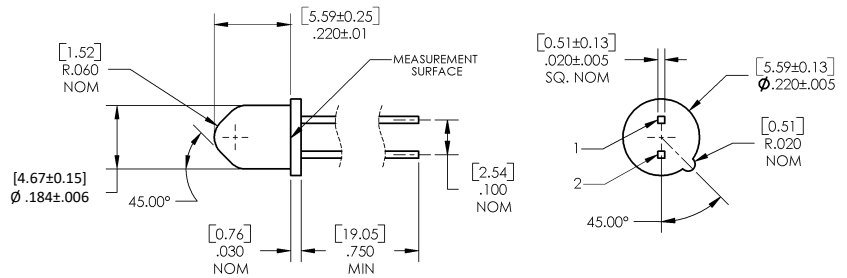

DIMENSIONS ARE IN: [MILLIMETERS] INCHES

### General Note

TT Electronics reserves the right to make changes in product specification without notice or liability. All information is subject to TT Electronics' own data and is considered accurate at time of going to print.

TT Electronics | OPTEK Technology  
2900 E. Plano Pkwy, Plano, TX 75074 | Ph: +1 972 323 2200  
www.ttelectronics.com | sensors@ttelectronics.com

# NPN Plastic Silicon Phototransistor

OP593, OP598 Series



## Electrical Specifications

**Absolute Maximum Ratings** ( $T_A = 25^\circ\text{C}$  unless otherwise noted)

Storage and Operating Temperature Range	-40° C to +100° C
Collector-Emitter Voltage	30 V
Emitter-Collector Voltage	5 V
Continuous Collector Current	50 mA
Lead Soldering Temperature [1/16 inch (1.6 mm) from case for 5 seconds with soldering iron]	260° C <sup>(1)</sup>
Power Dissipation	250 mW <sup>(2)</sup>

**Electrical Characteristics** ( $T_A = 25^\circ\text{C}$  unless otherwise noted)

SYMBOL	PARAMETER	MIN	TYP	MAX	UNITS	TEST CONDITIONS
$I_{C(ON)}$	On-State Collector Current					$V_{CE} = 5\text{ V}$ . Light source is an unfiltered GaAlAs LED with a peak emission wavelength of 890 nm and $E_{e(APT)}$ of 1.7 mW/cm <sup>2</sup> average within a .250" diameter aperture.
	OP593A	3.0	-	4	mA	
	OP593B	2.0	-	4		
	OP598A	7.5	-	10		
	OP598B	5.0	-	10		
OP598C	2.5	-	10			
$I_{CEO}$	Collector-Dark Current	-	-	100	nA	$V_{CE} = 10\text{ V}$ , $E_E = 0$
$V_{(BR)CEO}$	Collector-Emitter Breakdown Voltage	30	-	-	V	$I_C = 100\ \mu\text{A}$
$V_{(BR)ECO}$	Emitter-Collector Breakdown Voltage	5	-	-	V	$I_E = 100\ \mu\text{A}$
$V_{CE(SAT)}$	Collector-Emitter Saturation Voltage	-	-	0.40	V	$I_C = 0.4\text{ mA}$ , $E_E = 1.7\text{ mW/cm}^2$

**General Note**

TT Electronics reserves the right to make changes in product specification without notice or liability. All information is subject to TT Electronics' own data and is considered accurate at time of going to print.

TT Electronics | OPTEK Technology  
2900 E. Plano Pkwy, Plano, TX 75074 | Ph: +1 972 323 2200  
www.ttelectronics.com | sensors@ttelectronics.com

# NPN Plastic Silicon Phototransistor

OP593, OP598 Series



## Performance

OP593, OP598

Typical Spectral Response

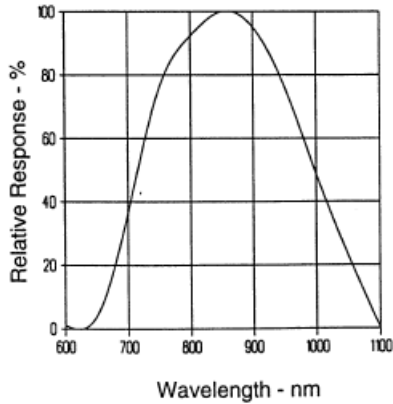

On-State Collector Current vs. Irradiance

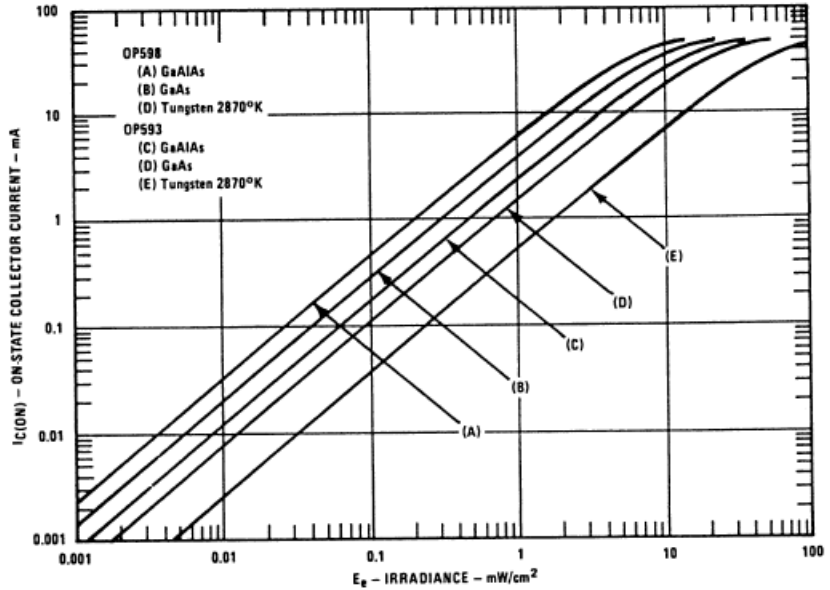

Normalized Collector Current vs. Ambient Temperature

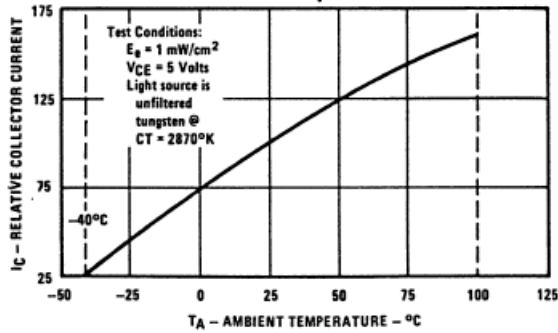

General Note

TT Electronics reserves the right to make changes in product specification without notice or liability. All information is subject to TT Electronics' own data and is considered accurate at time of going to print.

TT Electronics | OPTEK Technology  
 2900 E. Plano Pkwy, Plano, TX 75074 | Ph: +1 972 323 2200  
[www.ttelectronics.com](http://www.ttelectronics.com) | [sensors@ttelectronics.com](mailto:sensors@ttelectronics.com)

# NPN Plastic Silicon Phototransistor

OP593, OP598 Series



## Performance OP593, OP598

Collector Dark Current vs. Ambient Temperature

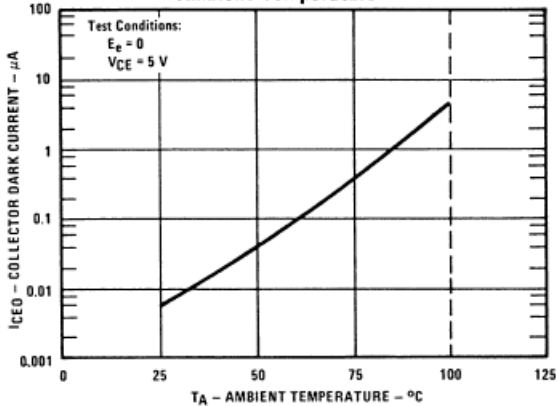

Relative Collector Current vs. Angular Displacement

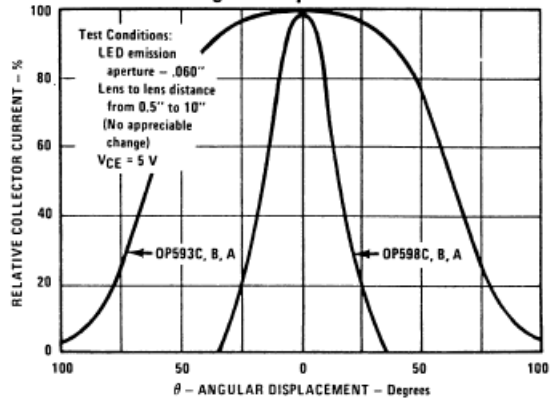

Collector Current vs. Collector to Emitter Voltage

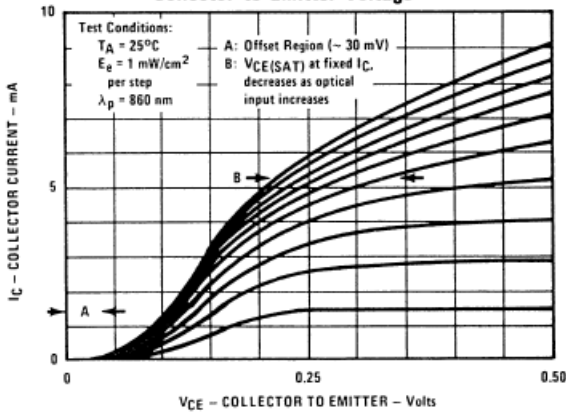

Rise and Fall Time vs. Load Resistance

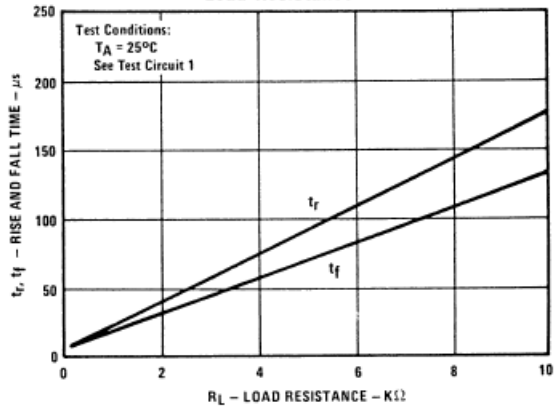

Normalized Output vs. Frequency

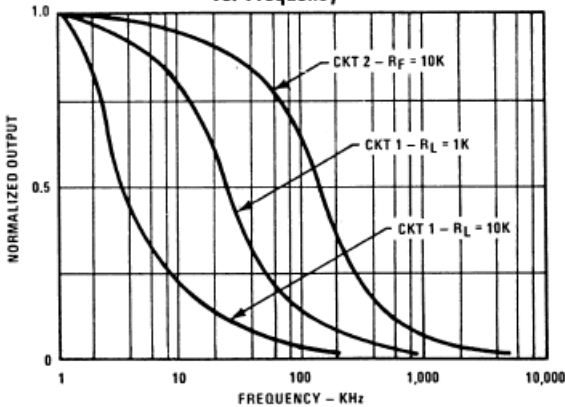

Switching Time Test Circuit

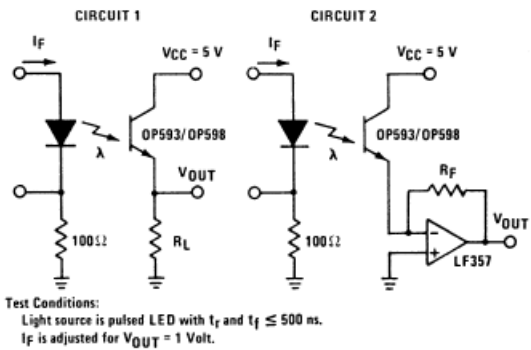

General Note

TT Electronics reserves the right to make changes in product specification without notice or liability. All information is subject to TT Electronics' own data and is considered accurate at time of going to print.

TT Electronics | OPTEK Technology  
2900 E. Plano Pkwy, Plano, TX 75074 | Ph: +1 972 323 2200  
www.ttelectronics.com | sensors@ttelectronics.com

# NPN Plastic Silicon Phototransistor

OP593, OP598 Series



## Performance

OP593, OP598

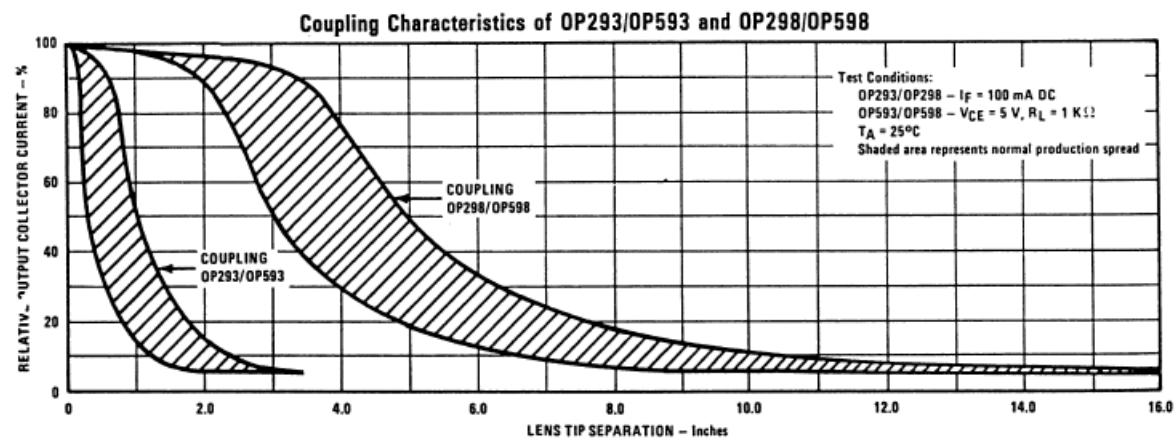
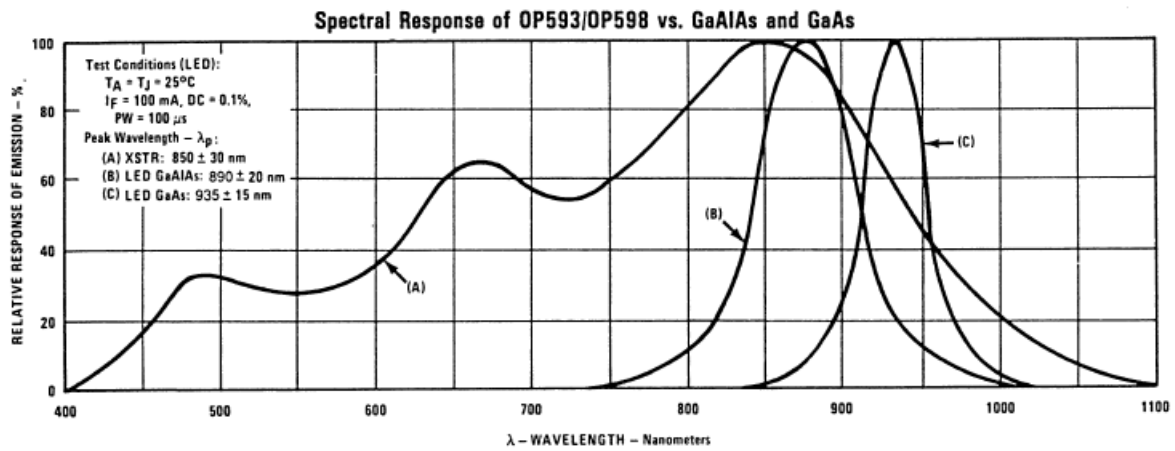
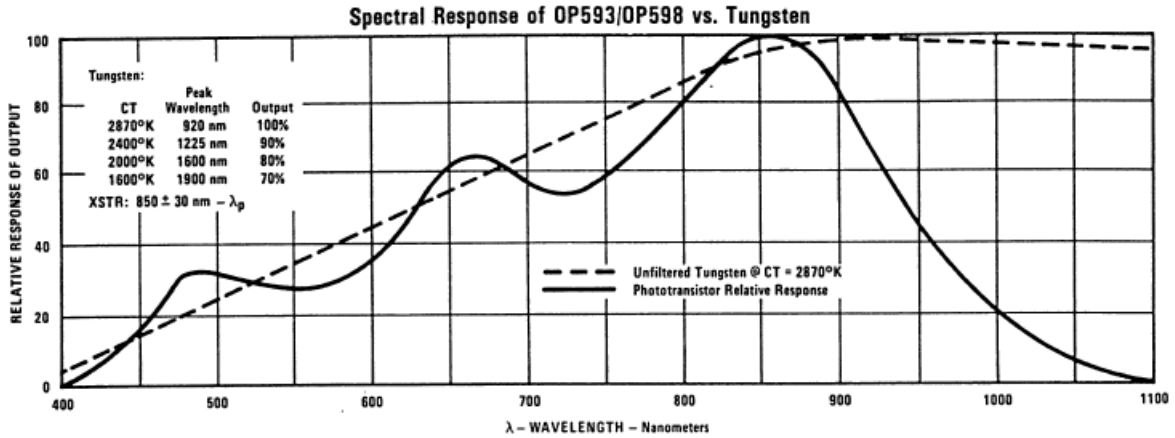

General Note  
 TT Electronics reserves the right to make changes in product specification without notice or liability. All information is subject to TT Electronics' own data and is considered accurate at time of going to print.

TT Electronics | OPTEK Technology  
 2900 E. Plano Pkwy, Plano, TX 75074 | Ph: +1 972 323 2200  
[www.ttelectronics.com](http://www.ttelectronics.com) | [sensors@ttelectronics.com](mailto:sensors@ttelectronics.com)

## Looking for pricing, stock, or lifecycle information?

Click below to explore more details on WIN SOURCE:

 [View OP593A on WIN SOURCE](#)

 [TT Electronics](#) Information

## Optimize Your Supply Chain with WIN SOURCE Solutions

-  Global Sourcing Solution
-  Obsolete Management
-  Cost Control Management
-  Shortage Management
-  Alternative Solution
-  Excess Inventory Management