



**THE DATASHEET OF
REC5-2405SRW/H4/A/M**



Features

Regulated Converters

- 1.6kVDC, 2kVDC, 4kVDC or 6kVDC isolation
- Industry standard 5W DIP24 or SMD package
- Feedback regulated output
- Continuous short circuit protection
- Wide 2:1 or 4:1 input
- 3 case styles
- CTRL pin option (A pinning only)

RECOM
DC/DC Converter

REC5-S(D)RW(Z)

5 Watt
DIP24 or
SMD Case
Single and Dual



C **UL** US
E358085



IEC60950-1 certified
UL60950-1 certified
CAN/CSA-C22.2 No. 60950-1-03 certified
EN55032 compliant

PREFERRED ALTERNATIVES

For new medical applications:

REM5E



Description

This series offers standard isolation of 2kVDC/1s with 4kVDC/1s (= „/H4“) or 6kVDC/1s (= „/H6“) options making it ideal for both industrial, medical and other sophisticated high end applications. Packaging can be either DIP24 non-conductive plastic or 5-side-shielded DIP24 metal case (= option „/M“) as well as DIP24-SMD case (= option „/SMD“). For all the above variants, 2 industry-standard pinouts (= option „/A“ or „/C“) are available. „B“ pinning is also available with „/H“ isolation of 1.6kVDC. Remote on/off control is possible with the /CTRL option („A“ pinning only). The converters can deliver 140% rated power for short periods of time to cope with applications with large capacitive loads or high start up currents.

Selection Guide

Part Number	Input Voltage Range ⁽¹⁾ [VDC]	Output Voltage [VDC]	Output Current [mA]	Efficiency typ. ⁽²⁾ [%]	max. Capacitive Load ⁽³⁾ [µF]
REC5-xx3.3SRW	4.5-9, 9-18, 18-36, 36-72	3.3	1000	75-77	6800
REC5-xx05SRW	9-18, 18-36, 36-72 4.5-9	5	1000	79-81 75	6800
REC5-xx09SRW	9-18, 18-36, 36-72 4.5-9	9	556	82-83 73	6800
REC5-xx12SRW	9-18, 18-36, 36-72 4.5-9	12	420	84-85 74	6800
REC5-xx15SRW	9-18, 18-36, 36-72 4.5-9	15	340	85-86 75	6800
REC5-xx05DRW	9-18, 18-36, 36-72 4.5-9	±5	±500	79-81 72	±2200
REC5-xx09DRW	9-18, 18-36, 36-72 4.5-9	±9	±278	82-84 74	±2200
REC5-xx12DRW	9-18, 18-36, 36-72 4.5-9	±12	±210	84-85 75	±2200
REC5-xx15DRW	9-18, 18-36, 36-72 4.5-9	±15	±170	85-86 75	±2200
REC5-xx3.3SRWZ	9-36, 18-72	3.3	1000	75-76	6800
REC5-xx05SRWZ	9-36, 18-72	5	1000	81-82	6800
REC5-xx09SRWZ	9-36, 18-72	9	556	82-83	6800
REC5-xx12SRWZ	9-36, 18-72	12	420	83-84	6800
REC5-xx15SRWZ	9-36, 18-72	15	340	84-85	6800
REC5-xx05DRWZ	9-36, 18-72	±5	±500	81-82	±2200
REC5-xx09DRWZ	9-36, 18-72	±9	±278	82-84	±2200
REC5-xx12DRWZ	9-36, 18-72	±12	±210	82-83	±2200
REC5-xx15DRWZ	9-36, 18-72	±15	±170	84-85	±2200

Notes:

Note1: Refer to “Input Voltage Range”

Note2: Efficiency is tested at nominal input and full load at +25°C ambient

Note3: Max Cap Load is tested at nominal input and full resistive load

Specifications (measured @ Ta= 25°C, nom. Vin, full load and after warm-up unless otherwise stated)

Efficiency vs. Load

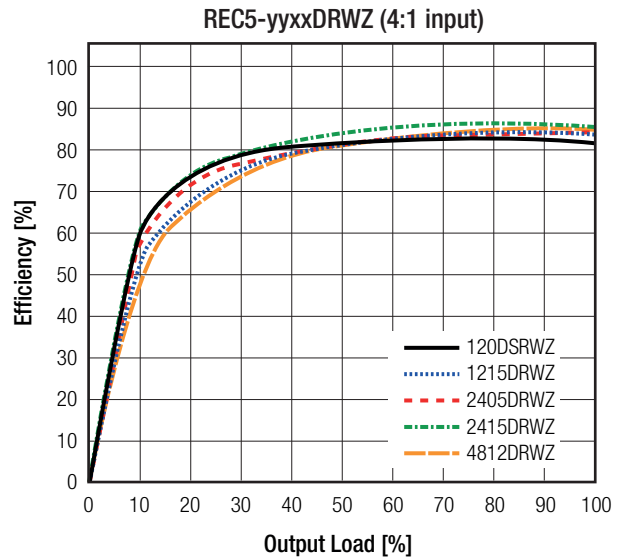
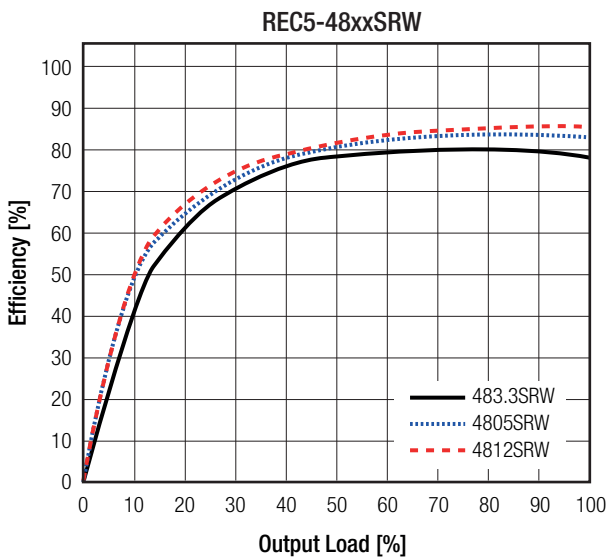
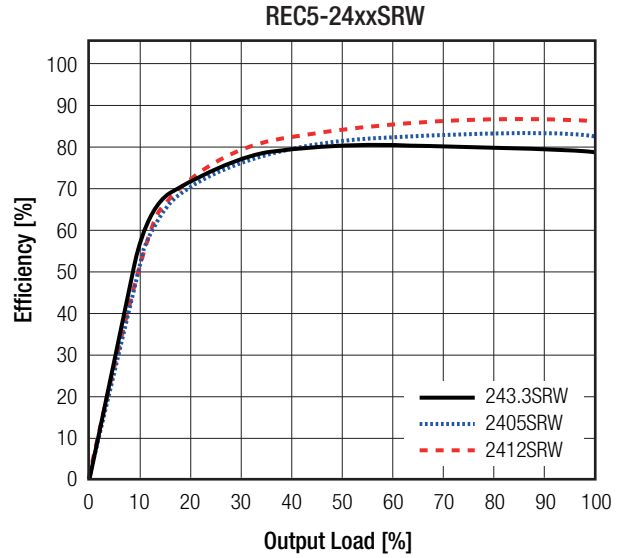
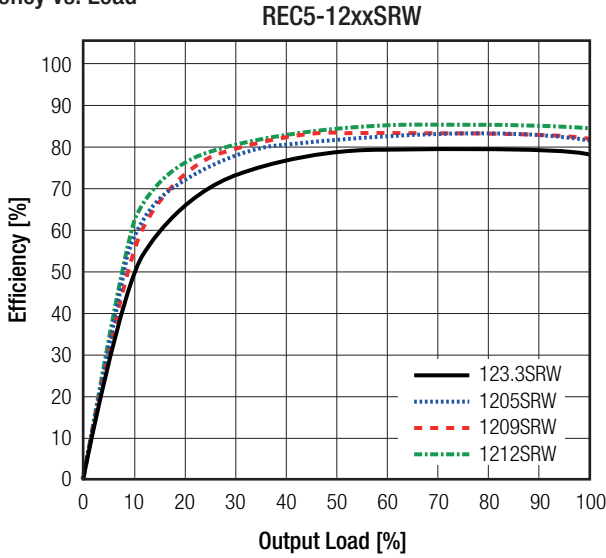

ON/OFF CTRL (“/A” pinning only)

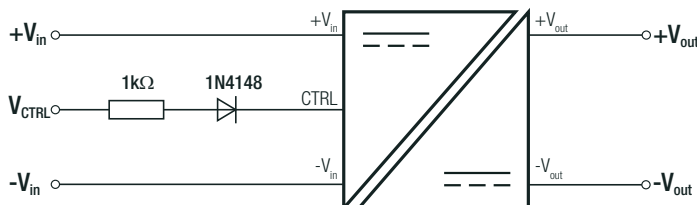

DC-DC ON: $0V < V_{CTRL} < 1.2VDC$
DC-DC OFF: $2.2V < V_{CTRL} < 12VDC$

REGULATIONS

Parameter	Condition	Value
Output Accuracy		±2.0% max.
Line Regulation	low line to high line	±0.3% max.
Load Regulation	20% to 100% load	±0.6% max.

Specifications (measured @ Ta= 25°C, nom. Vin, full load and after warm-up unless otherwise stated)

PROTECTIONS

Parameter	Type	Value	
Short Circuit Protection (SCP) ⁽¹⁴⁾	below 100mΩ	continuous, auto recovery	
Isolation Voltage ⁽¹⁵⁾	with suffix "/H"	tested for 1 second	1.6kVDC
		rated for 1 minute	500VAC/60Hz
	with suffix "/H2"	tested for 1 second	2kVDC
		rated for 1 minute	1kVAC/60Hz
	with suffix "/H3"	tested for 1 second	4kVDC
		rated for 1 minute	2kVAC/60Hz
with suffix "/H6"	tested for 1 second	6kVDC	
	rated for 1 minute	3kVAC/60Hz	
Isolation Resistance		1GΩ min.	
Isolation Capacitance		60pF typ.	
Insulation Grade		functional	

Notes:

Note14: Max. Temperature = +50°C during the short circuit conditions.

Note15: For repeat Hi-Pot testing, reduce the time and/or the test voltage

Note16: Refer to local safety regulations if input over-current protection is also required. Recommended fuse: slow blow type

ENVIRONMENTAL

Parameter	Condition	Value	
Operating Temperature Range	with derating @ free air convection (refer to "Derating Graph")	-40°C to +105°C	
Thermal Impedance	plastic case	20K/W	
	metal case	12K/W	
Operating Altitude		2000m	
Operating Humidity	non-condensing	95% RH max.	
Pollution Degree		PD2	
MTBF	according to MIL-HDBK-217F, G.B.	+25°C	850 x 10 ³ hours
		+75°C	206 x 10 ³ hours

Derating Graph

(@ Chamber and free air convection 0.1m/s)

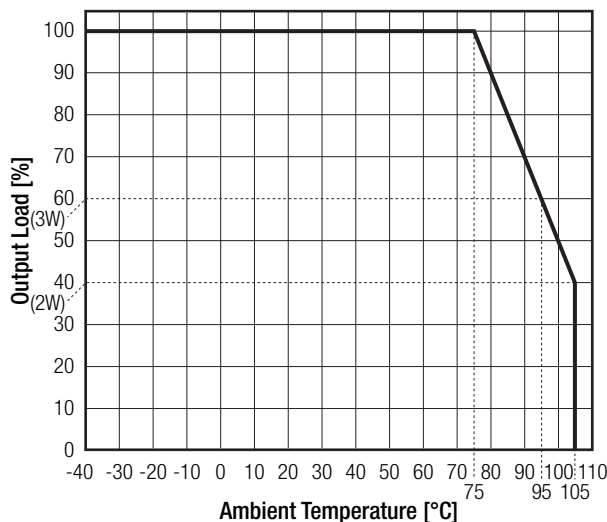

Specifications (measured @ Ta= 25°C, nom. Vin, full load and after warm-up unless otherwise stated)

SAFETY AND CERTIFICATIONS

Certificate Type (Safety)	Report / File Number	Standard
Information Technology Equipment, General Requirements for Safety	E358085	UL60950-1, 1st Edition, 2007 CAN/CSA-C22.2 No. 60950-1-03, 1st Edition, 2006
Information Technology Equipment, General Requirements for Safety	LVD1605077-10	IEC60950-1:2005, 2nd Edition + A2:2013
Medical Electric Equipment, General Requirements for Safety and Essential Performance	SPC1006048	IEC60601-1:1988 + A2:1995 EN60601-1:1990 + A13 :1996
EAC	RU-AT.AB49.B.09571	TP TC 004/2011
RoHS2	TWNC00677039	RoHS, 2011/65/EU + AM-2015/863

EMC Compliance

EMC Compliance	Condition	Standard / Criterion
Electromagnetic compatibility of multimedia equipment - Emission requirements ⁽¹⁷⁾	with external filter (see filter suggestion below)	EN55032, Class A/B

EMC Filtering Suggestions according to EN55032

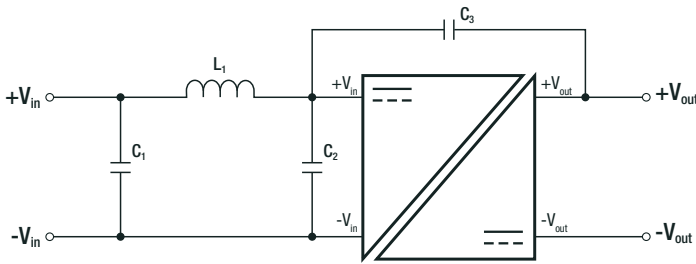

Component List Class A

MODEL	C1	C2	C3	L1
REC5-0505SRW/H4/A	N/A	10µF MLCC	150pF	N/A
REC5-1205SRW/H4/A				12µH RLS-126
REC5-2405SRW/H4/A			330pF	22µH RLS-226
REC5-4805SRW/H2/A				

Component List Class B

MODEL	C1	C2	C3	L1
REC5-0505SRW/H4/A	10µF MLCC	10µF MLCC	150pF	18µH RLS-186
REC5-1205SRW/H4/A				12µH RLS-126
REC5-2405SRW/H4/A			1nF	22µH RLS-226
REC5-4805SRW/H2/A				100µH RLS-105

Notes:

Note17: Filter suggestions are valid for indicated part numbers only. For other part numbers, please contact Recom tech support advice

DIMENSION AND PHYSICAL CHARACTERISTICS

Parameter	Type	Value	
Material	plastic case	non-conductive black plastic, (UL94 V-0)	
	metal case ("M" option)	nickel plated copper	
	PCB	FR4, (UL94 V-0)	
	potting	epoxy, (UL94 V-0)	
Dimension (LxWxH)	DIP24	plastic case	31.8 x 20.3 x 10.2mm
		metal case ("M" option)	32.0 x 20.3 x 10.5mm
	SMD	plastic case	31.8 x 20.3 x 10.9mm
		metal case ("M" option)	32.0 x 20.3 x 10.9mm
Weight		13g typ.	

continued on next page

Specifications (measured @ Ta= 25°C, nom. Vin, full load and after warm-up unless otherwise stated)

Dimension Drawing DIP24 plastic case (mm)

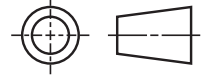

„A“ Pinning (/H2, /H4, /H6)

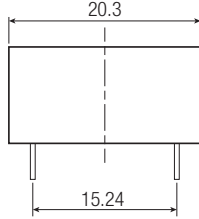
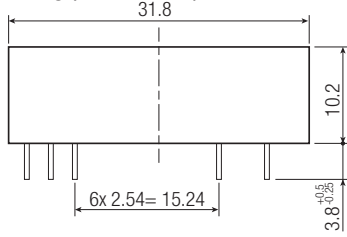

CTRL option

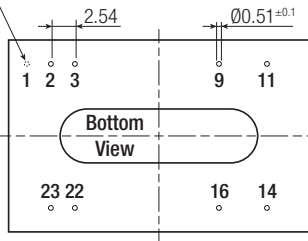

Recommended Footprint Details

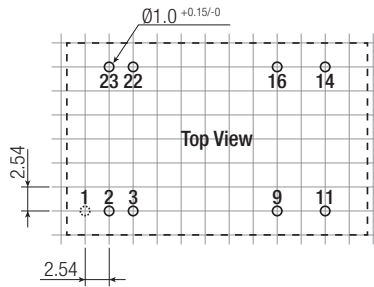

„A“ Pinning (/H2,/H4,/H6)

Pin #	Single	Single/X2	Dual
1 „Note8“	CTRL	CTRL	CTRL
2,3	-Vin	-Vin	-Vin
9	NC	no pin	Com
11	NC	NC	-Vout
14	+Vout	+Vout	+Vout
16	-Vout	-Vout	Com
22,23	+Vin	+Vin	+Vin

NC= No Connection

„B“ Pinning (/H only)

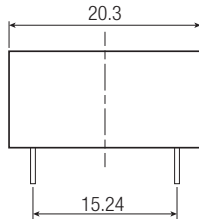
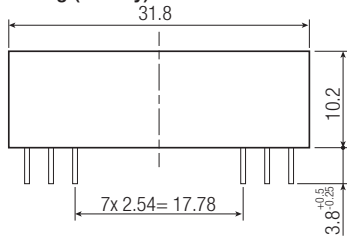

CTRL option

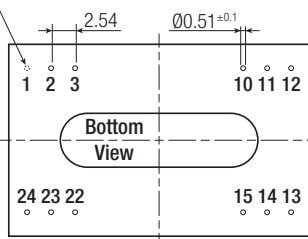

Recommended Footprint Details

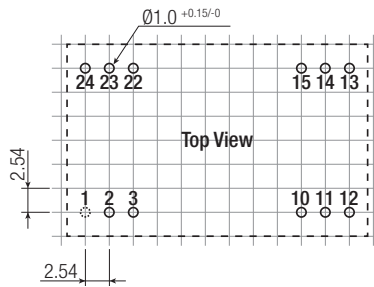

„B“ Pinning (/H only)

Pin #	Single	Dual
1	+Vin	+Vin
2	no pin	-Vout
3	no pin	Com
10	-Vout	Com
11,14	+Vout	+Vout
12,13	-Vin	-Vin
15	-Vout	Com
22	no pin	Com
23	no pin	-Vout
24	+Vin	+Vin

„C“ Pinning (/H2, /H4, /H6)

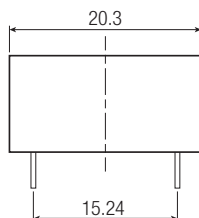
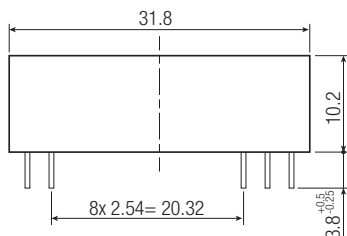

CTRL option

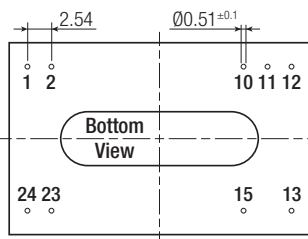

Recommended Footprint Details

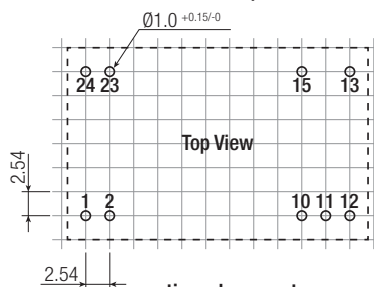

„C“ Pinning (/H2,/H4,/H6)

Pin #	Single	Dual
1,2	+Vin	+Vin
10,11	NC	COM
12	-Vout	NC
13	+Vout	-Vout
15	NC	+Vout
23,24	-Vin	-Vin

NC= No Connection

continued on next page

tolerance ±0.25mm

Specifications (measured @ Ta= 25°C, nom. Vin, full load and after warm-up unless otherwise stated)

Dimension Drawing SMD plastic case (mm)

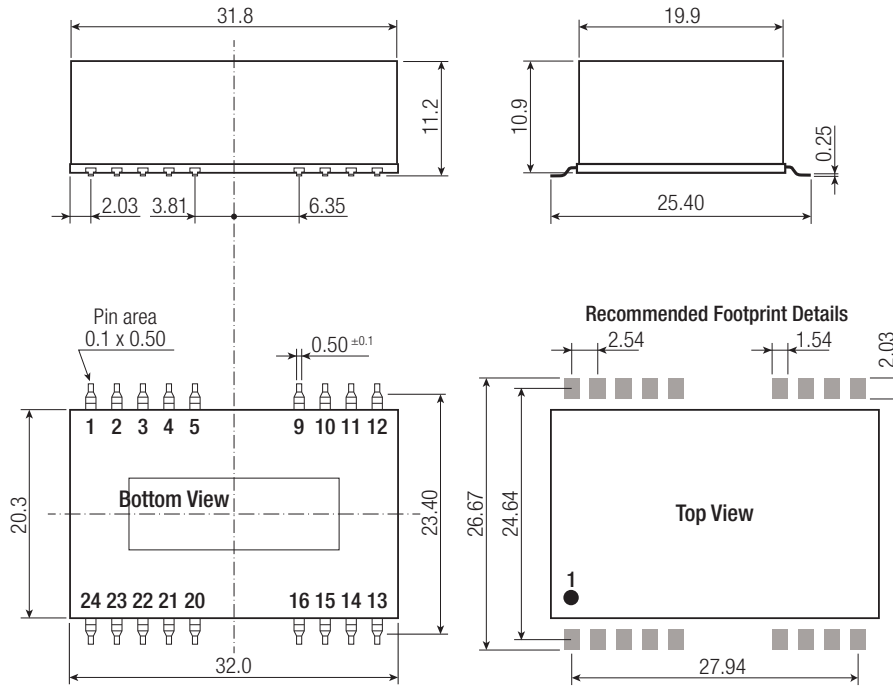

„A“ Pinning

Pin #	Single	Dual
1 <small>„Note8“</small>	CTRL	CTRL
2,3	-Vin	-Vin
4,5	NC	NC
9	NC	Com
10,12,13,15	NC	NC
11	NC	-Vout
14	+Vout	+Vout
16	-Vout	Com
20,21,24	NC	NC
22,23	+Vin	+Vin

NC= No Connection

„B“ Pinning

Pin #	Single	Dual
1	+Vin	+Vin
2	NC	-Vout
3	NC	Com
4,5,9	NC	NC
10	-Vout	Com
11	+Vout	+Vout
12,13	-Vin	-Vin
14	+Vout	+Vout
15	-Vout	Com
16,20,21	NC	NC
22	NC	Com
23	NC	-Vout
24	+Vin	+Vin

NC= No Connection

„C“ Pinning

Pin #	Single	Dual
1,2	+Vin	+Vin
3,4,5,9	NC	NC
10,11	NC	Com
12	-Vout	NC
13	+Vout	-Vout
14	NC	NC
15	NC	+Vout
16,20,21,22	NC	NC
23,24	-Vin	-Vin

NC= No Connection

Notes:

Note18: All models with plastic housings have an embossed RECOM logo. See below top view:

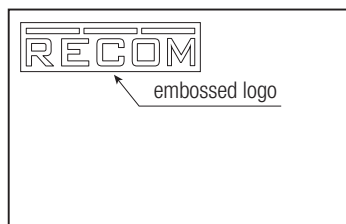

continued on next page

tolerance ±0.35mm

Specifications (measured @ Ta= 25°C, nom. Vin, full load and after warm-up unless otherwise stated)

Dimension Drawing DIP24 metal case (mm)

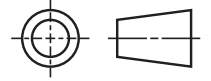

„A“ Pinning (/H2, /H4, /H6)

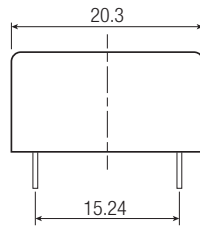
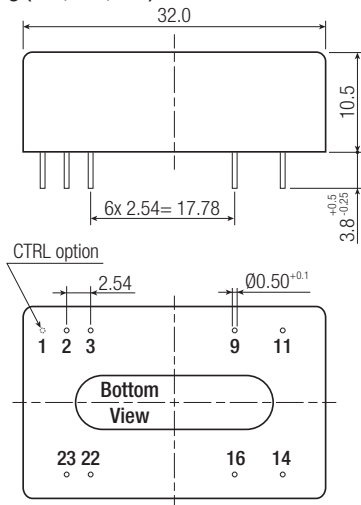

Recommended Footprint Details

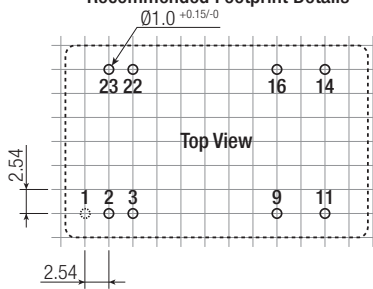

„A“ Pinning (/H2,/H4,/H6)

Pin #	Single	Single/X2	Dual
1 „Note8“	CTRL	CTRL	CTRL
2,3	-Vin	-Vin	-Vin
9	NC	no pin	Com
11	NC	NC	-Vout
14	+Vout	+Vout	+Vout
16	-Vout	-Vout	Com
22,23	+Vin	+Vin	+Vin

NC: No Connection

„B“ Pinning (/H only)

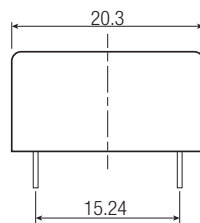
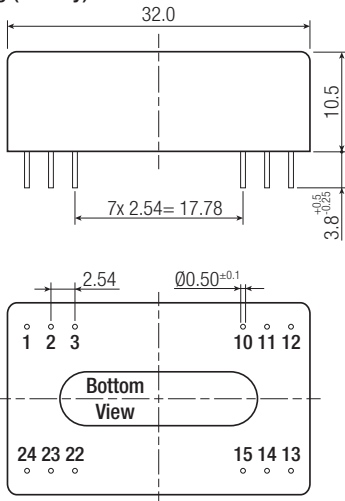

Recommended Footprint Details

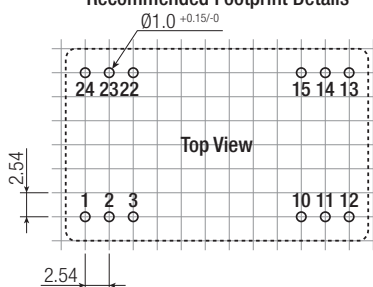

„B“ Pinning (/H only)

Pin #	Single	Dual
1	+Vin	+Vin
2	no pin	-Vout
3	no pin	Com
10	-Vout	Com
11,14	+Vout	+Vout
12,13	-Vin	-Vin
15	-Vout	Com
22	no pin	Com
23	no pin	-Vout
24	+Vin	+Vin

NC= No Connection

„C“ Pinning (/H2, /H4, /H6)

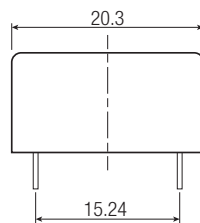
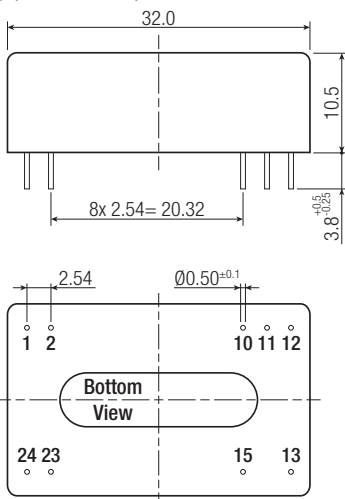

Recommended Footprint Details

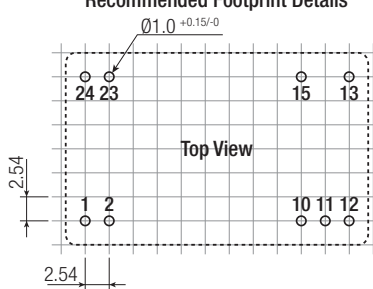

„C“ Pinning (/H2,/H4,/H6)

Pin #	Single	Dual
1,2	+Vin	+Vin
10,11	NC	COM
12	-Vout	NC
13	+Vout	-Vout
15	NC	+Vout
23,24	-Vin	-Vin

NC= No Connection

tolerance ±0.25mm

continued on next page

Specifications (measured @ Ta= 25°C, nom. Vin, full load and after warm-up unless otherwise stated)

Dimension Drawing SMD metal case (mm)

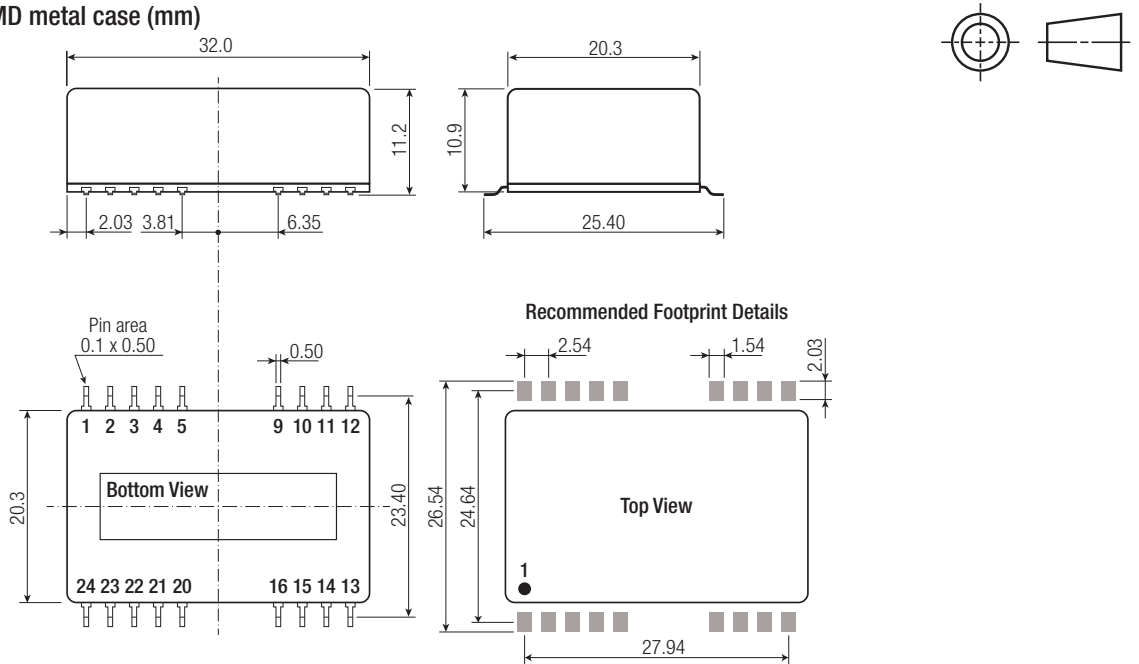

„A“ Pinning

Pin #	Single	Dual
1 „Note8“	CTRL	CTRL
2,3	-Vin	-Vin
4,5	NC	NC
9	NC	Com
10,12,13,15	NC	NC
11	NC	-Vout
14	+Vout	+Vout
16	-Vout	Com
20,21,24	NC	NC
22,23	+Vin	+Vin

NC= No Connection

„B“ Pinning

Pin #	Single	Dual
1	+Vin	+Vin
2	NC	-Vout
3	NC	Com
4,5,9	NC	NC
10	-Vout	Com
11	+Vout	+Vout
12,13	-Vin	-Vin
14	+Vout	+Vout
15	-Vout	Com
16,20,21	NC	NC
22	NC	Com
23	NC	-Vout
24	+Vin	+Vin

NC= No Connection

„C“ Pinning

Pin #	Single	Dual
1,2	+Vin	+Vin
3,4,5,9	NC	NC
10,11	NC	Com
12	-Vout	NC
13	+Vout	-Vout
14	NC	NC
15	NC	+Vout
16,20,21,22	NC	NC
23,24	-Vin	-Vin

NC= No Connection

tolerance ±0.35mm

PACKAGING INFORMATION

Parameter	Type	Value	
Packaging Dimension (LxWxH)	tube	THT	530.0 x 23.0 x 19.0mm
		SMD	530.0 x 32.0 x 19.0mm
	tape and reel (“-R” only)	355.0 x 342.0 x 70.0mm	
Tape Width		44mm	
Packaging Quantity	tube	15pcs	
	tape and reel	100pcs	
Storage Temperature Range		-55°C to +125°C	
Storage Humidity	non-condensing	95% RH max.	

The product information and specifications may be subject to changes even without prior written notice. The product has been designed for various applications; its suitability lies in the responsibility of each customer. The products are not authorized for use in safety-critical applications without RECOM's explicit written consent. A safety-critical application is an application where a failure may reasonably be expected to endanger or cause loss of life, inflict bodily harm or damage property. The applicant shall indemnify and hold harmless RECOM, its affiliated companies and its representatives against any damage claims in connection with the unauthorized use of RECOM products in such safety-critical applications.

Looking for pricing, stock, or lifecycle information?

Click below to explore more details on WIN SOURCE:

- ⊖ [View REC5-2405SRW/H4/A/M on WIN SOURCE](#)
- ⊖ [Recom Power Information](#)

Optimize Your Supply Chain with WIN SOURCE Solutions

- ✓ Global Sourcing Solution
- ✓ Obsolete Management
- ✓ Cost Control Management
- ✓ Shortage Management
- ✓ Alternative Solution
- ✓ Excess Inventory Management