



**THE DATASHEET OF
LTM4655EY#PBF**



EN55022B Compliant 40V, Dual 4A or Single 8A Step-Down or 50W Inverting μ Module Regulator

FEATURES

- Dual 4A/Single 8A Low EMI Switch Mode Power Supply
- EN55022 Class B Compliant
- Two Fully Independent Channels, Each Configurable for Positive or Negative Output Voltage Polarity
- Output Voltage Range: $0.5V \leq |V_{OUTn}^+ - V_{OUTn}^-| \leq 26.5V$
- Wide Input Voltage Range: Up to 40V
 - 3.1V or 3.6V Start-Up, Configuration-Dependent
- $\pm 1.67\%$ Total DC Output Voltage Error Over Line, Load and Temperature
- Analog Output Current Indicator (Positive- V_{OUT} Only)
- LDO_{OUT}: 5V Fixed, 25mA Capable LDO
- Parallelable with LTM4651/LTM4653
- Constant-Frequency Current Mode Control
- Power Good Indicators and Programmable Soft-Start
- Overcurrent and Overtemperature Protection
- 16mm \times 16mm \times 5.01mm BGA Package

APPLICATIONS

- Automated Test and Measurement
- Avionics and Industrial Control Systems
- Video, Imaging and Instrumentation

DESCRIPTION

The LTM[®]4655 is an ultralow noise 40V, dual 4A or single 8A DC/DC μ Module[®] regulator designed to meet the radiated emissions requirements of EN55022. Its channels are fully independent, parallelable and capable of delivering positive or negative output polarity. Conducted emission requirements can be met by adding standard filter components. Included in the package are the switching controllers, power MOSFETs, inductors, filters and support components. A 5V, 25mA LDO and clock generator enable phase interleaving of the power switching stages, for improved EMC performance.

The LTM4655 can regulate positive V_{OUTn}^+ voltages between 0.5V and 26.5V from a 3.1V to 40V input. The LTM4655 can regulate negative V_{OUTn}^- voltages between $-0.5V$ and $-26.5V$ from a maximum input range of 3.6V to 40V, with the span from V_{INn} to V_{OUTn}^- not to exceed 40V. A switching frequency range of 250kHz to 3MHz is supported.

The LTM4655 is offered in a 16mm \times 16mm \times 5.01mm BGA package with SnPb or RoHS compliant terminal finish.

All registered trademarks and trademarks are the property of their respective owners. Protected by U.S. Patents, including 5481178, 5705919, 5847554, 6580258.

TYPICAL APPLICATION

Concurrent, $\pm 12V$ Output DC/DC μ Module Regulator*

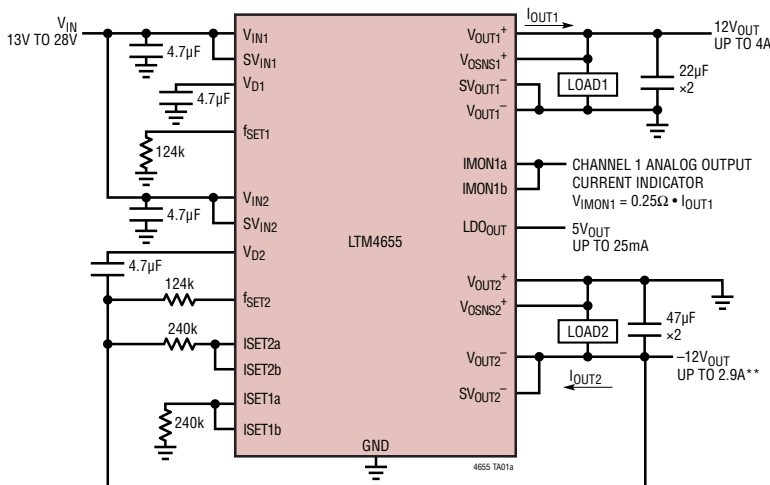

* FOR COMPLETE CIRCUIT, SEE FIGURE 50.

** FOR CHANNELS CONFIGURED TO REGULATE NEGATIVE V_{OUTn}^- : CURRENT LIMIT FREQUENCY-FOLDBACK INCEPTION IS A FUNCTION OF V_{INn} , V_{OUTn}^- , AND f_{SWn} . CONTINUOUS OUTPUT CURRENT CAPABILITY IS SUBJECT TO DETAILS OF APPLICATION IMPLEMENTATION. SEE NOTES 2 AND 3 AND THE APPLICATIONS INFORMATION SECTION, FOR DETAILS.

Output Voltage Start-Up Waveforms

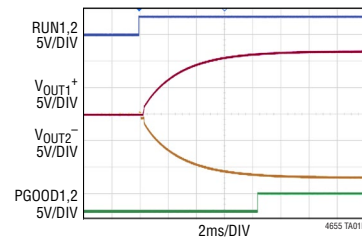

TABLE OF CONTENTS

Features	1	Loop Compensation.....	29
Applications	1	Hot Plugging Safely	30
Typical Application	1	Input Disconnect/Input Short Considerations.....	30
Description	1	INTV _{CCn} and EXT _{VCCn} Connection.....	30
Absolute Maximum Ratings	3	Multiphase Operation.....	31
Pin Configuration	3	Negative Output Current Capability Varies as a Function of V _{INn} to V _{OUTn} ⁻ Conversion Ratios, Negative-V _{OUT} ⁻ Operation.....	32
Order Information	4	Input Capacitors, Negative-V _{OUT} ⁻ Operation.....	33
Electrical Characteristics	4	Output Capacitors, Negative-V _{OUT} ⁻ Operation	34
Typical Performance Characteristics	10	Optional Diodes to Guard Against Overstress, Negative-V _{OUT} ⁻ Operation.....	34
Pin Functions	14	Frequency Adjustment, Negative-V _{OUT} ⁻ Operation	35
Simplified Block Diagram	21	Radiated EMI Noise	36
Test Circuit	22	Thermal Considerations and Output Current Derating	36
Decoupling Requirements	24	Safety Considerations.....	47
Operation	25	Layout Checklist/Example	47
Power Module Overview	25	Typical Applications	48
V _{IN} to V _{OUT} Conversion Ratios.....	26	Package Description	53
Input Capacitors, Positive-V _{OUT} Operation	26	Revision History	55
Output Capacitors, Positive-V _{OUT} Operation	27	Package Photos	56
Forced Continuous Operation	27	Design Resources	56
Output Voltage Programming, Tracking and Soft-Start.....	27	Related Parts	56
Frequency Adjustment.....	28		
Applications Information	29		
Power Module Protection	29		
RUN Pin Enable.....	29		

ABSOLUTE MAXIMUM RATINGS

(Note 1 and Note 5)

Channel 1 Terminal Voltages (All Channel 1 Terminal Voltages Relative to V_{OUT1-} Unless Otherwise Indicated)

V_{IN1} , V_{D1} , SV_{IN1} , SV_{INF1} , $SW1$	-0.3V to 42V
GND , $EXTV_{CC1}$, V_{OUT1+} , V_{OSNS1+} , ISET1a, ISET1b	-0.3V to 28V
$INTV_{CC1}$, $PGDFB1$, $VINREG1$, $COMP1a$, IMON1a, IMON1b	-0.3V to 4V
f_{SET1}	-0.3V to $INTV_{CC1}$
$RUN1$	GND -0.3V to $V_{OUT1-} + 32V$
$PGOOD1$, $CLKIN1$ (Relative to GND)	-0.3V to 6V

Channel 2 Terminal Voltages (All Channel 2 Terminal Voltages Relative to V_{OUT2-} Unless Otherwise Indicated)

V_{IN2} , V_{D2} , SV_{IN2} , SV_{INF2} , $SW2$	-0.3V to 42V
GND , $EXTV_{CC2}$, V_{OUT2+} , V_{OSNS2+} , ISET2a, ISET2b	-0.3V to 28V
$INTV_{CC2}$, $PGDFB2$, $VINREG2$, $COMP2a$, IMON2a, IMON2b	-0.3V to 4V
f_{SET2}	-0.3V to $INTV_{CC2}$
$RUN2$	GND -0.3V to $V_{OUT2-} + 32V$
$PGOOD2$, $CLKIN2$ (Relative to GND)	-0.3V to 6V

LDO and Clock Generator Voltages (All LDO and Clock Generator Terminal Voltages Relative to GND Unless Otherwise Indicated)

LDO_{IN}	-0.3V to 42V
$CLKSET$, MOD	-0.3V to $LDO_{OUT} + 0.3V$

Terminal Currents

$INTV_{CCn}$ Peak Output Current (Note 10)	30mA
$TEMP^+$	-1mA to 10mA
$TEMP^-$	-10mA to 1mA

Temperatures Internal Operating Temperature

Range (Note 2 and Note 9)	
E- and I-Grade	-40°C to 125°C
MP-Grade	-55°C to 125°C
Storage Temperature Range	-55°C to 125°C
Peak Package Body Temperature During Reflow ..	245°C

PIN CONFIGURATION

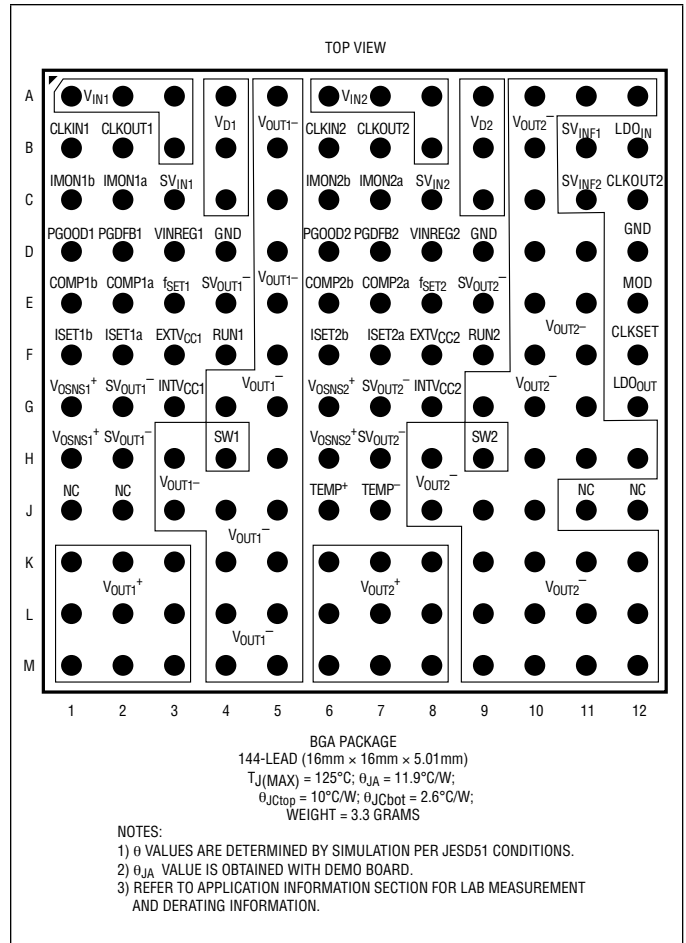

ORDER INFORMATION

PART NUMBER	PAD OR BALL FINISH	PART MARKING*		PACKAGE TYPE	MSL RATING	TEMPERATURE RANGE (SEE NOTE 2)
		DEVICE	FINISH CODE			
LTM4655EY#PBF	SAC305 (RoHS)	LTM4655Y	e1	BGA	3	-40°C to 125°C
LTM4655IY#PBF	SAC305 (RoHS)	LTM4655Y	e1	BGA	3	-40°C to 125°C
LTM4655MPY#PBF	SAC305 (RoHS)	LTM4655Y	e1	BGA	3	-55°C to 125°C
LTM4655IY	SnPb (63/37)	LTM4655Y	e0	BGA	3	-40°C to 125°C
LTM4655MPY	SnPb (63/37)	LTM4655Y	e0	BGA	3	-55°C to 125°C

- Contact the factory for parts specified with wider operating temperature ranges. *Pad or ball finish code is per IPC/JEDEC J-STD-609.
- [Recommended LGA and BGA PCB Assembly and Manufacturing Procedures](#)
- [LGA and BGA Package and Tray Drawings](#)

ELECTRICAL CHARACTERISTICS The ● denotes the specifications which apply over the specified internal operating temperature range (Note 2). Specified as each individual output channel (Note 5). $T_A = 25^\circ\text{C}$, Test Circuit 1 (positive- V_{OUT} , noninverting step-down configuration with $V_{OUTn-} = \text{GND}$, $V_{INn} = \text{SV}_{INn} = 36\text{V}$, $\text{EXTV}_{CCn} = 24\text{V}$, $\text{RUNn} = 3.3\text{V}$, $\text{R}_{\text{ISETn}} = 480\text{k}$, $\text{R}_{\text{ISETn}^+} = 57.6\text{k}\Omega$, $f_{\text{SWn}} = 1.5\text{MHz}$ (CLKINn driven with 1.5MHz clock signal) and voltages referred to GND unless otherwise noted.

SYMBOL	PARAMETER	CONDITIONS	MIN	TYP	MAX	UNITS
$\text{SV}_{\text{INn}(\text{DC})}$, $V_{\text{INn}(\text{DC})}$	Input DC Voltage in Positive- V_{OUT} Configuration	$V_{\text{OUTn}^-} = \text{GND}$	● 3.1		40	V
$V_{\text{OUTn}(\text{RANGE})}^+$	Range of Positive Output Voltage Regulation	$0.5\text{V} \leq \text{ISETna} - \text{SV}_{\text{OUTn}^-} \leq 26.5\text{V}$, $I_{\text{OUTn}^+} = 0\text{A}$ (See Note 7)	● 0.5		26.5	V
$V_{\text{OUTn}(24\text{VDC})}^+$	Output Voltage Total Variation with Line and Load at $V_{\text{OUTn}^+} = 24\text{V}$	$29\text{V} \leq V_{\text{INn}} \leq 40\text{V}$, $0\text{A} \leq I_{\text{OUTn}^+} \leq 4\text{A}$, $C_{\text{INHn}} = 4.7\mu\text{F}$, $C_{\text{Dn}} = 4.7\mu\text{F}$, $C_{\text{OUTHn}} = 2 \times 47\mu\text{F}$, CLKINn Driven with 1.5MHz Clock	● 23.6	24	24.4	V
$V_{\text{OUTn}(0.5\text{VDC})}^+$	Output Voltage Total Variation with Line and Load at $V_{\text{OUTn}^+} = 0.5\text{V}$	Measuring V_{OSNSn^+} to ISETna $3.1\text{V} \leq V_{\text{INn}} \leq 13.2\text{V}$, $0\text{A} \leq I_{\text{OUTn}^+} \leq 4\text{A}$, $C_{\text{INHn}} = 4.7\mu\text{F}$, $C_{\text{Dn}} = 4.7\mu\text{F}$, $C_{\text{OUTHn}} = 2 \times 47\mu\text{F}$, ISETna = 500mV, $\text{R}_{\text{ISETn}} = \text{N/U}$ (Note 6)	● -15	0	15	mV
R_{SVINFn}	Resistor Between SV_{INn} and SV_{INFn}			1		Ω

Input Specifications

$V_{\text{INn}(\text{UVLO})}$	SV_{INn} Undervoltage Lockout Threshold	SV_{INn} Rising SV_{INn} Falling Hysteresis	● 2.4 ● 150	2.85 2.6 250	3.1 2.9	V V mV
$I_{\text{INRUSH}}(V_{\text{INn}})$	Input Inrush Current at Start-Up	$C_{\text{INHn}} = 4.7\mu\text{F}$, $C_{\text{Dn}} = 4.7\mu\text{F}$, $C_{\text{OUTHn}} = 2 \times 47\mu\text{F}$; $I_{\text{OUTn}^+} = 0\text{A}$, ISETna Electrically Connected to ISETnb		300		mA
$I_{\text{Q}}(\text{SVINn})$	Input Supply Bias Current	Shutdown, $\text{RUNn} = \text{GND}$ $\text{RUNn} = 3.3\text{V}$		16 450	30	μA μA
$I_{\text{S}}(V_{\text{INn}})$	Input Supply Current	CLKINn Open Circuit, $I_{\text{OUTn}^+} = 4\text{A}$		2.9		A
$I_{\text{S}}(V_{\text{INn}}, \text{SHUTDOWN})$	Input Supply Current in Shutdown	Shutdown, $\text{RUNn} = \text{GND}$		4		μA

Output Specifications

I_{OUTn^+}	V_{OUTn^+} Output Continuous Current Range	(Note 3)		0	4	A
$\frac{\Delta V_{\text{OUTn}(\text{LINE})}^+}{V_{\text{OUTn}^+}}$	Line Regulation Accuracy	$I_{\text{OUTn}^+} = 0\text{A}$, $29\text{V} \leq V_{\text{INn}} \leq 40\text{V}$	●	0.05	0.1	%
$\frac{\Delta V_{\text{OUTn}(\text{LOAD})}^+}{V_{\text{OUTn}^+}}$	Load Regulation Accuracy	$V_{\text{INn}} = 36\text{V}$, $0\text{A} \leq I_{\text{OUTn}^+} \leq 4\text{A}$	●	0.05	0.75	%
$V_{\text{OUTn}(\text{AC})}^+$	Output Voltage Ripple, V_{OUTn^+}	$V_{\text{INn}} = 12\text{V}$, ISETna = 5V		2		mV _{p-p}

ELECTRICAL CHARACTERISTICS The ● denotes the specifications which apply over the specified internal operating temperature range (Note 2). Specified as each individual output channel (Note 5). $T_A = 25^\circ\text{C}$, Test Circuit 1 (positive- V_{OUTn}^+ , noninverting step-down configuration with $V_{OUTn}^- = \text{GND}$), $V_{INn} = \text{SV}_{INn} = 36\text{V}$, $\text{EXTV}_{CCn} = 24\text{V}$, $\text{RUN}n = 3.3\text{V}$, $R_{ISETn} = 480\text{k}\Omega$, $R_{fSETn}^+ = 57.6\text{k}\Omega$, $f_{SWn} = 1.5\text{MHz}$ (CLKIN n driven with 1.5MHz clock signal) and voltages referred to GND unless otherwise noted.

SYMBOL	PARAMETER	CONDITIONS	MIN	TYP	MAX	UNITS	
f_{SN}	V_{OUTn}^+ Ripple Frequency	$R_{fSETn} = 57.6\text{k}\Omega$, CLKIN n Open Circuit	● 1.7	1.95	2.2	MHz	
$\Delta V_{OUTn(\text{START})}^+$	Turn-On Overshoot			8		mV	
$t_{\text{START}n}$	Turn-On Start-Up Time	Delay Measured from V_{INn} Toggling from 0V to 36V to PGOOD n Exceeding 3V; PGOOD n . Having a 100k Ω Pull-Up to 3.3V with Respect to GND, VPGFB n Resistor Divider Network as Shown in Test Circuit 1, $R_{ISETna} = 480\text{k}\Omega$ and ISET na Electrically Connected to ISET nb and CLKIN Driven with 1.5MHz Clock	●	4	9	ms	
$\Delta V_{OUTn(\text{LS})}^+$	Peak Output Voltage Deviation for Dynamic Load Step	I_{OUTn}^+ : 0A to 2A and 2A to 0A Load Steps in 1 μs , $C_{OUTHn} = 47\mu\text{F} \times 2$		400		mV	
$t_{\text{SETTLE}n}$	Settling Time for Dynamic Load Step	I_{OUTn}^+ : 0A to 2A and 2A to 0A Load Steps in 1 μs , $C_{OUTHn} = 47\mu\text{F} \times 2$		50		μs	
$I_{OUTn(\text{OCL})}^+$	I_{OUTn}^+ Output Current Limit			5.5		A	
Control Section							
I_{ISETna}	Reference Current of ISET na Pin	$V_{ISETna} = 0.5\text{V}$, $3.1\text{V} \leq V_{INn} \leq 13.2\text{V}$ $V_{ISETna} = 24\text{V}$, $29\text{V} \leq V_{INn} \leq 40\text{V}$	● ●	49.3 49	50 50	50.7 51	μA μA
I_{VOSNSn}^+	V_{OSNSn}^+ Leakage Current	$V_{VOSNSn}^+ = 28\text{V}$		290		μA	
$t_{\text{ON}n(\text{MIN})}$	Minimum On-Time	(Note 4)		60		ns	
$V_{\text{RUN}n}$	RUN n Turn-On/-Off Thresholds	RUN n Input Turn-On Threshold, RUN n Rising RUN n Hysteresis	●	1.08 130	1.2	1.32	V mV
$I_{\text{RUN}n}$	RUN n Leakage Current	RUN $n = 3.3\text{V}$	●	0.1	50	nA	
Oscillator and Phase-Locked Loop (PLL)							
$f_{\text{OSC}n}$	Oscillator Frequency Accuracy	$V_{INn} = 12\text{V}$, ISET $na = 5\text{V}$, and: $f_{\text{SET}n}$ Open-Circuit $R_{fSETn} = 57.6\text{k}\Omega$ (See f_{SN} Specification)	●	360 400 1.95	440	kHz MHz	
$f_{\text{SYNC}n}$	PLL Synchronization Capture Range	$V_{INn} = 12\text{V}$, ISET $na = 5\text{V}$, CLKIN n Driven with a GND Referred Clock Toggling from 0.4V to 1.2V and Having a Clock Duty Cycle: From 10% to 90%; $f_{\text{SET}n}$ Open Circuit From 40% to 60%; $R_{fSETn} = 57.6\text{k}\Omega$		250 1.3	550 3	kHz MHz	
$V_{\text{CLKIN}n}$	CLKIN n Input Threshold	$V_{\text{CLKIN}n}$ Rising $V_{\text{CLKIN}n}$ Falling		1.2	0.4	V V	
$I_{\text{CLKIN}n}$	CLKIN n Input Current	$V_{\text{CLKIN}n} = 5\text{V}$ $V_{\text{CLKIN}n} = 0\text{V}$		-20 230 -5	500	μA μA	
Power Good Feedback Input and Power Good Output							
$OV_{\text{PGDFB}n}$	Output Overvoltage PGOOD n Upper Threshold	PGDFB n Rising	●	620	645	675	mV
$UV_{\text{PGDFB}n}$	Output Undervoltage PGOOD n Lower Threshold	PGDFB n Falling	●	525	555	580	mV
$\Delta V_{\text{PGDFB}n}$	PGOOD n Hysteresis	PGDFB n Returning			8		mV
$R_{\text{PGDFB}n}$	Resistor Between PGDFB $1n$ and SV_{OUTn}^-			4.94	4.99	5.04	k Ω
$R_{\text{PGOOD}n}$	PGOOD n Pull-Down Resistance	$V_{\text{PGOOD}n} = 0.1\text{V}$, $V_{\text{PGDFB}n} < UV_{\text{PGDFB}n}$ or $V_{\text{PGDFB}n} > OV_{\text{PGDFB}n}$			700	1500	Ω
$I_{\text{PGOOD}n(\text{LEAK})}$	PGOOD n Leakage Current	$V_{\text{PGOOD}n} = 3.3\text{V}$, $UV_{\text{PGDFB}n} < V_{\text{PGDFB}n} < OV_{\text{PGDFB}n}$			0.1	1	μA

ELECTRICAL CHARACTERISTICS The ● denotes the specifications which apply over the specified internal operating temperature range (Note 2). Specified as each individual output channel (Note 5). $T_A = 25^\circ\text{C}$, Test Circuit 1 (positive- V_{OUTn}^+ , noninverting step-down configuration with $V_{OUTn}^- = \text{GND}$), $V_{INn} = \text{SV}_{INn} = 36\text{V}$, $\text{EXTV}_{CCn} = 24\text{V}$, $\text{RUNn} = 3.3\text{V}$, $R_{ISETn} = 480\text{k}\Omega$, $R_{fSETn}^+ = 57.6\text{k}\Omega$, $f_{SWn} = 1.5\text{MHz}$ (CLKINn driven with 1.5MHz clock signal) and voltages referred to GND unless otherwise noted.

SYMBOL	PARAMETER	CONDITIONS	MIN	TYP	MAX	UNITS	
$t_{PGOODn(\text{DELAY})}$	PGOODn Delay	PGOODn Low to High (Note 4) PGOODn High to Low (Note 4)		$16/f_{SW(\text{Hz})}$ $64/f_{SW(\text{Hz})}$		s s	
Current Monitor and Input Voltage Regulation Pins							
h_{IMONna}	I_{OUTn}^+/I_{IMONna}	Ratio of V_{OUTn}^+ Output Current to I_{IMONna} Current, $I_{OUTn}^+ = 4\text{A}$	●	36	40	44	k
$I_{OSn}(\text{IMON})$	I_{IMONna} Offset Current	I_{IMONna} at $I_{OUTn}^+ = 0\text{A}$		-5		5	μA
IMONnb Resistor	Resistor Between IMONnb and SV_{OUTn}^-			9.8	10	10.2	k Ω
V_{IMONna}	IMONna Servo Voltage	IMONna Voltage During Output Current Regulation	●	1.9	2.0	2.1	V
$V_{VINREGn}$	$V_{VINREGn}$ Servo Voltage	VINREGn Voltage During Output Current Regulation	●	1.8	2.0	2.2	V
$I_{VINREGn}$	$V_{VINREGn}$ Leakage Current	$V_{VINREGn} = 2\text{V}$			1		nA
INTV_{CCn} Regulator							
$V_{INTVCCn}$	Channel Internal V_{CC} Voltage, No INTV _{CCn} Loading ($I_{INTVCCn} = 0\text{mA}$)	$3.6\text{V} \leq \text{SV}_{INn} \leq 40\text{V}$, EXTV_{CCn} Open Circuit $5\text{V} \leq \text{SV}_{INn} \leq 40\text{V}$, $3.2\text{V} \leq \text{EXTV}_{CCn} \leq 26.5\text{V}$		3.15 2.85	3.4 3.0	3.65 3.15	V V
$V_{EXTVCCn(\text{TH})}$	EXTV _{CCn} Switchover Voltage	(Note 4)			3.15		V
$\Delta V_{INTVCCn(\text{LOAD})}/V_{INTVCCn}$	INTV _{CCn} Load Regulation	$0\text{mA} \leq I_{INTVCCn} \leq 30\text{mA}$		-2	0.5	2	%

ELECTRICAL CHARACTERISTICS The ● denotes the specifications which apply over the specified internal operating temperature range (Note 2). Specified as each individual output channel (Note 5). $T_A = 25^\circ\text{C}$, Test Circuit 2 (negative- V_{OUTn}^- , inverting buck-boost configuration with $V_{OUTn}^+ = \text{GND}$), $V_{INn} = 12\text{V}$ and electrically connected to SV_{INn} , $\text{RUNn}-\text{GND} = 3.3\text{V}$, $\text{ISETna}-\text{SV}_{OUTn}^- = 24\text{V}$, $\text{EXTV}_{CCn} = \text{GND}$, CLKINn open circuit, $R_{fSETn} = 57.6\text{k}\Omega$ and $R_{ISETn} = 480\text{k}\Omega$ and voltages referred to GND unless otherwise noted.

SYMBOL	PARAMETER	CONDITIONS	MIN	TYP	MAX	UNITS	
$\text{SV}_{INn(\text{DC})}$, $V_{INn(\text{DC})}$	Input DC Voltage in Negative- V_{OUTn}^- Configuration	$V_{INn}^+ V_{OUTn}^- \leq 40\text{V}$	●	3.6		40	V
$V_{OUTn(\text{RANGE})}^-$	Range of Negative Output Voltage Regulation	$0.5\text{V} \leq \text{ISETna}-\text{SV}_{OUTn}^- \leq 26.5\text{V}$	●	-26.5		-0.5	V
$V_{OUTn(-24\text{VDC})}^-$	Output Voltage Total Variation with Line and Load at $V_{OUTn}^- = -24\text{V}$	$3.6\text{V} \leq V_{INn} \leq 16\text{V}$, $0\text{A} \leq I_{OUTn}^- \leq 0.3\text{A}$, CLKINn Driven per Note 8, $C_{INn} = 4.7\mu\text{F}$, $C_{Dn} = 4.7\mu\text{F} \times 2$, $C_{OUTHn} = 47\mu\text{F} \times 2$	●	-24.4	-24	-23.6	V
$V_{OUTn(-5\text{VDC})}^-$	Output Voltage Total Variation with Line and Load at $V_{OUTn}^- = -5\text{V}$	Measuring $V_{OSNSn}^+ - \text{ISETna}$, $12\text{V} \leq V_{INn} \leq 35\text{V}$, $0\text{A} \leq I_{OUTn}^- \leq 3\text{A}$, CLKINn Driven by 550kHz Clock, $C_{INn} = 4.7\mu\text{F}$, $C_{Dn} = 4.7\mu\text{F} \times 2$, $C_{OUTHn} = 47\mu\text{F} \times 2$, $\text{ISETna}-\text{SV}_{OUTn}^- = 5\text{V}$	●	-15	0	15	mV
R_{SVINFn}	Resistor Between SV_{INn} and SV_{INFn}				1		Ω

ELECTRICAL CHARACTERISTICS The ● denotes the specifications which apply over the specified internal operating temperature range (Note 2). Specified as each individual output channel (Note 5). $T_A = 25^\circ\text{C}$, Test Circuit 2 (negative- V_{OUTn^-} , inverting buck-boost configuration with $V_{OUTn^+} = \text{GND}$), $V_{INn} = 12\text{V}$ and electrically connected to SV_{INn} , $\text{RUNn-GND} = 3.3\text{V}$, $\text{ISETna-SV}_{OUTn^-} = 24\text{V}$, $\text{EXTV}_{CCn} = \text{GND}$, CLKINn open circuit, $R_{\text{ISETn}} = 57.6\text{k}\Omega$ and $R_{\text{ISETnb}} = 480\text{k}\Omega$ and voltages referred to GND unless otherwise noted.

SYMBOL	PARAMETER	CONDITIONS	MIN	TYP	MAX	UNITS
Input Specifications						
$V_{INn}(\text{UVLO})$	SV_{INn} Undervoltage Lockout Threshold	SV_{INn} Rising SV_{INn} Falling Hysteresis	● ● ●	2.1 2.5 400	3.2 2.5 700	3.6 2.8 mV
$I_{\text{INRUSH}}(V_{INn})$	Input Inrush Current at Start-Up	$C_{\text{INHn}} = 4.7\mu\text{F}$, $C_{\text{Dn}} = 4.7\mu\text{F} \times 2$, $C_{\text{OUTHn}} = 47\mu\text{F} \times 2$; $I_{\text{OUTn}^-} = 0\text{A}$, ISETna Electrically Connected to ISETnb		1.1		A
$I_{\text{Q}}(SV_{INn})$	Input Supply Bias Current	Shutdown, $\text{RUNn} = \text{GND}$ $\text{RUNn-GND} = 3.3\text{V}$		16 450	30	μA μA
$I_{\text{S}}(V_{INn})$	Input Supply Current	CLKINn Open Circuit, $I_{\text{OUTn}^-} = 1.25\text{A}$		3.0		A
$I_{\text{S}}(V_{INn}, \text{SHUTDOWN})$	Input Supply Current in Shutdown	Shutdown, $\text{RUNn} = \text{GND}$		4		μA
Output Specifications						
I_{OUTn^-}	V_{OUTn^-} Output Continuous Current Range	$V_{INn} = 12\text{V}$, Regulating $V_{\text{OUTn}^-} = -24\text{V}$ at $f_{\text{SWn}} = 1\text{MHz}$ $V_{INn} = 12\text{V}$, Regulating $V_{\text{OUTn}^-} = -5\text{V}$ at $f_{\text{SWn}} = 550\text{kHz}$ (See Note 3. Capable of Up to 4A Output Current for Some Combinations of V_{INn} , V_{OUTn^-} and f_{SWn})		0 0	1.25 3	A A
$\Delta V_{\text{OUTn}(\text{LINE})^-}/V_{\text{OUTn}^-}$	Line Regulation Accuracy	$I_{\text{OUTn}^-} = 0\text{A}$, $3.6\text{V} \leq V_{INn} \leq 16\text{V}$, $\text{ISETna-SV}_{\text{OUTn}^-} = 24\text{V}$, CLKINn Driven by 1.8MHz Clock	●	0.05	0.25	%
$\Delta V_{\text{OUTn}(\text{LOAD})^-}/V_{\text{OUTn}^-}$	Load Regulation Accuracy	$V_{INn} = 12\text{V}$, $0\text{A} \leq I_{\text{OUTn}^-} \leq 1.25\text{A}$, CLKINn Driven by 1.5MHz Clock, $R_{\text{ISETn}} = 57.6\text{k}\Omega$, and $R_{\text{ISETnb}} = 480\text{k}\Omega$	●	0.05	0.75	%
$V_{\text{OUTn}(\text{AC})^-}$	Output Voltage Ripple, V_{OUTn^-}	$V_{INn} = 12\text{V}$, $\text{ISETna-SV}_{\text{OUTn}^-} = 5\text{V}$		10		mV _{p-p}
f_{SN}	V_{OUTn^-} Ripple Frequency	$V_{INn} = 12\text{V}$, $\text{ISETna-SV}_{\text{OUTn}^-} = 5\text{V}$	●	1.7	1.95	2.2
$\Delta V_{\text{OUTn}(\text{START})^-}$	Turn-On Overshoot			8		mV
t_{STARTn}	Turn-On Start-Up Time	Delay Measured from V_{INn} Toggling from 0V to 12V to PGOODn Exceeding 3V Above GND; PGOODn Having a 100k Ω Pull-Up to 3.3V with Respect to GND, V_{PGFBn} Resistor Divider Network as Shown in Test Circuit 2, $R_{\text{ISETna}} = 480\text{k}\Omega$, ISETna Electrically Connected to ISETnb , and CLKINn Driven with 1.2MHz Clock	●	4	9	ms
$\Delta V_{\text{OUTn}(\text{LS})^-}$	Peak Output Voltage Deviation for Dynamic Load Step	I_{OUTn^-} : 0A to 1A and 1A to 0A Load Steps in 1 μs , $C_{\text{OUTHn}} = 47\mu\text{F} \times 2$		400		mV
t_{SETTLEn}	Settling Time for Dynamic Load Step	I_{OUTn^-} : 0A to 1A and 1A to 0A Load Steps in 1 μs , $C_{\text{OUTH2}} = 47\mu\text{F} \times 2 \times 5\text{R}$		50		μs
$I_{\text{OUTn}(\text{OCL})^-}$	I_{OUTn^-} Output Current Limit			1.7		A
Control Section						
I_{ISETna}	Reference Current of ISETna Pin	$V_{\text{ISETna-SV}_{\text{OUTn}^-}} = 0.5\text{V}$, $3.6\text{V} \leq V_{INn} \leq 28\text{V}$ $0\text{V} \leq V_{\text{ISETna-SV}_{\text{OUTn}^-}} \leq V_{INn-SV_{\text{OUTn}^-}} \leq 40\text{V}$	● ●	49.3 49	50 50	50.7 51
I_{VOSNSn^+}	V_{OSNSn^+} Leakage Current	$V_{\text{OSNSn}^+} - SV_{\text{OUTn}^-} = 28\text{V}$		290		μA
$t_{\text{ONn}(\text{MIN})}$	Minimum On-Time	(Note 4)		60		ns
V_{RUNn}	RUNn Turn-On/-Off Thresholds	RUNn Input Turn-On Threshold, RUNn Rising RUNn Hysteresis (RUNn Thresholds Measured with Respect to GND)	●	1.08	1.2 130	1.32 mV
I_{RUNn}	RUNn Leakage Current	$V_{INn} = 12\text{V}$, $\text{RUNn-GND} = 3.3\text{V}$	●	0.1	50	nA

ELECTRICAL CHARACTERISTICS The ● denotes the specifications which apply over the specified internal operating temperature range (Note 2). Specified as each individual output channel (Note 5). $T_A = 25^\circ\text{C}$, Test Circuit 2 (negative- V_{OUTn^-} , inverting buck-boost configuration with $V_{OUTn^+} = \text{GND}$), $V_{INn} = 12\text{V}$ and electrically connected to SV_{INn} , $\text{RUNn-GND} = 3.3\text{V}$, $\text{ISETna-SV}_{OUTn^-} = 24\text{V}$, $\text{EXTV}_{CCn} = \text{GND}$, CLKINn open circuit, $R_{\text{ISETn}} = 57.6\text{k}\Omega$ and $R_{\text{ISETn}} = 480\text{k}\Omega$ and voltages referred to GND unless otherwise noted.

SYMBOL	PARAMETER	CONDITIONS	MIN	TYP	MAX	UNITS
Oscillator and Phase-Locked Loop (PLL)						
f_{OSCn}	Oscillator Frequency Accuracy	$V_{INn} = 12\text{V}$, $\text{ISETna-SV}_{OUTn^-} = 5\text{V}$, and: f_{SETn} Open Circuit $R_{\text{ISETn}} = 57.6\text{k}\Omega$ (See f_{SN} Specification)	● 360	400 1.95	440	kHz MHz
f_{SYNCn}	PLL Synchronization Capture Range	$V_{INn} = 12\text{V}$, $\text{ISETna-SV}_{OUTn^-} = 5\text{V}$, CLKINn Driven with a GND Referred Clock Toggling from 0.4V to 1.2V and Having a Clock Duty Cycle: From 10% to 90%; f_{SETn} Open Circuit From 40% to 60%; $R_{\text{ISETn}} = 57.6\text{k}\Omega$	250 1.3	550 3		kHz MHz
V_{CLKINn}	CLKINn Input Threshold	V_{CLKINn} Rising with Respect to GND V_{CLKINn} Falling with Respect to GND	1.2		0.4	V V
I_{CLKINn}	CLKINn Input Current	$V_{\text{CLKINn}} = 5\text{V}$ with Respect to GND $V_{\text{CLKINn}} = 0\text{V}$ with Respect to GND	-20	230 -5	500	μA μA
Power Good Feedback Input and Power Good Output						
OV_{PGDFBn}	Output Overvoltage PGOODn Upper Threshold	PGDFBn Rising, Differential Voltage from PGDFBn to SV_{OUTn^-}	● 620	645	675	mV
UV_{PGDFBn}	Output Undervoltage PGOODn Lower Threshold	PGDFBn Falling, Differential Voltage from PGDFBn to SV_{OUTn^-}	● 525	555	580	mV
ΔV_{PGDFBn}	PGOODn Hysteresis	PGDFBn Returning		8		mV
R_{PGDFBn}	Resistor Between PGDFBn and SV_{OUTn^-}		4.94	4.99	5.04	$\text{k}\Omega$
R_{PGOODn}	PGOODn Pull-Down Resistance	$V_{\text{PGOODn}} = 0.1\text{V}$ with Respect to GND, $V_{\text{PGDFBn-SV}_{OUTn^-}} < UV_{\text{PGDFBn}}$ or $V_{\text{PGDFBn-SV}_{OUTn^-}} > OV_{\text{PGDFBn}}$		700	1500	Ω
$I_{\text{PGOODn(LEAK)}}$	PGOODn Leakage Current	$V_{\text{PGOODn}} = 3.3\text{V}$ with Respect to GND, $UV_{\text{PGDFBn}} < V_{\text{PGDFBn-SV}_{OUTn^-}} < OV_{\text{PGDFBn}}$		0.1	1	μA
$t_{\text{PGOODn(DELAY)}}$	PGOODn Delay	PGOODn Low to High (Note 4) PGOODn High to Low (Note 4)		$16/f_{\text{SW(Hz)}}$ $64/f_{\text{SW(Hz)}}$		s s
Input Voltage Regulation Pin						
V_{VINREGn}	V_{INREGn} Servo Voltage	V_{INREGn} Voltage During Output Current Regulation, Measured with Respect to SV_{OUTn^-}	● 1.8	2.0	2.2	V
I_{VINREGn}	V_{INREGn} Leakage Current	$V_{\text{INREG-SV}_{OUTn^-}} = 2\text{V}$		1		nA
INTV_{CCn} Regulator						
V_{INTVCCn}	Channel Internal V_{CC} Voltage, No INTV_{CCn} Loading ($I_{\text{INTVCCn}} = 0\text{mA}$)	$3.6\text{V} \leq SV_{\text{INn-SV}_{OUTn^-}} \leq 40\text{V}$, $\text{EXTV}_{\text{CCn}} = \text{Open Circuit}$ $5\text{V} \leq SV_{\text{INn-SV}_{OUTn^-}} \leq 40\text{V}$, $3.2\text{V} \leq \text{EXTV}_{\text{CCn}}$ $V_{\text{OUTn^-}} \leq 26.5\text{V}$ (INTV_{CCn} Measured with Respect to SV_{OUTn^-})	3.15 2.85	3.4 3.0	3.65 3.15	V V V
$V_{\text{EXTVCCn(TH)}}$	EXTV_{CCn} Switchover Voltage	(EXTV_{CCn} Measured with Respect to SV_{OUTn^-}) (Note 4)		3.15		V
$\Delta V_{\text{INTVCCn(LOAD)}/V_{\text{INTVCCn}}}$	INTV_{CCn} Load Regulation	$0\text{mA} \leq I_{\text{INTVCCn}} \leq 30\text{mA}$	-2	0.5	2	%

ELECTRICAL CHARACTERISTICS

The ● denotes the specifications which apply over the specified internal operating temperature range (Note 2). $T_A = 25^\circ\text{C}$, Test Circuit 3 and voltages referred to GND unless otherwise noted.

SYMBOL	PARAMETER	CONDITIONS		MIN	TYP	MAX	UNITS
$V_{LDOIN(DC)}$	LDO Input DC Voltage		●	4.5		40	V
$V_{LDOOUT(DC)}$	LDO Output Voltage	$V_{LDOIN} = 36\text{V}$, $0\text{mA} \leq I_{LDOOUT} \leq 25\text{mA}$ $V_{LDOIN} = 4.5\text{V}$, $0\text{mA} \leq I_{LDOOUT} \leq 20\text{mA}$	● ●	4.8 2.7	5.0 4.1	5.2	V V
$V_{LDOOUT(AC)}$	Output Voltage Ripple				2		mV _{P-P}
$I_{LDOOUT(OCL)}$	Output Current Limit, 5V LDO	$V_{LDOIN} = 36\text{V}$			140		mA
Clock Generator							
Δf_{OUT}	Clock-Generator Frequency Accuracy	$2.7\text{V} \leq V_{LDOOUT} \leq 5.2\text{V}$, $200\text{kHz} \leq f_{OUT} \leq 3\text{MHz}$, MOD Connected to CLKOUT2	●		± 2.5 ± 2.5	± 7.5 ± 3	% %
$R_{CLKSET(RANGE)}$	Frequency Setting Resistor Range	R_{CLKSET} Resistance for Which $-7.5\% \leq \Delta f_{OUT} \leq 7.5\%$, Over $2.7\text{V} \leq V_{LDOOUT} \leq 5.2\text{V}$, MOD Electrically Connected to CLKOUT2	●	33.2		499	k Ω
	Period Variation (Frequency Spreading)	$V_{LDOOUT} = 5\text{V}$, $R_{CLKSET} = 100\text{k}\Omega$, MOD Open Circuit			± 10		%
	Duty Cycle	$2.7\text{V} \leq V_{LDOOUT} \leq 5.2\text{V}$, $200\text{kHz} \leq f_{OUT} \leq 3\text{MHz}$, MOD Electrically Connected to CLKOUT2	●	40		60	%
$\theta_{CLKOUT1}/\theta_{CLKOUT2}$	Phase Relationship of CLKOUT2 to CLKOUT1	$2.7\text{V} \leq V_{LDOOUT} \leq 5.2\text{V}$, $200\text{kHz} \leq f_{OUT} \leq 3\text{MHz}$, MOD Electrically Connected to CLKOUT2			180		Deg
$V_{OH_CLKOUTn}$	CLKOUT n Output Voltage, Logic High	CLKOUT n V_{OH} Measured with Respect to V_{LDOOUT} , $2.7\text{V} \leq V_{LDOOUT} \leq 5.2\text{V}$, $I_{CLKOUTn} = -100\mu\text{A}$		-0.4			V
$V_{OL_CLKOUTn}$	CLKOUT n Output Voltage, Logic Low	CLKOUT n V_{OL} Measured with Respect to GND, $2.7\text{V} \leq V_{LDOOUT} \leq 5.2\text{V}$, $I_{CLKOUTn} = 100\mu\text{A}$				0.4	V
Temperature Sensor							
ΔV_{TEMP}	Temperature Sensor Forward Voltage, V_{TEMP+} to V_{TEMP-}	$I_{TEMP+} = 100\mu\text{A}$ and $I_{TEMP-} = -100\mu\text{A}$ at $T_A = 25^\circ\text{C}$			0.598		V
$TC_{\Delta V(TEMP)}$	ΔV_{TEMP} Temperature Coefficient				-2.0		mV/ $^\circ\text{C}$
η	Ideality Factor				1.004		

Note 1: Stresses beyond those listing under Absolute Maximum Ratings may cause permanent damage to the device. Exposure to any Absolute Maximum Rating conditions for extended periods may affect device reliability and lifetime.

Note 2: The LTM4655 is tested under pulsed load conditions such that $T_J \approx T_A$. The LTM4655E is guaranteed to meet performance specifications over the 0°C to 125°C internal operating temperature range. Specifications over the full -40°C to 125°C internal operating temperature range are assured by design, characterization and correlation with statistical process controls.

The LTM4655I is guaranteed to meet specifications over the full -40°C to 125°C internal operating temperature range. The LTM4655MP is tested and guaranteed over the full -55°C to 125°C operating temperature range. Note that the maximum ambient temperature consistent with these specifications is determined by specific operating conditions in conjunction with board layout, the rated package thermal resistance and other environmental factors.

Note 3: See output current derating curves for different V_{IN} , V_{OUT} , and T_A , located in the Applications Information section.

Note 4: Minimum on-time, PGOOD delay, and EXTV_{CCn} switchover threshold are tested at wafer sort.

Note 5: The two power inputs— V_{IN1} and V_{IN2} —and their respective power outputs— V_{OUT1+} or V_{OUT1-} , and V_{OUT2+} or V_{OUT2-} , depending on operational configuration—are tested independently in production, in both positive- V_{OUT} (noninverting step-down) and negative- V_{OUT} (inverting buck-boost) configurations. On occasion, a shorthand notation is used in this document that allows V_{INn} to refer to both V_{IN1} and V_{IN2} by virtue of n being permitted to take on a value of 1 or 2. This italicized n notation and convention is extended to all such pin names.

Note 6: To ensure minimum on-time criteria is met, V_{OUTn} ($0.5V_{DC}$)⁺ high line regulation is tested at $13.2V_{IN}$, with f_{SETn} and CLKIN n open circuit. V_{OUTn} ($-0.5V_{DC}$)⁻ low line regulation is tested at $3.6V_{IN}$, with f_{SETn} and CLKIN n open circuit.

V_{OUTn} ($-0.5V_{DC}$)⁻ high line regulation is tested at $28V_{IN}$, and with CLKIN n driven at 200kHz —so as to ensure minimum on-time criteria is met. The LTM4655 is not recommended for applications where the minimum on-time criteria (guardband to 90ns) is continuously violated. The LTM4655 can ride through events (such as V_{IN} surge) where the on-time criteria is transiently violated. See the Applications Information section.

Note 7: See the Applications Information section for dropout criteria.

Note 8: V_{OUTn} ($-24V_{DC}$)⁻ is tested at $3.6V_{IN}$ and $16V_{IN}$, with CLKIN n driven with a 1.8MHz clock, I_{SETn} to $SV_{OUTn-} = 12\text{V}$, and $R_{ISET} = 57.6\text{k}$. It is also tested at $12V_{IN}$, with CLKIN n driven with a 1.5MHz clock, $R_{ISETn} = 57.6\text{k}$, and $R_{ISETn} = 480\text{k}$.

Note 9: This IC includes overtemperature protection that is intended to protect the device during momentary overload conditions. Junction temperature will exceed 125°C when overtemperature protection is active. Continuous operation above the specified maximum operating junction temperature may impair device reliability.

Note 10: The INTV_{CCn} Abs Max peak output current is specified as the sum of current drawn by circuits internal to the module biased off of INTV_{CCn} and current drawn by external circuits biased off of INTV_{CCn}. Specified independently, for each channel. See the Applications Information section.

TYPICAL PERFORMANCE CHARACTERISTICS

$T_A = 25^\circ\text{C}$, single channel positive- V_{OUTn}^+ operation only, unless otherwise noted.

Efficiency vs Load Current at 5V_{IN}, Forced Continuous Mode

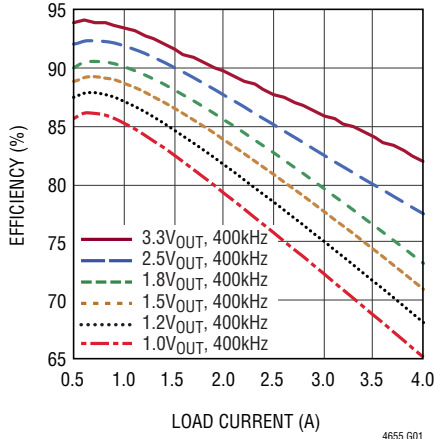

4655 G01

Efficiency vs Load Current at 12V_{IN}, Forced Continuous Mode

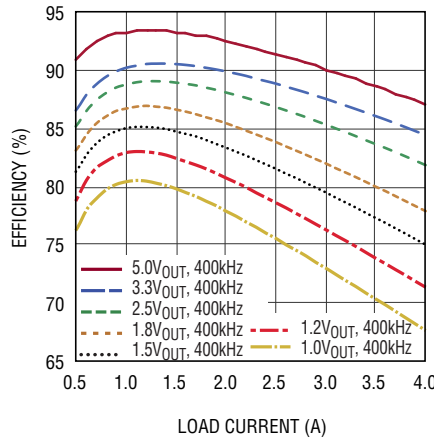

4655 G02

Efficiency vs Load Current at 15V_{IN}, Forced Continuous Mode

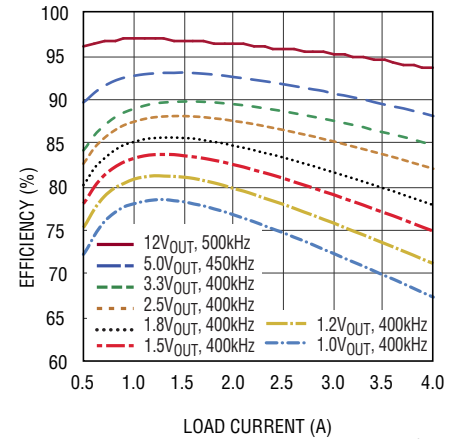

4655 G03

Efficiency vs Load Current at 24V_{IN}, Forced Continuous Mode

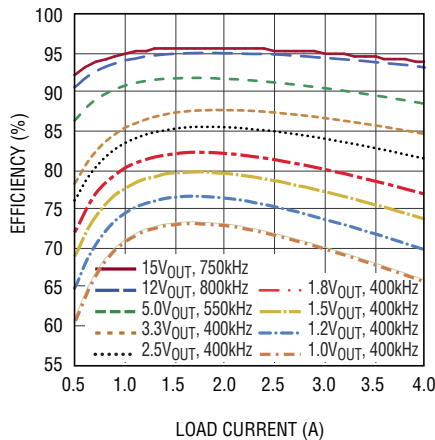

4655 G04

Efficiency vs Load Current at 36V_{IN}, Forced Continuous Mode

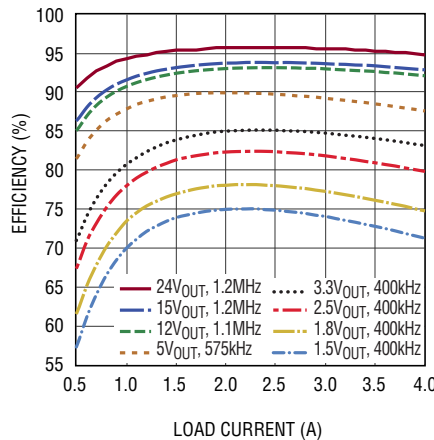

4655 G05

1V Transient Response, 24V_{IN}

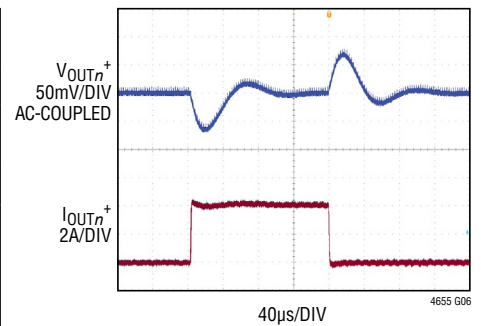

4655 G06

FIGURE 51 CIRCUIT, 24V_{IN},
 $C_{INHn} = C_{DN} = 4.7\mu\text{F}$, $C_{OUTn} = 3 \times 100\mu\text{F}$,
 $R_{ISETn} = \text{N/A}$, $R_{ISETn} = 20\text{k}\Omega$,
 $C_{THn} = 6.8\text{nF}$, $R_{THn} = 681\Omega$,
 $R_{EXTVCCn} = \text{N/A}$, $C_{EXTVCCn} = \text{N/A}$,
 2A to 4A LOAD STEP AT 2A/ μs

TYPICAL PERFORMANCE CHARACTERISTICS

$T_A = 25^\circ\text{C}$, single channel positive- V_{OUTn}^+ operation only, unless otherwise noted.

Start-Up, No Load

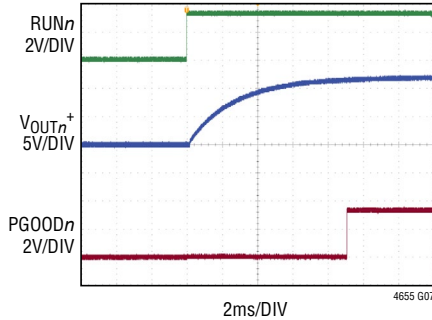

FIGURE 51 CIRCUIT, $36V_{IN}$,
 $C_{INHn} = C_{Dn} = 4.7\mu\text{F}$, $C_{OUTn} = 2 \times 22\mu\text{F}$,
 $R_{fSETn} = 124k$, $R_{iSETn} = 240k\Omega$,
 $R_{PGDFBn} = 95.3k\Omega$,
 $C_{THn} = 10\text{nF}$, $R_{THn} = 562\Omega$,
 $R_{EXTVCCn} = 49.9\Omega$, $C_{EXTVCCn} = 1\mu\text{F}$,
 NO LOAD

Start-Up, 4A Load

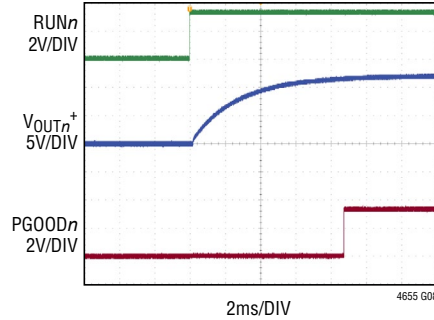

FIGURE 51 CIRCUIT, $36V_{IN}$,
 $C_{INHn} = C_{Dn} = 4.7\mu\text{F}$, $C_{OUTn} = 2 \times 22\mu\text{F}$,
 $R_{fSETn} = 124k$, $R_{iSETn} = 240k\Omega$,
 $R_{PGDFBn} = 95.3k\Omega$,
 $C_{THn} = 10\text{nF}$, $R_{THn} = 562\Omega$,
 $R_{EXTVCCn} = 49.9\Omega$, $C_{EXTVCCn} = 1\mu\text{F}$,
 3Ω RESISTIVE LOAD

Start-Up, Pre-Bias

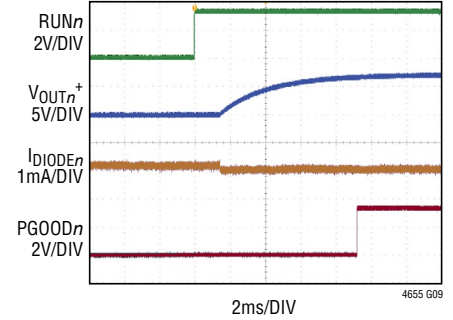

FIGURE 51 CIRCUIT, $36V_{IN}$,
 $C_{INHn} = C_{Dn} = 4.7\mu\text{F}$, $C_{OUTn} = 2 \times 22\mu\text{F}$,
 $R_{fSETn} = 124k$, $R_{iSETn} = 240k\Omega$,
 $R_{PGDFBn} = 95.3k\Omega$,
 $C_{THn} = 10\text{nF}$, $R_{THn} = 562\Omega$,
 $R_{EXTVCCn} = 49.9\Omega$, $C_{EXTVCCn} = 1\mu\text{F}$,
 V_{OUTn}^+ PRE-BIASED TO 5V
 THROUGH 1N4148 DIODE

Short Circuit, No Load

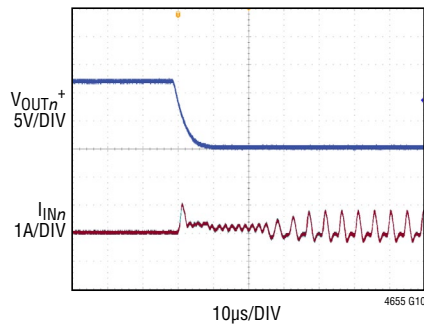

FIGURE 51 CIRCUIT, $36V_{IN}$,
 $C_{INHn} = C_{Dn} = 4.7\mu\text{F}$, $C_{OUTn} = 2 \times 22\mu\text{F}$,
 $R_{fSETn} = 124k$, $R_{iSETn} = 240k\Omega$,
 $R_{PGDFBn} = 95.3k\Omega$,
 $C_{THn} = 10\text{nF}$, $R_{THn} = 562\Omega$,
 $R_{EXTVCCn} = 49.9\Omega$, $C_{EXTVCCn} = 1\mu\text{F}$,
 NO LOAD PRIOR TO APPLICATION
 OF OUTPUT SHORT-CIRCUIT

Short Circuit, 4A Load

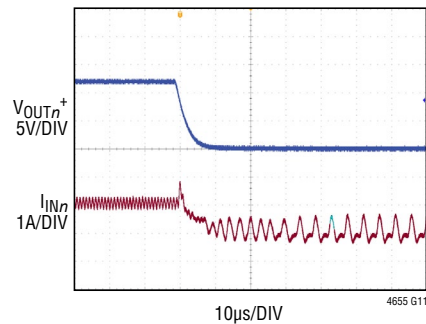
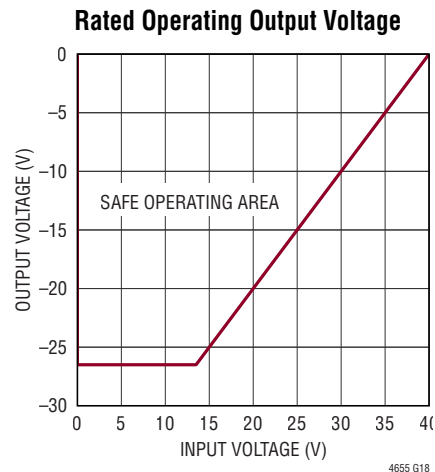
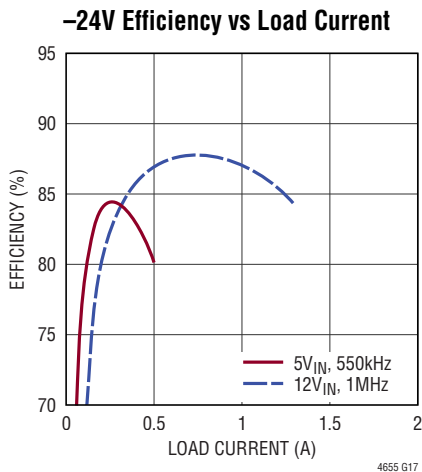
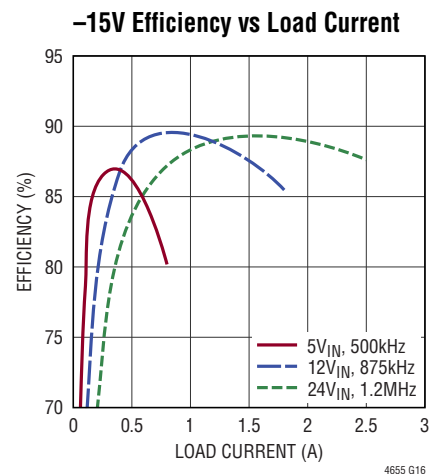
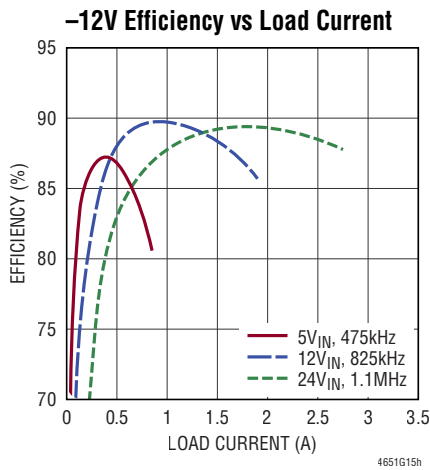
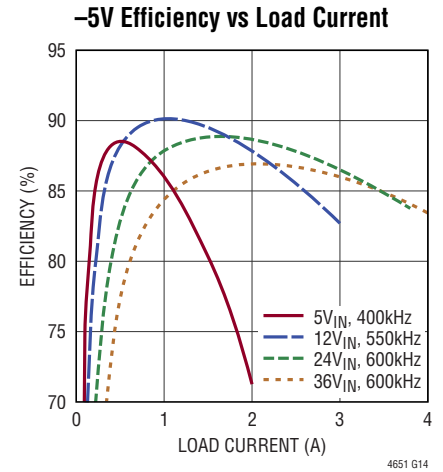
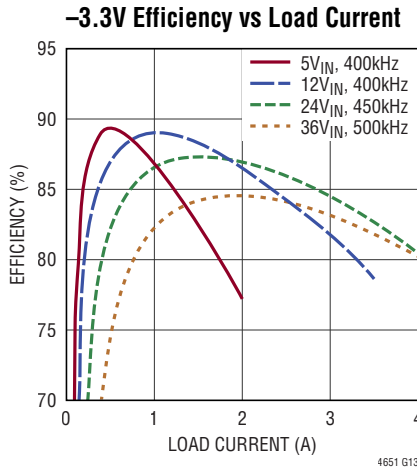
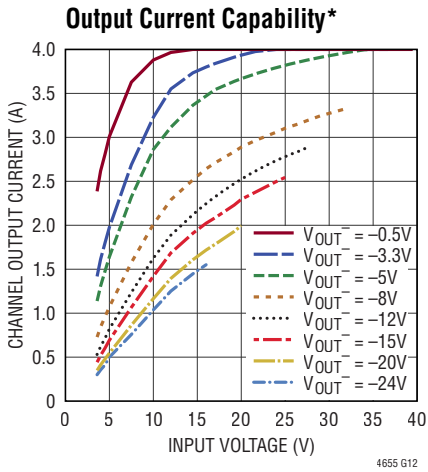

FIGURE 51 CIRCUIT, $36V_{IN}$,
 $C_{INHn} = C_{Dn} = 4.7\mu\text{F}$, $C_{OUTn} = 2 \times 22\mu\text{F}$,
 $R_{fSETn} = 124k$, $R_{iSETn} = 240k\Omega$,
 $R_{PGDFBn} = 95.3k\Omega$,
 $C_{THn} = 10\text{nF}$, $R_{THn} = 562\Omega$,
 $R_{EXTVCCn} = 49.9\Omega$, $C_{EXTVCCn} = 1\mu\text{F}$,
 4Ω RESISTIVE LOAD PRIOR TO
 APPLICATION OF OUTPUT
 SHORT-CIRCUIT

TYPICAL PERFORMANCE CHARACTERISTICS

$T_A = 25^\circ\text{C}$, single channel negative- V_{OUTn} operation only, unless otherwise noted.



*Current limit frequency-foldback activates at load currents higher than indicated curves. Continuous channel output current capability subject to details of application implementation. Switching frequency set per Table 1. See Notes 2 and 3.

TYPICAL PERFORMANCE CHARACTERISTICS

$T_A = 25^\circ\text{C}$, single channel negative- V_{OUTn^-} operation only, unless otherwise noted.

-5V Transient Response, 24V_{IN}

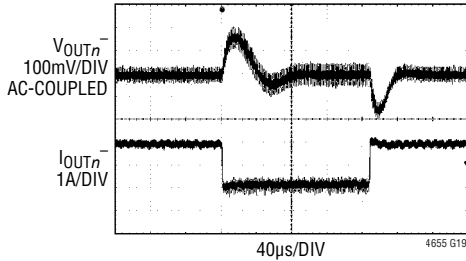

FIGURE 48 CIRCUIT, 24V_{IN}.
 $C_{INOUTn^-} = C_{INHn^-} = C_{DGNDn^-} = C_{Dn^-} = 4.7\mu\text{F}$,
 $C_{OUTn^-} = 47\mu\text{F} \times 2$, $R_{ISETn^-} = 665\text{k}\Omega$,
 $R_{ISETn^-} = 100\text{k}\Omega$, $R_{PGDFBn^-} = 36.5\text{k}\Omega$,
 $R_{EXTVCCn^-} = 20\Omega$, 1.8A TO 3.8A LOAD STEP AT 2A/µs

-24V Transient Response, 12V_{IN}

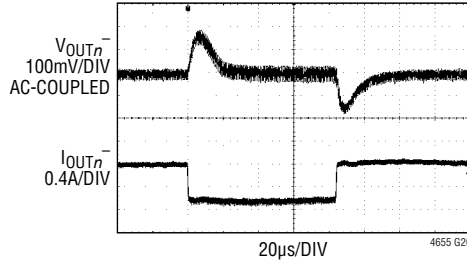

FIGURE 48 CIRCUIT,
 0.625A TO 1.25A LOAD STEP AT 0.625A/µs

Start-Up, No Load

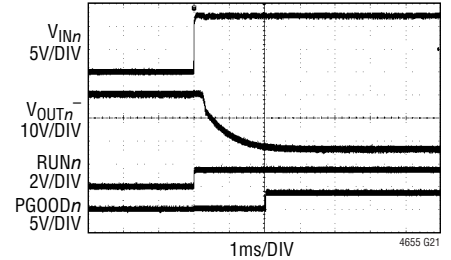

FIGURE 48 CIRCUIT, APPLICATION OF 12V_{IN},
 START-UP INTO NO LOAD

Start-Up, 1.25A Load

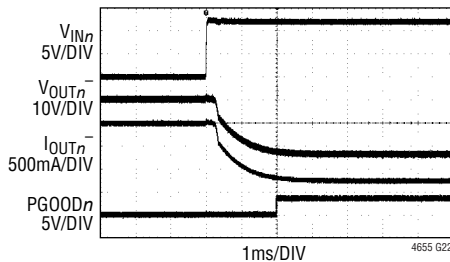

FIGURE 48 CIRCUIT, APPLICATION OF 12V_{IN},
 START-UP INTO 19.2Ω LOAD

Start-Up, Pre-Bias

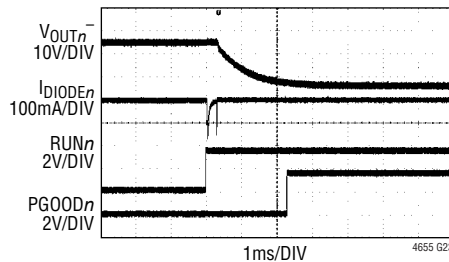

FIGURE 48 CIRCUIT, V_{OUTn^-} PRE-BIASED
 TO -5V THROUGH A 1N4148 DIODE PRIOR
 TO RUN_n TOGGING HIGH

Short Circuit, No Load

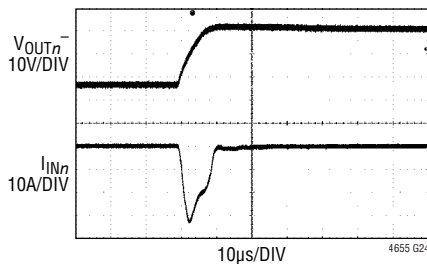

FIGURE 48 CIRCUIT,
 NO LOAD PRIOR TO APPLICATION OF
 V_{OUTn^-} SHORT-CIRCUIT

Short Circuit, 1.25A Load

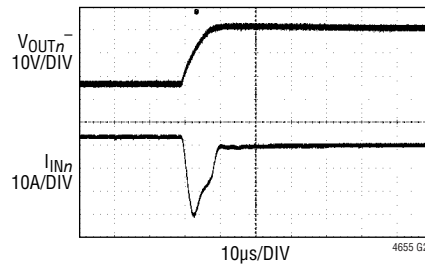

FIGURE 48 CIRCUIT,
 19.2Ω LOAD PRIOR TO APPLICATION OF
 V_{OUTn^-} SHORT-CIRCUIT

PIN FUNCTIONS



PACKAGE ROW AND COLUMN LABELING MAY VARY AMONG μ Module PRODUCTS. REVIEW EACH PACKAGE LAYOUT CAREFULLY.

V_{IN1} (A1–A3, B3): Channel 1 Power Input Pins. Apply input voltage and input decoupling capacitance directly between V_{IN1} and a power ground (PGND) plane. Either connect PGND to V_{OUT1}^- in noninverting step-down applications, where V_{OUT1}^+ is the regulated positive output voltage—or, connect PGND to V_{OUT1}^+ in inverting buck-boost applications, where V_{OUT1}^- is the regulated negative output voltage.

V_{D1} (A4, B4, C4): Drain of Channel 1's Primary Switching MOSFET. Apply at least one 4.7 μ F high frequency ceramic decoupling capacitor directly from V_{D1} to V_{OUT1}^- . Give this capacitor higher layout priority (closer proximity to the module) than any V_{IN1} decoupling capacitors.

V_{OUT1}^- (A5, B5, C5, D5, E5, F5, G4–5, H3, H5, J3–5, K4–5, L4–5, M4–5): Negative Power Output of Channel 1. Either connect V_{OUT1}^- to a PGND plane in noninverting step-down applications, where V_{OUT1}^+ is the regulated positive output voltage—or, connect V_{OUT1}^+ to PGND in inverting buck-boost applications, where V_{OUT1}^- is the regulated negative output voltage.

V_{IN2} (A6–A8, B8): Channel 2 Power Input Pins. Apply input voltage and input decoupling capacitance directly between V_{IN2} and a power ground (PGND) plane. Either connect PGND to V_{OUT2}^- in noninverting step-down applications, where V_{OUT2}^+ is the regulated positive output voltage—or, connect PGND to V_{OUT2}^+ in inverting buck-boost applications, where V_{OUT2}^- is the regulated negative output voltage.

V_{D2} (A9, B9, C9): Drain of Channel 2's Primary Switching MOSFET. Apply at least one 4.7 μ F high frequency ceramic decoupling capacitor directly from V_{D2} to V_{OUT2}^- . Give this capacitor higher layout priority (closer proximity to the module) than any V_{IN2} decoupling capacitors.

V_{OUT2}^- (A10–12, B10, C10, D10–11, E10–11, F10–11, G9–11, H8, H10–12, J8–10, K9–12, L9–12, M9–12): Negative Power Output of Channel 2. Either connect V_{OUT2}^- to a PGND plane in noninverting step-down applications, where V_{OUT2}^+ is the regulated positive output voltage—or, connect V_{OUT2}^+ to PGND in inverting

buck-boost applications, where V_{OUT2}^- is the regulated negative output voltage.

CLKIN1 (B1): Channel 1 Mode Select and Oscillator Synchronization Input. Referred to GND. Leave CLKIN1 open circuit for forced continuous mode operation.

Alternatively, this pin can be driven so as to synchronize the switching frequency of channel 1 to a clock signal. In this condition, channel 1 operates in forced continuous mode and the cycle-by-cycle turn-on of its primary MOSFET is coincident with the rising edge of the clock applied to CLKIN1. Note the synchronization range of CLKIN1 is approximately $\pm 40\%$ of the oscillator frequency programmed by the f_{SET1} pin. (See the Applications Information section.) The LTM4655 contains a built-in dual 180° out-of-phase clock generator. Electrically connect CLKIN1 to CLKOUT1 with a short trace, if desired, to synchronize the switching frequency of channel 1 to CLKOUT1. If 0° phase interleaving is desired, connect CLKOUT1 to both CLKIN1 and CLKIN2.

CLKOUT1 (B2): Squarewave Output of Clock Generator for Channel 1. 180° out-of-phase from CLKOUT2. Minimize stray capacitance to this pin. Connect CLKOUT1 to CLKIN1, if desired, to synchronize channel 1 to CLKOUT1. If 0° phase interleaving is desired, connect CLKOUT1 to both CLKIN1 and CLKIN2.

CLKIN2 (B6): Channel 2 Mode Select and Oscillator Synchronization Input. Referred to GND. Leave CLKIN2 open circuit for forced continuous mode operation.

Alternatively, this pin can be driven so as to synchronize the switching frequency of channel 2 to a clock signal. In this condition, channel 2 operates in forced continuous mode and the cycle-by-cycle turn-on of its primary MOSFET is coincident with the rising edge of the clock applied to CLKIN2. Note the synchronization range of CLKIN2 is approximately $\pm 40\%$ of the oscillator frequency programmed by the f_{SET2} pin. (See the Applications Information section.) The LTM4655 contains a built-in dual 180° out-of-phase clock generator. Electrically connect CLKIN2 to CLKOUT2 with a short trace, if desired, to synchronize the switching frequency of channel 2 to CLKOUT2. If 0° phase interleaving is desired, connect CLKOUT1 to both CLKIN1 and CLKIN2.

PIN FUNCTIONS

CLKOUT2 (B7, C12): Squarewave Output of Clock Generator for Channel 2. 180° out-of-phase from CLKOUT1. Minimize stray capacitance to these pins. Connect CLKOUT2 (pin B7, only) to CLKIN2, if desired, to synchronize channel 2 to CLKOUT2. If 0° phase interleaving is desired, connect CLKOUT1 to both CLKIN1 and CLKIN2.

To disable spread spectrum frequency modulation (SSFM), connect CLKOUT2 (pin C12, only) to the MOD pin (pin E12) with a short trace.

The CLKOUT2 pins at locations B7 and C12 are electrically connected together by a signal trace internal to the module. It is pinned out as described purely to facilitate routing of short traces to CLKIN2 and MOD. CLKOUT2 should be routed with minimal trace lengths. Minimize stray capacitance to these pins.

SV_{INF1} (B11): Channel 1 Filtered Voltage Supply for Small Signal Circuits. If powering the LTM4655's 5V LDO from channel 1's supply for small signal circuits, electrically connect SV_{INF1} and LDO_{IN} with a short trace capable of carrying up to 25mA.

LDO_{IN} (B12): Input to 5V LDO. Connect LDO_{IN} to either SV_{INF1} or SV_{INF2} with a short trace capable of carrying up to 25mA, depending on which input rail is better suited for powering the 5V LDO. If LDO_{IN} is being powered from SV_{INF1} or SV_{INF2}, no bypass capacitance from LDO_{IN} to GND is needed; otherwise, 0.1μF-to-1μF local bypass capacitance is recommended.

IMON1b (C1): Channel 1 Power Inductor Analog Indicator Current Default Termination R-C Network. A 10k resistor in parallel with a 10nF capacitor and terminating to SV_{OUT1}⁻ connect to this pin. Connect IMON1b to IMON1a to achieve default power inductor analog indicator current characteristics: 1V (with respect to SV_{OUT1}⁻) at full-scale (4A) load current in positive-V_{OUT}, noninverting step-down applications. (See IMON1a.) If unused, IMON1b can be left open circuit or connected to SV_{OUT1}⁻.

IMON1a (C2): Channel 1 Power Inductor Current Analog Indicator Pin and Current Limit Programming Pin. In positive-V_{OUT} step-down applications, only, the current

flowing out of this pin is equal to 1/40,000 of the average channel 1 power inductor current. Optionally apply a parallel resistor-capacitor network to this pin and terminate it to SV_{OUT1}⁻ in order to construct a voltage (V_{IMON1a}-SV_{OUT1}⁻) that is proportional to channel 1's power inductor current.

IMON1a can be connected to IMON1b if the default resistor capacitor termination network provided by IMON1b is desired. If this analog indicator feature is not desired—or, in negative-V_{OUT}⁻ buck-boost applications: connect IMON1a to SV_{OUT1}⁻.

If IMON1a-SV_{OUT1}⁻ exceeds a trip threshold of approximately 2V, an IMON1 control loop servos channel 1 power inductor current accordingly and thus regulates IMON1a-SV_{OUT1}⁻ at 2V. In this manner, the current limit inception threshold of channel 1 can be configured. (See the Applications Information section.)

SV_{IN1} (C3): Channel 1 Input Voltage Supplies for Small Signal Circuits. SV_{IN1} is the input to the INTV_{CC1} LDO. Connect SV_{IN1} directly to V_{IN1}.

IMON2b (C6): Channel 2 Power Inductor Analog Indicator Current Default Termination R-C Network. A 10k resistor in parallel with a 10nF capacitor and terminating to SV_{OUT2}⁻ connect to this pin. Connect IMON2b to IMON2a to achieve default power inductor analog indicator current characteristics: 1V (with respect to SV_{OUT2}⁻) at full-scale (4A) load current in positive-V_{OUT}, noninverting step-down applications. (See IMON2a.) If unused, IMON2b can be left open circuit or connected to SV_{OUT2}⁻.

IMON2a (C7): Channel 2 Power Inductor Current Analog Indicator Pin and Current Limit Programming Pin. In positive-V_{OUT} step-down applications, only, the current flowing out of this pin is equal to 1/40,000 of the average channel 2 power inductor current. Optionally apply a parallel resistor-capacitor network to this pin and terminate it to SV_{OUT2}⁻ in order to construct a voltage (V_{IMON2a}-SV_{OUT2}⁻) that is proportional to channel 2's power inductor current.

IMON2a can be connected to IMON2b if the default resistor capacitor termination network provided by IMON2b is

PIN FUNCTIONS

desired. If this analog indicator feature is not desired—or, in negative- V_{OUT}^- buck-boost applications: connect IMON2a to SV_{OUT2}^- .

If $IMON2a-SV_{OUT2}^-$ exceeds a trip threshold of approximately 2V, an IMON2 control loop servos channel 2 power inductor current accordingly and thus regulates $IMON2a-SV_{OUT2}^-$ at 2V. In this manner, the current limit inception threshold of channel 2 can be configured. (See the Applications Information section.)

SV_{IN2} (C8): Channel 2 Input Voltage Supplies for Small Signal Circuits. SV_{IN2} is the input to the $INTV_{CC2}$ LDO. Connect SV_{IN2} directly to V_{IN2} .

SV_{INF2} (C11): Channel 2 Filtered Voltage Supply for Small Signal Circuits. If powering the LTM4655's 5V LDO from channel 2's supply for small signal circuits, electrically connect SV_{INF2} and LDO_{IN} with a short trace capable of carrying up to 25mA.

PGOOD1 (D1): Channel 1 Power Good Indicator, Open-Drain Output Pin. PGOOD1 is high impedance when $PGDFB1-SV_{OUT1}^-$ is within approximately $\pm 7.5\%$ of 0.6V. PGOOD1 is pulled to GND when $PGDFB1$ is outside this range.

PGDFB1 (D2): Channel 1 Power Good Feedback Programming Pin. Connect $PGDFB1$ to V_{OSNS1}^+ through a resistor, R_{PGDFB1} . R_{PGDFB1} configures the voltage threshold of $(V_{OUT1}^+ - V_{OUT1}^-)$ for which PGOOD1 toggles its state. If the PGOOD1 feature is used, set R_{PGDFB1} to:

$$R_{PGDFB1} = \left[\frac{V_{OUT1}^+ - V_{OUT1}^-}{0.6V} - 1 \right] \cdot 4.99k \quad (1)$$

Otherwise, leave $PGDFB1$ open circuit.

A small filter capacitor (220pF) internal to the LTM4655 on this pin provides high frequency noise immunity for the PGOOD1 output indicator.

VINREG1 (D3): Channel 1 Input Voltage Regulation Programming Pin. Optionally connect this pin to the midpoint node formed by a resistor divider between V_{D1} and V_{OUT1}^- . If $VINREG1-SV_{OUT1}^-$ falls below approximately 2V, a $VINREG1$ control loop servos the power

inductor current accordingly and thus regulates $VINREG1$ at 2V with respect to SV_{OUT1}^- . (See the Applications Information section.)

If this input voltage regulation feature is not desired on channel 1, connect $VINREG1$ to $INTV_{CC1}$.

GND (D4, D9, D12): Ground Pins. The logic thresholds for $RUNn$, $PGOODn$, and $CLKINn$ are electrically referred to GND. GND is also the reference voltage for the 5V-fixed LDO and the $CLKOUTn$ clock generator. Connect all GND pins to a solid ground plane, PGND.

PGOOD2 (D6): Channel 2 Power Good Indicator, Open-Drain Output Pin. PGOOD2 is high impedance when $PGDFB2-SV_{OUT2}^-$ is within approximately $\pm 7.5\%$ of 0.6V. PGOOD2 is pulled to GND when $PGDFB2$ is outside this range.

PGDFB2 (D7): Channel 2 Power Good Feedback Programming Pin. Connect $PGDFB2$ to V_{OSNS2}^+ through a resistor, R_{PGDFB2} . R_{PGDFB2} configures the voltage threshold of $(V_{OUT2}^+ - V_{OUT2}^-)$ for which PGOOD2 toggles its state. If the PGOOD2 feature is used, set R_{PGDFB2} according to Equation 2.

$$R_{PGDFB2} = \left[\frac{V_{OUT2}^+ - V_{OUT2}^-}{0.6V} - 1 \right] \cdot 4.99k \quad (2)$$

Otherwise, leave $PGDFB2$ open circuit.

A small filter capacitor (220pF) internal to the LTM4655 on this pin provides high frequency noise immunity for the PGOOD2 output indicator.

VINREG2 (D8): Channel 2 Input Voltage Regulation Programming Pin. Optionally connect this pin to the midpoint node formed by a resistor divider between V_{D2} and V_{OUT2}^- . If $VINREG2-SV_{OUT2}^-$ falls below approximately 2V, a $VINREG2$ control loop servos the power inductor current accordingly and thus regulates $VINREG2$ at 2V with respect to SV_{OUT2}^- . (See the Applications Information section.)

If this input voltage regulation feature is not desired on channel 2, connect $VINREG2$ to $INTV_{CC2}$.

PIN FUNCTIONS

COMP1b (E1): Channel 1 Internal Loop Compensation Network. For a majority of applications, the internal, default loop compensation of the LTM4655 is suitable to apply “as is”, and yields very satisfactory results: apply the default loop compensation to channel 1’s control loop by simply connecting COMP1a to COMP1b. When more specialized applications require a personal touch to the optimization of control loop response, this can be easily accomplished by connecting a series resistor-capacitor network from COMP1a to SV_{OUT1}^- and leaving COMP1b open circuit.

COMP1a (E2): Current Control Threshold and Error Amplifier Compensation Node for Channel 1. The trip threshold of channel 1’s current comparator increases with a respective rise in COMP1a voltage. A small filter cap (10pF) internal to the LTM4655 on this pin introduces a high frequency roll-off of the error amplifier response, yielding good noise rejection in the control loop. Often, COMP1a is electrically connected to COMP1b in one’s application, thus applying default loop compensation. Loop compensation (a series resistor capacitor) can be applied externally from COMP1a to SV_{OUT1}^- , if desired or needed, instead. (See COMP1b.)

f_{SET1} (E3): Channel 1 Oscillator Frequency Programming Pin. The default switching frequency of channel 1 is 400kHz. If needed, the programmed frequency can be increased by connecting a resistor between f_{SET1} and SV_{OUT1}^- . Keep f_{SET1}-related trace lengths short. (See the Applications Information section.) Note the synchronization range of CLKIN1 is approximately ±40% of the oscillator frequency programmed by this f_{SET1} pin.

SV_{OUT1}⁻ (E4, G2, H2): Signal Return of Channel 1. The SV_{OUT1}^- pins are the reference node for channel 1’s control loop. A small island of SV_{OUT1}^- copper should be extended from the module and used to shield sensitive channel 1 pins and signals from noise—such as those routing to f_{SET1}, ISET1a/b, and COMP1a/b. All SV_{OUT1}^- pins are connected to each other internal to the module. Connect Pin H2 to V_{OUT1}^- directly under the LTM4655. The remaining SV_{OUT1}^- pins can be used for redundant connectivity or routed to an ICT test point for design-for-test considerations, as desired. See the Applications Information section for the layout checklist.

COMP2b (E6): Channel 2 Internal Loop Compensation Network. For a majority of applications, the internal, default loop compensation of the LTM4655 is suitable to apply “as is”, and yields very satisfactory results: apply the default loop compensation to channel 2’s control loop by simply connecting COMP2a to COMP2b. When more specialized applications require a personal touch to the optimization of control loop response, this can be easily accomplished by connecting a series resistor-capacitor network from COMP2a to SV_{OUT2}^- and leaving COMP2b open circuit.

COMP2a (E7): Current Control Threshold and Error Amplifier Compensation Node for Channel 2. The trip threshold of channel 2’s current comparator increases with a respective rise in COMP2a voltage. A small filter cap (10pF) internal to the LTM4655 on this pin introduces a high frequency roll-off of the error amplifier response, yielding good noise rejection in the control loop. Often, COMP2a is electrically connected to COMP2b in one’s application, thus applying default loop compensation. Loop compensation (a series resistor capacitor) can be applied externally from COMP2a to SV_{OUT2}^- , if desired or needed, instead. (See COMP2b.)

f_{SET2} (E8): Channel 2 Oscillator Frequency Programming Pin. The default switching frequency of channel 2 is 400kHz. If needed, the programmed frequency can be increased by connecting a resistor between f_{SET2} and SV_{OUT2}^- . Keep f_{SET2}-related trace lengths short. (See the Applications Information section.) Note the synchronization range of CLKIN2 is approximately ±40% of the oscillator frequency programmed by this f_{SET2} pin.

SV_{OUT2}⁻ (E9, G7, H7): Signal Return of Channel 2. The SV_{OUT2}^- pins are the reference node for channel 2’s control loop. A small island of SV_{OUT2}^- copper should be extended from the module and used to shield sensitive channel 2 pins and signals from noise—such as those routing to f_{SET2}, ISET2a/b, and COMP2a/b. All SV_{OUT2}^- pins are connected to each other internal to the module. Connect Pin H7 to V_{OUT2}^- directly under the LTM4655. The remaining SV_{OUT2}^- pins can be used for redundant connectivity or routed to an ICT test point for design-for-test considerations, as desired. See the Applications Information section for the layout checklist.

PIN FUNCTIONS

MOD (E12): Modulation Setting Input. This three-state input selects among four modulation rate settings. The MOD pin should be tied to GND for the $f_{OUT}/16$ modulation rate. Leaving the MOD pin open circuit selects the $f_{OUT}/32$ modulation rate. The MOD pin should be electrically connected to LDO_{OUT} for the $f_{OUT}/64$ modulation rate. Electrically connecting CLKOUT2 (pin C12, only) to the MOD pin (pin E12) turns the modulation off. Do not route high speed digital logic or signals with fast edges near MOD. Be advised that the $f_{OUT}/16$, $f_{OUT}/32$ and $f_{OUT}/64$ modulation rates are not explicitly tested in factory ATE to demonstrate their stated typical modulation rates; the **modulation off** setting, however, is.

ISET1b (F1): 1.5nF Soft-Start Capacitor for Channel 1. Connect ISET1b to ISET1a to achieve default soft-start characteristics on channel 1, if desired. See ISET1a.

ISET1a (F2): Accurate 50 μ A Current Source. Positive input to the error amplifier of channel 1. Connect a resistor $R_{ISET1a} = ((V_{OUT1}^+ - V_{OUT1}^-)/50\mu A)$ from this pin to SV_{OUT1}^- local to the module to program the desired channel 1 output voltage magnitude, $V_{OUT1}^+ - V_{OUT1}^-$. A capacitor can be connected from ISET1a to SV_{OUT1}^- to soft-start channel 1's output voltage, i.e., reduce its start-up inrush current. Connect ISET1a to ISET1b in order to achieve default soft-start characteristics if desired. (See ISET1b.)

EXTV_{CC1} (F3): External Bias, Auxiliary Input to the INTV_{CC1} Regulator. When $EXTV_{CC1} - V_{OUT1}^- > 3.2V$ and $SV_{IN1} > 5V$ and $RUN1 - GND > 1.2V$, the INTV_{CC1} LDO derives power from EXTV_{CC1} bias instead of SV_{IN1} . This technique reduces LDO losses considerably, resulting in a corresponding reduction in module junction temperature. For applications in which $4V < V_{OUT1}^+ - V_{OUT1}^- < 28V$, connect EXTV_{CC1} to V_{OUT1}^+ through a $15\Omega \sim 110\Omega$ resistor and locally decouple EXTV_{CC1} to V_{OUT1}^- with a $1\mu F$ ceramic capacitor. Otherwise, connect EXTV_{CC1} to V_{OUT1}^- or leave EXTV_{CC1} open circuit. See the Applications Information section.

RUN1 (F4): Channel 1 Run Control Pin. A voltage above $\sim 1.2V$ (with respect to GND) commands the module to regulate its output voltage. Undervoltage lockout (UVLO) can be implemented by connecting RUN1 to the midpoint

node formed by a resistor divider between V_{IN1} and GND. RUN1 features $\sim 130mV$ of hysteresis.

ISET2b (F6): 1.5nF Soft-Start Capacitor for Channel 2. Connect ISET2b to ISET2a to achieve default soft-start characteristics on channel 2, if desired. See ISET2a.

In addition, the channel 1 output of the LTM4655 can track a voltage applied to this pin. (See the Applications Information section.)

ISET2a (F7): Accurate 50 μ A Current Source. Positive input to the error amplifier of channel 1. Connect a resistor $R_{ISET2a} = ((V_{OUT2}^+ - V_{OUT2}^-)/50\mu A)$ from this pin to SV_{OUT2}^- local to the module to program the desired channel 2 output voltage magnitude, $V_{OUT2}^+ - V_{OUT2}^-$. A capacitor can be connected from ISET2a to SV_{OUT2}^- to soft-start channel 2's output voltage, i.e., reduce its start-up inrush current. Connect ISET2a to ISET2b in order to achieve default soft-start characteristics if desired. (See ISET2b.)

In addition, the channel 2 output of the LTM4655 can track a voltage applied to this pin. (See the Applications Information section.)

EXTV_{CC2} (F8): External Bias, Auxiliary Input to the INTV_{CC2} Regulator. When $EXTV_{CC2} - V_{OUT2}^- > 3.2V$ and $SV_{IN2} > 5V$ and $RUN2 - GND > 1.2V$, the INTV_{CC2} LDO derives power from EXTV_{CC2} bias instead of SV_{IN2} . This technique reduces LDO losses considerably, resulting in a corresponding reduction in module junction temperature. For applications in which $4V < V_{OUT2}^+ - V_{OUT2}^- < 28V$, connect EXTV_{CC2} to V_{OUT2}^+ through a $15\Omega \sim 110\Omega$ resistor and locally decouple EXTV_{CC2} to V_{OUT2}^- with a $1\mu F$ ceramic capacitor. Otherwise, connect EXTV_{CC2} to V_{OUT2}^- or leave EXTV_{CC2} open circuit. See the Applications Information section.

RUN2 (F9): Channel 2 Run Control Pin. A voltage above $\sim 1.2V$ (with respect to GND) commands the module to regulate its output voltage. Undervoltage lockout (UVLO) can be implemented by connecting RUN2 to the midpoint node formed by a resistor divider between V_{IN2} and GND. RUN2 features $\sim 130mV$ of hysteresis.

PIN FUNCTIONS

CLKSET (F12): Clock Generator Frequency Setting Resistor Input. Apply a resistor, R_{CLKSET} , between LDO_{OUT} and CLKSET. The clock frequency of CLKOUT1 and CLKOUT2 is set by R_{CLKSET} , according Equation 3.

$$f_{(CLKOUT1, CLKOUT2)} = 10MHz \cdot \frac{10k\Omega}{R_{CLKSET}(k\Omega)} \quad (3)$$

Resistor values between 32.2k and 499k are supported, corresponding to oscillator frequency settings of 3MHz to 200kHz, respectively. Minimize stray capacitance to this pin.

V_{OSNS1}^+ (G1, H1): Positive Voltage Sense Input for Channel 1. Route a signal trace from V_{OSNS1}^+ to V_{OUT1}^+ at channel 1's point-of-load (POL). This provides the feedback signal to channel 1's control loop. In noisy environments, shield V_{OSNS1}^+ from electrical noise by sandwiching the trace between PGND copper. Pins G1 and H1 are electrically connected to each other internal to the module, and thus it is only necessary to connect one V_{OSNS1}^+ pin to V_{OUT1}^+ at the POL. The remaining V_{OSNS1}^+ pin can be used for redundant connectivity or routed to an ICT test point for design-for-test considerations, as desired.

INTV_{CC1} (G3): Channel 1 Internal Regulator, 3.3V Output with Respect to V_{OUT1}^- . Channel 1 internal control circuits and MOSFET drivers derive power from INTV_{CC1} bias. Leave INTV_{CC1} open circuit. An LDO generates INTV_{CC1} from either SV_{IN1} or EXTV_{CC1}, when RUN1 is logic high ($RUN1-GND > 1.2V$). The INTV_{CC1} LDO is turned off when RUN1 is logic low ($RUN1-GND < 1.2V$). (See EXTV_{CC1}.)

V_{OSNS2}^+ (G6, H6): Positive Voltage Sense Input for Channel 2. Route a signal trace from V_{OSNS2}^+ to V_{OUT2}^+ at channel 2's point-of-load (POL). This provides the feedback signal to channel 2's control loop. In noisy environments, shield V_{OSNS2}^+ from electrical noise by sandwiching the trace between PGND copper. Pins G6 and H6 are electrically connected to each other internal to the module, and thus it is only necessary to connect one V_{OSNS2}^+ pin to V_{OUT2}^+ at the POL. The remaining V_{OSNS2}^+ pin can be used for redundant connectivity or routed to an ICT test point for design-for-test considerations, as desired.

INTV_{CC2} (G8): Channel 2 Internal Regulator, 3.3V Output with Respect to V_{OUT2}^- . Channel 2 internal control circuits and MOSFET drivers derive power from INTV_{CC2} bias. Leave INTV_{CC2} open circuit. An LDO generates INTV_{CC2} from either SV_{IN2} or EXTV_{CC2}, when RUN2 is logic high ($RUN2-GND > 1.2V$). The INTV_{CC2} LDO is turned off when RUN2 is logic low ($RUN2-GND < 1.2V$). (See EXTV_{CC2}.)

LDO_{OUT} (G12): Output of the LTM4655's GND Referenced 5V-Fixed LDO. No bypass capacitance is needed. Powers the clock generator internal to the LTM4655. Can deliver up to 25mA of current.

SW1 (H4): Switching Node of Channel 1 Switching Converter Stage. Used for test purposes. May be routed a short distance with a thin trace to a local test point to monitor switching action of the converter, if desired, but do not route near any sensitive signals; otherwise, leave electrically open circuit.

SW2 (H9): Switching Node of Channel 2 Switching Converter Stage. Used for test purposes. May be routed a short distance with a thin trace to a local test point to monitor switching action of the converter, if desired, but do not route near any sensitive signals; otherwise, leave electrically open circuit.

NC (J1–2, J11–12): No Connect Pins, i.e., Pins with No Internal Connection. The NC pins predominantly serve to provide improved mounting of the module to the board. For drop-in compatibility of the LTM4651/LTM4653 into either half of a LTM4655 layout, these NC are recommended to be left electrically open circuit.

TEMP⁺ (J6): Temperature Sensor, Positive Input. Emitter of a 2N3906-genre PNP bipolar junction transistor (BJT). Optionally interface to temperature monitoring circuitry such as LTC[®]2997, LTC2990, LTC2974 or LTC2975. Otherwise leave electrically open.

TEMP⁻ (J7): Temperature Sensor, Negative Input. Collector and base of a 2N3906-genre PNP bipolar junction transistor (BJT). Optionally interface to temperature monitoring circuitry such as LTC2997, LTC2990, LTC2974 or LTC2975. Otherwise leave electrically open.

PIN FUNCTIONS

V_{OUT1}^+ (K1–3, L1–3, M1–3): Positive Power Output of Channel 1. Bypass V_{OUT1}^+ to V_{OUT1}^- local to the module with at least 1 μ F. The remainder of V_{OUT1}^+ to V_{OUT1}^- bypass caps should be located near channel 1's load. Either connect V_{OUT1}^+ to a PGND plane in inverting buck-boost applications, where V_{OUT1}^- is the regulated negative output voltage—or, connect V_{OUT1}^- to a PGND plane noninverting step-down applications, where V_{OUT1}^+ is the regulated positive output voltage.

V_{OUT2}^+ (K6–8, L6–8, M6–8): Positive Power Output of Channel 2. Bypass V_{OUT2}^+ to V_{OUT2}^- local to the module with at least 1 μ F. The remainder of V_{OUT2}^+ to V_{OUT2}^- bypass caps should be located near channel 2's load. Either connect V_{OUT2}^+ to a PGND plane in inverting buck-boost applications, where V_{OUT2}^- is the regulated negative output voltage—or, connect V_{OUT2}^- to a PGND plane noninverting step-down applications, where V_{OUT2}^+ is the regulated positive output voltage.

TEST CIRCUIT

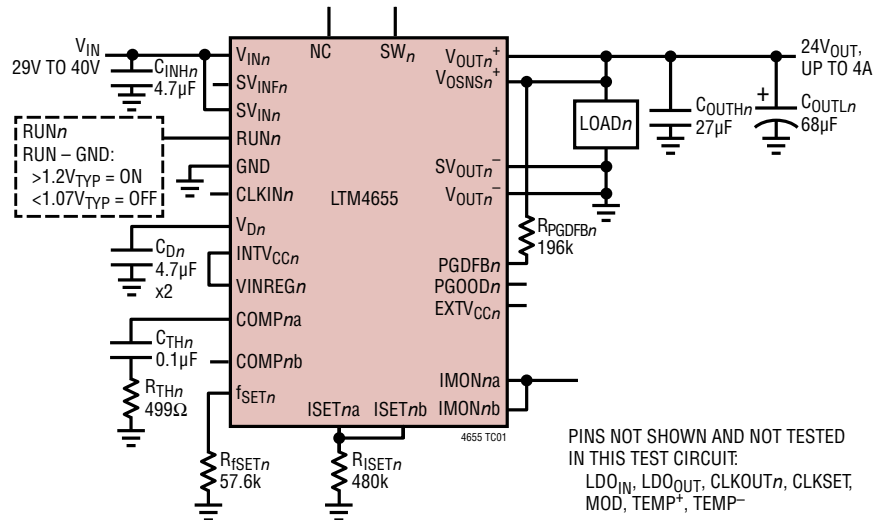

Test Circuit 1. Positive- V_{OUT} Configuration, Regulating V_{OUTn+} , One Channel Shown

TEST CIRCUIT

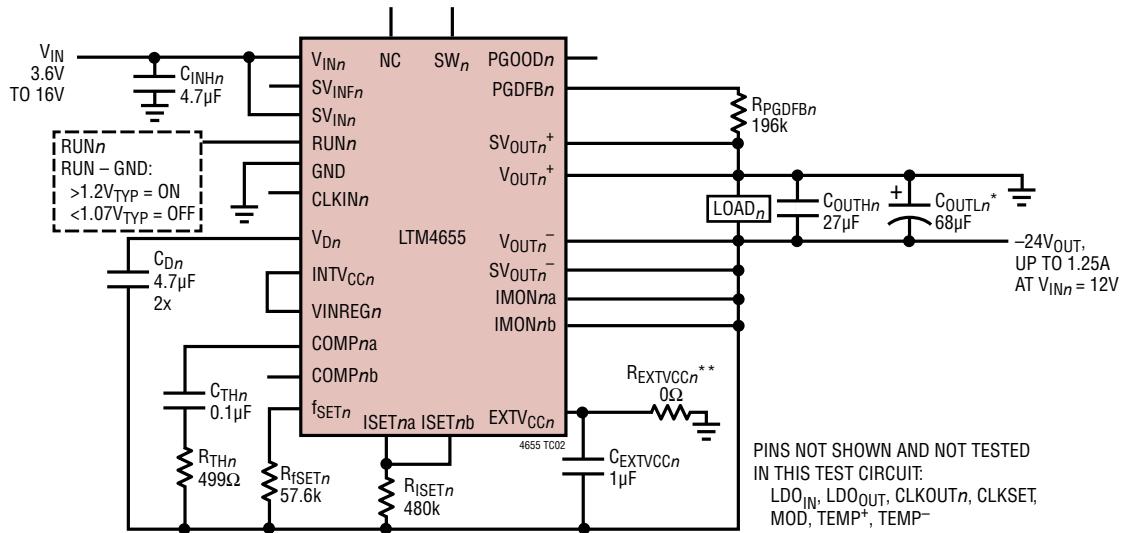

- *Polarized output capacitors C_{OUTL} , if used, must be rated to withstand $\sim 0.3V$ typical reverse polarity prior to LTM4655 start-up, stemming from a weakly forward-biased body diode. In such cases, a Schottky diode should be placed local to the LTM4655 and electrically connected between PGND and V_{OUTn}^- to limit the voltage. See the Applications Information section and Figures 49a and 49b.
- **Outside the ATE Test environment, $R_{EXTVCCn}$, if used, should not be 0Ω . See the Applications Information section.

Test Circuit 2. Negative- V_{OUT}^- Configuration, Regulating V_{OUTn}^- , One Channel Shown

TEST CIRCUIT

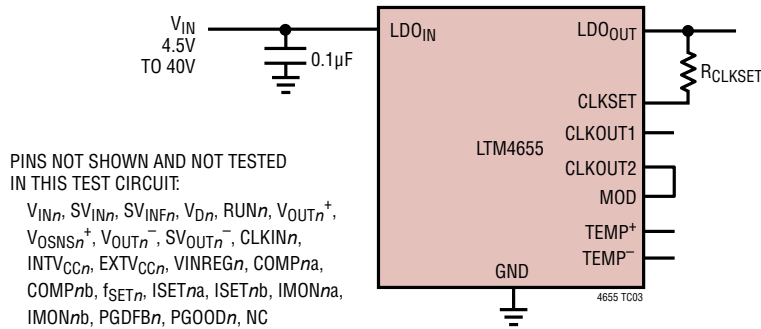

Test Circuit 3. Clock-Generator, 5V LDO and Temperature-Sensor

DECOUPLING REQUIREMENTS

$T_A = 25^\circ\text{C}$. Refer to Test Circuit 1 and Test Circuit 2.

APPLICATION	SYMBOL	PARAMETER	CONDITIONS	MIN	TYP	MAX	UNITS
Positive- V_{OUT}^+ Operation (Noninverting Step-Down) (Test Circuit 1)	C_{INHn} , C_{Dn}	External High Frequency Input Capacitor Requirement, $27V \leq V_{IN1-GND1} \leq 40V$, $V_{OUT}^+ = 24V$	$I_{OUT}^+ = 4A$		9.4		μF
	C_{OUTHn}	External High Frequency Output Capacitor Requirement $27V \leq V_{IN1-GND1} \leq 40V$, $V_{OUT}^+ = 24V$	$I_{OUT}^+ = 4A$		22		μF
Negative- V_{OUT}^- Operation (Inverting Output Buck-Boost) (Test Circuit 2)	C_{INHn} , C_{Dn}	External High Frequency Input Capacitor Requirement, $3.6V \leq V_{IN2-GND2} \leq 16V$, $V_{OUT}^- = -24V$	$I_{OUT}^- = 2A$		9.4		μF
	C_{OUTHn}	External High Frequency Output Capacitor Requirement $3.6V \leq V_{IN2-GND2} \leq 16V$, $V_{OUT}^- = -24V$	$I_{OUT}^- = 2A$		22		μF

OPERATION

Power Module Overview

The LTM4655 is a dual-channel non-isolated switch mode DC/DC power supply. Each channel is fully independent of the other. Each output can be configured for positive or negative polarity. A channel configured for positive- V_{OUT} operation performs step-down DC/DC conversion and regulates a positive output voltage, V_{OUTn}^+ . A channel configured for negative- V_{OUT}^- operation performs two-switch buck-boost DC/DC conversion and regulates a negative output voltage, V_{OUTn}^- (this topology is also known as a ground-referred buck converter).

An integrated LDO provides up to 25mA of output current at +5V (LDO_{OUT}) with respect to GND. This LDO powers an internal 2-phase clock oscillator, yielding flexibility to operate the switching channels 180° out-of-phase from each other.

A channel in positive- V_{OUT} configuration (see Test Circuit 1) can deliver up to 4A output current with a few external input and output capacitors. Set by a single resistor, R_{ISETn} , an LTM4655 channel regulates a positive output voltage, V_{OUTn}^+ . V_{OUTn}^+ can be set to as low as 0.5V to as high as 26.5V. Channels in this positive- V_{OUT} configuration can operate from a positive input supply rail, V_{INn} , between 3.1V and 40V. The typical application schematic is shown in Figure 45.

A channel in negative- V_{OUT}^- configuration (see Test Circuit 2) can deliver up to 4A output current with a few external input and output capacitors. The output current capability of the LTM4655 channel in this configuration is dependent on its V_{INn} and V_{OUTn} , as indicated in Figure 6. Set by a single resistor, R_{ISETn} , the LTM4655 channel regulates a negative output voltage, V_{OUTn}^- . V_{OUTn}^- can be set to as low as -26.5V to as high as -0.5V. In this negative- V_{OUT} configuration, an LTM4655 channel can operate from a positive input supply rail, V_{INn} , between 3.6V and 40V. The LTM4655 channel's safe operating area is defined by: $V_{INn} + |V_{OUTn}^-| \leq 40V$. The typical application schematic is shown in Figure 48. Though an LTM4655 channel configured to regulate V_{OUTn}^- is a ground-referred buck topology, built-in level-shift circuitry on the $RUNn$, $CLKINn$, and $PGOODn$ pins result in these pins being conveniently referred to GND (not SV_{OUTn}^-).

Each channel of the LTM4655 contains an independent, integrated constant-frequency current mode regulator, power MOSFETs, power inductor, EMI filter and other supporting discrete components. The nominal switching frequency range is from 400kHz to 3MHz, and the default operating frequency is 400kHz. Each channel can optionally be synchronized to its built-in clock oscillator $CLKOUTn$ pins or to an externally applied clock, from 250kHz to 3MHz. See the Applications Information section. Each channel of the LTM4655 supports internal and external control loop compensation. Internal loop compensation is selected by connecting the $COMPna$ and $COMPnb$ pins. Using internal loop compensation, the LTM4655 has sufficient stability margins and good transient performance with a wide range of output capacitors—even ceramic-only output capacitors. For external loop compensation, see the Applications Information section. [LTpowerCAD®](#) is available for transient load step and stability analysis. Input filter and noise cancellation circuitry reduces noise-coupling to the module's inputs and outputs, ensuring the module's electromagnetic interference (EMI) meets the limits of EN55022 Class B (see Figure 7 through Figure 9).

Pulling the $RUNn$ pin below 1.2V (with respect to GND) forces the corresponding LTM4655 channel into a shutdown state. A capacitor can be applied from $ISETna$ to SV_{OUTn}^- to program the output voltage ramp rate; or, the default LTM4655 ramp rate can be set by connecting $ISETna$ to $ISETnb$; or, voltage tracking can be implemented by interfacing rail voltages to the $ISETna$ pin. See the Applications Information section.

Multiphase operation can be employed by connecting the $CLKOUTn$ pins to their respective $CLKINn$ pins—or, by connecting an external clock source to the LTM4655's $CLKINn$ pins. See the Typical Applications section.

LDO losses within the module incurred primarily due to MOSFET driver power are optionally reduced by connecting $EXTV_{CCn}$ to V_{OUTn}^+ through an RC filter or by connecting $EXTV_{CCn}$ to a suitable voltage source.

For channels configured for positive- V_{OUT} operation, the $IMONna$ pin is an analog output current indicator that sources a current proportional to its channel's load current. (For channels configured for negative- V_{OUT}^- operation, the

OPERATION

IMON_{na} pin does not support such a feature and must be connected to V_{OUTn-}.) When IMON_{na} is electrically connected to IMON_{nb}, the voltage on the IMON_{na}/IMON_{nb} node is proportional to load current—with 1V corresponding to 4A load. If desired, IMON_{na} can be interfaced to an external parallel RC network instead of the one provided by IMON_{nb}. If IMON_{na} ever exceeds 2V, a servo loop reduces the LTM4655's output current in order to keep IMON_{na} at or below 2V. Through this servo mechanism, a parallel RC network can be connected to IMON_{na} to implement an average current limit function—if desired. When the feature is not needed, connect IMON_{na} to V_{OUTn-}.

The LTM4655 features an additional control pin called VINREG_n, which has a 2V servo threshold. This pin can be used to as an extra control pin, e.g., to reduce channel input current draw during input line sag (“brownout”) conditions. Connect VINREG_n to INTV_{CCn} when this feature is not needed.

TEMP⁺ and TEMP⁻ pins give access to a diode-connected PNP transistor, making it possible to monitor the LTM4655's internal temperature—if desired.

External component selection is primarily determined by the maximum load current and output voltage. Refer to Table 11 and Table 12 and the Test Circuits for recommended external component values.

V_{IN} to V_{OUT} Conversion Ratios

There are restrictions on the V_{IN} to V_{OUT} conversion ratios that the LTM4655 can achieve. The maximum duty cycle of the LTM4655 is 96% typical. The V_{IN} to V_{OUT} minimum dropout voltage is a function of load current when operating in high duty cycle applications. As an example, V_{OUTn(24VDC)} from the Electrical Characteristics table highlights the LTM4655's ability to regulate 24V_{OUT} at up to 4A from 29V_{IN}, when running at a switching frequency, f_{SW}, of 1.5MHz.

At very low duty cycles, the LTM4655's on-time of M_T each switching cycle should be designed to exceed the LTM4655 control loop's specified minimum on-time of 60ns, t_{ON(MIN)}, (guardband to 90ns) see Equation 4.

$$\frac{D_n}{f_{SWn}} > T_{ON(MIN)n} \quad (4)$$

where D_n (unitless) is the duty-cycle of M_{Tn}, given by Equation 5:

$$D_n = \frac{V_{OUTn+} - V_{OUTn-}}{V_{INn} - V_{OUTn-}} \quad (5)$$

In rare cases where the minimum on-time restriction is violated, the channel *n* frequency of the LTM4655 automatically and gradually folds back down to approximately one-fifth of its programmed switching frequency to allow V_{OUT} to remain in regulation. See the Frequency Adjustment section. Be reminded of Notes 2 and 3 in the Electrical Characteristics section regarding output current guidelines.

Input Capacitors, Positive-V_{OUT} Operation

The LTM4655 achieves low input conducted EMI noise due to tight layout and high frequency bypassing of MOSFETs M_{Tn} and M_{Bn} within the module itself. A small filter inductor (400nH) is integrated in the input line (from V_{INn} to V_{Dn}), providing further noise attenuation—again, local to the switching MOSFETs. The V_{Dn} and V_{INn} pins are available for external input capacitors—C_{Dn} and C_{INHn}—to form a high-frequency π filter. As shown in the Simplified Block Diagram, the ceramic capacitor C_{Dn} on the LTM4655's V_{Dn} pins handles the majority of the RMS current into the DC/DC converter power stage and requires careful selection, for that reason.

See Figure 7 through Figure 9 for demonstration of LTM4655's EMI performance, meeting the radiated emissions requirements of EN55022B.

The input capacitance, C_{Dn}, is needed to filter the pulsed current drawn by M_{Tn}. To prevent excessive voltage sag on V_{Dn}, a low-effective series resistance (low-ESR, such as an X7R ceramic) input capacitor should be used, sized appropriately for the maximum C_{Dn} RMS ripple current (Equation 6)

$$I_{CDn(RMS)} = \frac{I_{OUTn(MAX)}}{\eta_n\%} \cdot \sqrt{D_n \cdot (1-D_n)} \quad (6)$$

where η_n% is the estimated efficiency of the channel *n* power module. (See Typical Performance Characteristics graphs.)

OPERATION

Several capacitors may be paralleled to meet the application's target size, height, and C_{Dn} RMS ripple current rating. For lower input voltage applications, sufficient bulk input capacitance is needed to counteract line sag and transient effects during output load changes. The bulk capacitor can be a switcher-rated aluminum electrolytic capacitor or a Polymer capacitor. Suggested values for C_{Dn} and C_{INHn} are found in Table 11.

A final precaution regarding ceramic capacitors concerns the maximum input voltage rating of the LTM4655's V_{INn} , SV_{INn} , and V_{Dn} pins. A ceramic input capacitor combined with trace or cable inductance forms a high Q (under-damped) tank circuit. If the LTM4655 circuit is plugged into a live supply, the input voltage can ring to twice its nominal value, possibly exceeding the device's rating. This situation is easily avoided; see the Hot Plugging Safely section.

Output Capacitors, Positive- V_{OUT} Operation

Output capacitors C_{OUTHn} and C_{OUTLn} are applied across the LTM4655's V_{OUTn}^+/V_{OUTn}^- power output pins. Sufficient capacitance and low ESR are called for, to meet the output voltage ripple, loop stability, and transient requirements. C_{OUTLn} can be a low ESR tantalum or polymer capacitor. C_{OUTHn} is a ceramic capacitor. The typical output capacitance is $22\mu\text{F}$ (type X5R material, or better), if ceramic-only output capacitors are used.

Table 11 shows a matrix of suggested output capacitors optimized for 2A transient step-loads applied at $2A/\mu\text{s}$. Additional output filtering may be required by the system designer, if further reduction of output ripple or dynamic transient spike is required. The LTpowerCAD design tool is available for transient and stability analysis. Stability criteria are considered in the Table 11 matrix, and LTpowerCAD is available for stability analysis. Multiphase operation will reduce effective output ripple as a function of the number of phases. [Application Note 77](#) discusses this noise reduction versus output ripple current cancellation, but the output capacitance should be considered carefully as a function of stability and transient response. LTpowerCAD can be used to calculate the output ripple reduction as the number of implemented phases increases by N times.

External loop compensation can be applied from $\text{COMP}n$ to SV_{OUTn}^- , if needed, for transient response optimization.

Forced Continuous Operation

Leave the $\text{CLKIN}n$ pin open circuit to command channel n of the LTM4655 for forced continuous operation. In this mode, the control loop is allowed to command the inductor peak current to approximately -1A , allowing for significant negative average current. Clocking the $\text{CLKIN}n$ pin at a frequency within $\pm 40\%$ of the target switching frequency commanded by the f_{SETn} pin synchronizes M_{Tn} 's turn-on to the rising edge of the $\text{CLKIN}n$ pin.

Output Voltage Programming, Tracking and Soft-Start

The LTM4655 regulates its output voltage, $V_{OUTn}^+ - V_{OUTn}^-$, according to the differential voltage present from $\text{ISET}na$ to SV_{OUTn}^- . In most applications, the output voltage is set by simply connecting a resistor, $R_{\text{ISET}n}$, from $\text{ISET}na$ to SV_{OUTn}^- , according to Equation 7.

$$R_{\text{ISET}n} = \frac{V_{OUTn}^+ - V_{OUTn}^-}{50\mu\text{A}} \quad (7)$$

Since the LTM4655 control loop servos its output voltage according to the voltage between $\text{ISET}na$ and SV_{OUTn}^- : placing a capacitor, C_{SSn} , parallel to $R_{\text{ISET}n}$ configures the ramp-up rate of $\text{ISET}na$ and thus the output. In the time domain, the output voltage ramp-up after the $\text{RUN}n$ pin is toggled from low to high ($t = 0\text{s}$) is given by Equation 8.

$$V_{OUTn}(t)^+ - V_{OUTn}(t)^- = I_{\text{ISET}na} \cdot R_{\text{ISET}n} \cdot \left(1 - e^{-\frac{t}{R_{\text{ISET}n} \cdot C_{SSn}}} \right) \quad (8)$$

The soft-start time, t_{SS} , is defined as the time it takes for channel n 's output voltage to ramp from 0V to 90% of its final value (Equation 9 or Equation 10)

$$t_{SSn} = -R_{\text{ISET}n} \cdot C_{SSn} \cdot \ln(1 - 0.9) \quad (9)$$

or

$$t_{SSn} = 2.3 \cdot R_{\text{ISET}n} \cdot C_{SSn} \quad (10)$$

OPERATION

A default value of $C_{SSn} = 1.5\text{nF}$ can be implemented by connecting ISET n a to ISET n b. For other ramp-up rates, connect an external C_{SS} capacitor parallel to R_{ISET} .

When starting up into a pre-biased V_{OUT} , the LTM4655 stays in a sleep mode, keeping M_{Tn} and M_{Bn} off until V_{ISETna} equals V_{OSNSn}^+ —after which, the DC/DC converter commences switching action and V_{OUT} is ramped according to the voltage commanded by ISET n a.

Since the LTM4655 control loop servos its V_{OSNSn}^+ voltage to match that of ISET n a's, the LTM4655's channel n output can be configured to track any voltage applied to ISET n a, referenced to SV_{OUTn}^- . See Figure 52 for an example of the LTM4655 configured as a DAC-controlled bipolar-output programmable power supply.

The LTM4655 can track the mirror-image of a positive rail to generate the negative half of a split-supply, as seen in Figure 50 (note the use of R_{TRACK} and $R_{ISET2} = R_{ISET1} \parallel R_{TRACK}$).

Frequency Adjustment

The default switching frequency (f_{SWn}) of channel n of the LTM4655 is 400kHz. This is suitable for low- V_{IN} ($V_{INn} \leq 5\text{V}$) applications and low- V_{OUT} ($V_{OUTn}^+ - V_{OUTn}^- \leq 3.3\text{V}$) applications. For a practical design, the LTM4655's inductor ripple current (ΔI_{nPK-PK}) is suggested to be less than $\sim 2A_{PK-PK}$. Choose f_{SWn} according to Equation 11.

$$f_{SWn} = \frac{V_{OUTn}^+ - V_{OUTn}^- \cdot (1 - D_n)}{L_n \cdot \Delta I_{nPK-PK}} \quad (11)$$

where the value of LTM4655's power inductor, L_n , is $4\mu\text{H}$.

To avoid cycle-skipping, impose restrictions on f_{SWn} , to ensure minimum on-time criteria is met (Equation 12).

$$f_{SWn} < \frac{D_n}{T_{ONn(MIN)}} \quad (12)$$

The LTM4655's minimum on-time, $t_{ONn(MIN)}$, is specified as 60ns. For a practical design, it is recommended to guardband to 90ns.

To configure channel n of the LTM4655 for a higher switching frequency than its default of 400kHz, apply a resistor, R_{fSETn} , between the f_{SETn} pin and SV_{OUTn}^+ . R_{fSETn} is given (in $M\Omega$) by Equation 13.

$$R_{fSETn}(M\Omega) = \frac{1}{10\text{pF} \cdot [f_{SWn}(\text{MHz}) - 0.4(\text{MHz})]} \quad (13)$$

The relationship of R_{fSETn} to programmed f_{SWn} is shown in Figure 1. See Table 11 and Table 12 for recommended f_{SWn} and corresponding R_{fSETn} values for various combinations of V_{INn} , V_{OUTn}^+ and V_{OUTn}^- .

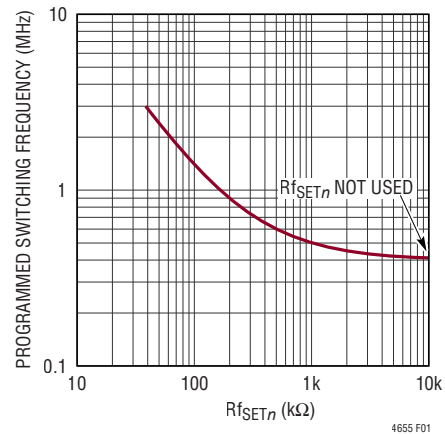

Figure 1. Relationship Between R_{fSETn} and Target f_{SWn}

APPLICATIONS INFORMATION

Power Module Protection

The LTM4655's current mode control architecture provides fast cycle-by-cycle current limit in an overcurrent condition, as shown in the Typical Performance Characteristics section. If the output voltage collapses sufficiently due to an overload or short-circuit condition, minimum on-time will be violated and the internal oscillator will then fold-back automatically to one-fifth of the LTM4655's programmed switching frequency—thereby reducing the output current and affording the load a chance to recover.

The LTM4655 ceases channel n switching action if the channel's internal temperatures exceed 165°C. The channel's control IC resumes operation after a 10°C cool-down hysteresis. Note that these typical parameters are based on measurements in a lab oven and are not production tested. This overtemperature protection is intended to protect the device during momentary overload conditions. The maximum rated junction temperature will be exceeded when this overtemperature protection is active. Continuous operation above the specified absolute maximum operating junction temperature may impair device reliability or permanently damage the device. See Note 1 of the Electrical Characteristics table.

The LTM4655 does not feature any specialized output overvoltage protection beyond what is inherent to the control loop's servo mechanism.

RUN Pin Enable

The RUN n pin is used to enable the power module or sequence the power module. The threshold is 1.2V. The RUN n pin can be used to provide an undervoltage lockout (UVLO) function by connecting a resistor divider from the input supply to the RUN n pin, as shown in Figure 2. Undervoltage lockout keeps channel n of the LTM4655 in shutdown until the supply input voltage is above a certain voltage programmed by the user. The RUN n pin hysteresis voltage prevents noise from falsely tripping

UVLO. Resistors are chosen by first selecting R_{Bn} (refer to Figure 2 and Equation 14). Then:

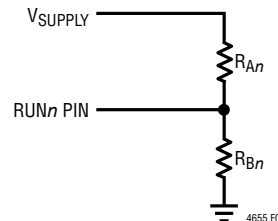

Figure 2. Undervoltage Lockout Resistive Divider

$$R_{An} = R_{Bn} \cdot \left(\frac{V_{INn(ON)}}{1.2V} - 1 \right) \quad (14)$$

where $V_{INn(ON)}$ is the input voltage at which the undervoltage lockout is overcome and the supply turns on. The V_{INn} turn-off voltage, $V_{INn(OFF)}$ is given by Equation 15.

$$V_{INn(OFF)} = 1.07V \cdot \left(\frac{R_{An}}{R_{Bn}} + 1 \right) \quad (15)$$

If UVLO is not needed, RUN n can be connected to LTM4655's LDO $_{OUT}$ pin.

When RUN n is below its threshold, UVLO of channel n is engaged, M_{Tn} and M_{Bn} are turned off, $INTV_{CCn}$ ceases to be regulated, and ISET na is discharged to SV_{OUTn}^- by internal circuitry.

Loop Compensation

External loop compensation may be preferred for some applications and can be implemented easily, as follows: leave COMP nb open circuit; connect a series-RC network R_{THn} and C_{THn} from COMP nb to SV_{OUTn}^- ; in some instances, connect a capacitor (C_{THPn}) from COMP na to SV_{OUTn}^- (paralleling the R_{THn} - C_{THn} series-RC network). See Table 11 and Table 12 for suggested input and output capacitances for a variety of operating conditions. Additionally, the LTpowerCAD design tool is available for transient and stability analysis.

APPLICATIONS INFORMATION

Hot Plugging Safely

The small size, robustness and low impedance of ceramic capacitors make them an attractive option for the input bypass capacitors (C_{Dn} and C_{INHn}) of the LTM4655. However, these capacitors can cause problems if the LTM4655 is plugged into a live supply (see Analog Devices [Application Note 88](#) for a complete discussion). The low loss ceramic capacitor combined with stray inductance in series with the power source forms an under damped tank circuit, and the voltage at the V_{INn} pin of the LTM4655 can ring to twice the nominal input voltage, possibly exceeding the LTM4655's rating and damaging the part. If the input supply is poorly controlled or the user will be plugging the LTM4655 into an energized supply, the input network should be designed to prevent this overshoot by introducing a damping element into the path of current flow. This is often done by adding an inexpensive electrolytic bulk capacitor (C_{INLn}) across the input terminals of the LTM4655. The selection criteria for C_{INLn} calls for: an ESR high enough to damp the ringing; a capacitance value several times larger than C_{INHn} ; a suitable ripple current rating. C_{INLn} does not need to be located physically close to the LTM4655; it should be located close to the application board's input connector, instead.

Input Disconnect/Input Short Considerations

If at any point the input supply is removed with the output voltage still held high through its capacitor, power will be drawn from the output capacitor to power the module, until the output voltage drops below the minimum SV_{INn}/V_{INn} requirements of the module.

However, if the SV_{INn}/V_{INn} pins are grounded while the output is held high, regardless of the $RUNn$ state, parasitic body diodes inside the LTM4655 will pull current from the output through the V_{OUTn}^+ pins. Depending on the size of the output capacitor and the resistivity of the short, high currents may flow through the internal body diode, and cause damage to the part. If discharge of SV_{INn}/V_{INn} by the input source is possible, preventative measures should be taken to prevent current flow through the internal body diode. Simple solutions would be placing a Schottky diode in series with the supply (Figure 3), or placing a Schottky diode from V_{OUTn}^+ to SV_{INn}/V_{INn}

(Figure 4). Applications with loads that experience large load-step release, load dump or other mechanisms that invoke reverse energy flow in the Figure 3 circuit may need a suitably-rated Zener diode protection clamp, to limit the resulting transient voltage rise on SV_{INn}/V_{INn} and C_{INHn} .

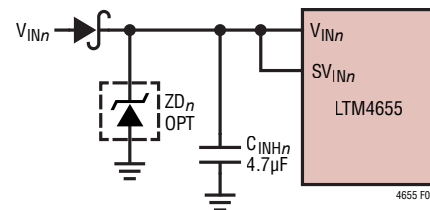

Figure 3. Schottky Diode in Series with the Supply

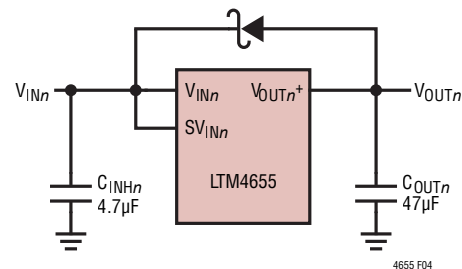

Figure 4. Schottky Diode from V_{OUTn}^+ to V_{INn}

INTV_{CCn} and EXTV_{CCn} Connection

When $RUNn$ is logic high, an internal low dropout regulator regulates an internal supply, $INTV_{CCn}$, that powers the control circuitry for driving LTM4655's channel n internal MOSFETs. $INTV_{CCn}$ is regulated at 3.3V. In this manner, the LTM4655's $INTV_{CCn}$ is directly powered from SV_{INn} , by default. The gate driver current through the $INTV_{CCn}$ LDO is about 20mA for a typical 1MHz application. The internal LDO power dissipation can be calculated as shown in Equation 16.

$$P_{LDO_LOSSn(INTVCC)} = 20\text{mA} \cdot (SV_{INn}^- - V_{OUTn}^- - 3\text{V}) \quad (16)$$

The LDO draws current off of $EXTV_{CCn}$ instead of SV_{INn} when $EXTV_{CCn} - V_{OUTn}^-$ exceeds 3.2V and $SV_{INn}^- - SV_{OUTn}^-$ exceeds 5V. For output voltages of 4V and higher, $EXTV_{CCn}$

APPLICATIONS INFORMATION

can be connected to V_{OUTn}^+ through an RC-filter. When the internal LDO derives power from $EXTV_{CCn}$ instead of SV_{INn} , the internal LDO power dissipation is shown in Equation 17.

$$P_{LDO_LOSSn(EXTVCC)} = 20mA \cdot (V_{OUTn}^+ - V_{OUTn}^- - 3V) \quad (17)$$

The recommended value of the resistor between V_{OUTn}^+ and $EXTV_{CCn}$ is roughly $(V_{OUTn}^+ - V_{OUTn}^-) \cdot 4\Omega/V$. This resistor, $R_{EXTVCCn}$, must be rated to continually dissipate $(0.02A)^2 \cdot R_{EXTVCCn}$. The primary purpose of this resistor is to prevent $EXTV_{CCn}$ overstress under a fault condition. For example, when an inductive short-circuit is applied to the module's output, V_{OUT}^+ may be briefly dragged below V_{OUTn}^- —forward biasing the V_{OUTn}^- -to- $EXTV_{CCn}$ body diode. This resistor limits the magnitude of current flow in $EXTV_{CCn}$. If the application requires a low resistive path to $EXTV_{CCn}$, apply a protective Schottky diode across $EXTV_{CCn}$ and V_{OUTn}^- ; see Figure 52. Bypass $EXTV_{CCn}$ to V_{OUTn}^- with $1\mu F$ of X5R (or better) MLCC.

Multiphase Operation

Multiple LTM4655 channels and modules can be paralleled for higher output current applications. For lowest input and output voltage and current ripples, it is advisable to synchronize paralleled LTM4655s to a clock (within $\pm 40\%$ of the target switching frequency set by f_{SETn}).

LTM4655 channels and modules can be paralleled without synchronizing circuits: just be aware that some beat-frequency ripple will be present in the output voltage and reflected input current by virtue of the fact that such modules are not operating at identical, synchronized switching frequencies.

The LTM4655 device is an inherently current mode controlled device, so parallel channels and modules will have good current sharing as shown in Figure 45 and Figure 47.

To parallel LTM4655 channels and/or modules, connect the respective $COMPna$, $ISETna$, and V_{OSNSn}^+ pins of each LTM4655 together to share the current evenly. In addition, tie the respective $RUNn$ pins of paralleled LTM4655 channels and/or modules together, to ensure proper start-up and shutdown behavior.

Note that for parallel applications, V_{OUT} can be set by a single, common resistor on the $ISETna$ net (see Equation 18).

$$R_{ISETn} = \frac{V_{OUTn}^+ - V_{OUTn}^-}{50\mu A \cdot N} \quad (18)$$

where N is the number of LTM4655 channels in parallel configuration.

Depending on the duty cycle of operation, the output voltage ripple achieved by paralleled, synchronized LTM4655 modules may be considerably smaller than what is yielded by a single-phase solution. [Application Note 77](#) provides a detailed explanation of multiphase operation (relevant to parallel LTM4655 applications) pertaining to noise reduction and output and input ripple current cancellation. Regardless of ripple current cancellation, it remains important for the output capacitance of paralleled LTM4655 applications to be designed for loop stability and transient response. LTpowerCAD is available for such analysis.

Figure 5 illustrates the RMS ripple current reduction as a function of the number of interleaved (paralleled and synchronized) LTM4655 modules—derived from [Application Note 77](#).

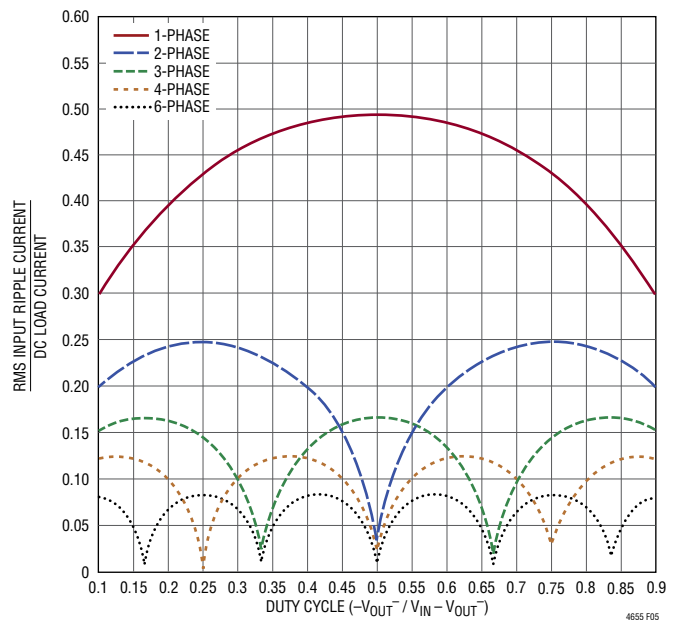

Figure 5. Normalized Input RMS Ripple Current vs Duty Cycle for One to Six LTM4655 Channels (Phases)

APPLICATIONS INFORMATION

Negative Output Current Capability Varies as a Function of V_{INn} to V_{OUTn}^- Conversion Ratios, Negative- V_{OUT}^- Operation

In negative- V_{OUT} operation, the output current capability of the LTM4655 has a strong dependency on the operating input (V_{INn}) and output (V_{OUTn}^-) voltages. See Figure 6.

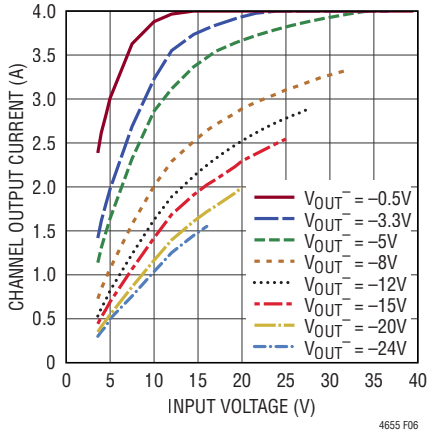

Figure 6. Channel Output Current Capability*, Negative- V_{OUT} Operation

*Current limit frequency-foldback activates at load currents higher than indicated curves. Continuous channel output current capability subject to details of application implementation. Switching frequency set per Table 1. See Notes 2 and 3.

The reason for this is inherent in the two-switch buck-boost topology employed by the LTM4655 when so-configured for negative- V_{OUT} operation. To protect the primary power MOSFET (M_{Tn}) from overstress (see Simplified Block Diagram), its peak current (I_{nPK}) is limited by control circuitry to 6A. When M_{Tn} is on, observe that no current flows to LTM4655's output; furthermore, observe that only when M_{Tn} is off does current flow to the output of the LTM4655. As a consequence of this arrangement: for a given output voltage, current limit inception activates sooner at low line (higher, larger duty cycle) than at high line (lower, smaller duty cycle). A further consequence is: for a given input voltage, the output power capability of the LTM4655 is higher for lower-magnitude V_{OUTn}^- (lower, smaller duty cycle) than for higher-magnitude V_{OUTn}^- (higher, larger duty cycle). The combination of

these effects is shown the plots in Figure 6 and described by Equation 19.

$$I_{OUTn(CAPABILITY)} = \frac{V_{INn} \cdot \left(I_{nPK} - \frac{\Delta I_{nPK-PK}}{2} \right) \cdot \eta_n}{V_{INn} - V_{OUTn}^-} \quad (19)$$

where:

ΔI_{nPK-PK} is the channel n inductor ripple current, in amps, and η_n (unitless) is the channel efficiency of the LTM4655.

For completeness, ΔI_{nPK-PK} is given by Equation 20.

$$\Delta I_{nPK-PK} = \frac{1}{L_n \cdot f_{SWn} \cdot \left(\frac{1}{V_{INn}} - \frac{1}{V_{OUTn}^-} \right)} \quad (20)$$

where:

L_n is 4 μ H, the LTM4655 channel's power inductor value, and f_{SWn} is the switching frequency of the LTM4655's channel, in MHz.

For a practical design, ΔI_{nPK-PK} is designed to be less than $\sim 2A_{PK-PK}$.

For a practical design, the LTM4655's on-time of M_{Tn} each switching cycle should be designed to exceed the LTM4655 control loop's specified minimum on-time of 60ns, $t_{ON(MIN)}$, (guardband to 90ns). For example, Equation 21.

$$\frac{D_n}{f_{SWn}} > T_{ONn(MIN)} \quad (21)$$

where D_n (unitless) is the duty-cycle of M_{Tn} , given by Equation 22.

$$D = \frac{V_{OUTn}^+ - V_{OUTn}^-}{V_{INn} - V_{OUTn}^-} \quad (22)$$

Combining Equation 22 with Equation 19, it can be illustrative to see Equation 23.

$$I_{OUTn(CAPABILITY)} = (1 - Dn) \cdot \left(I_{nPK} - \frac{\Delta I_{nPK-PK}}{2} \right) \cdot \eta_n \quad (23)$$

APPLICATIONS INFORMATION

In rare cases where the minimum on-time restriction is violated, the frequency of the affected LTM4655 channel(s) automatically and gradually folds back down to one-fifth of its programmed switching frequency to allow V_{OUTn}^- to remain in regulation.

Be reminded of Notes 2, and 3 in the Electrical Characteristics section regarding output current guidelines.

Input Capacitors, Negative- V_{OUT}^- Operation

The LTM4655 achieves low input conducted EMI noise due to tight layout and high-frequency bypassing of MOSFETs M_{Tn} and M_{Bn} within the module itself. A small

filter inductor (400nH) is integrated in the input line (from V_{INn} to V_{Dn}) provides further noise attenuation—again, local to the switching MOSFETs. The V_{Dn} and V_{INn} pins are available for external input capacitors— C_{Dn} and C_{INHn} —to form a high-frequency π filter. As shown in the Simplified Block Diagram, the ceramic capacitor C_{Dn} on the LTM4655's V_{Dn} pins handles the majority of the RMS current into the DC/DC converter power stage and requires careful selection, for that reason.

To meet the radiated emissions requirements of EN55022B, an additional filter capacitor, C_{INOUTn} , is needed—connecting from V_{INn} to V_{OUTn}^- . See Figure 7 through Figure 9 for EMI performance.

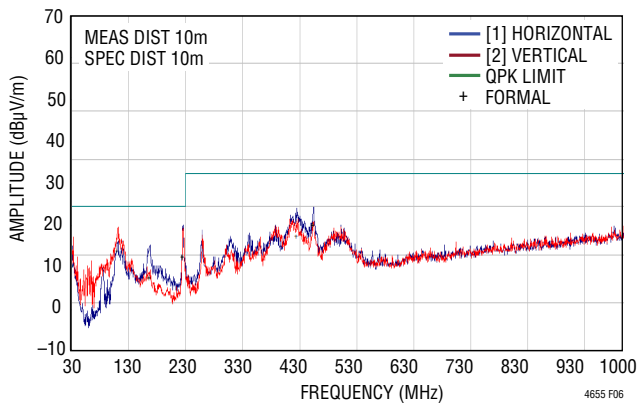

Figure 7. Radiated Emissions Scan of the LTM4655. Producing 24V_{OUT} at 7A, from 36V_{IN}. DC2898A Hardware. $f_{SW} = 1.2\text{MHz}$. Measured in a 10m Chamber. Peak Detect Method

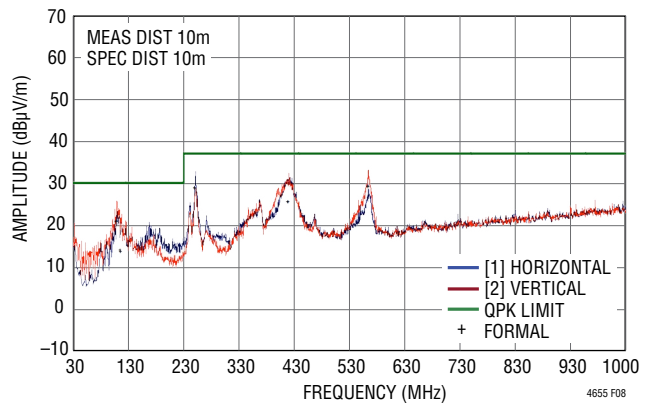

Figure 8. Radiated Emissions Scan of the LTM4655. Producing -24V_{OUT} at 2A, from 12V_{IN}, DC2899A Hardware. $f_{SW} = 1.2\text{MHz}$. Measured in a 10m Chamber. Peak Detect Method

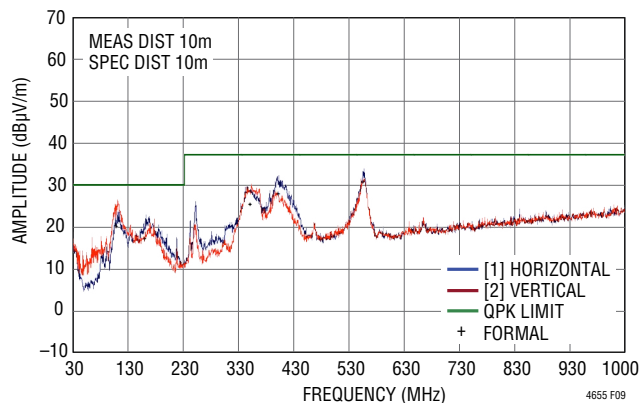

Figure 9. Radiated Emissions Scan of the LTM4655. Producing -12V_{OUT} at 4A, from 12V_{IN}. DC2899A Hardware. $f_{SW} = 700\text{kHz}$. Measured in a 10m Chamber. Peak Detect Method

APPLICATIONS INFORMATION

The input capacitance, C_{Dn} , is needed to filter the pulsed current drawn by M_{Tn} . To prevent excessive voltage sag on V_{Dn} , a low-effective series resistance (low-ESR) input capacitor should be used, sized appropriately for the maximum C_{Dn} RMS ripple current (see Equation 24).

$$I_{CDn(RMS)} = I_{nPK} \cdot \sqrt{D_n \cdot (1 - D_n)} \quad (24)$$

$I_{CDn(RMS)}$ is maximum for $D_n = 1/2$. For $D_n = 1/2$, $I_{CDn(RMS)} = 1/2 \cdot I_{nPK}$ or 3A. This simplification of the worst-case condition is commonly used for design purposes because even significant deviations in D_n do not offer much relief, in practice. Furthermore: note that ripple current ratings from capacitor manufacturers are often based on 2000 hours of life; therefore, it is advisable to significantly over-design C_{Dn} , and/or choose a capacitor rated at a higher temperature than required. Err on the side of caution and contact the capacitor manufacturer to understand the capacitor vendor's derating methodology.

Several capacitors may be paralleled to meet the application's target size, height, and C_{Dn} RMS ripple current rating. For lower input voltage applications, sufficient bulk input capacitance is needed for C_{INLn} to counteract line sag and transient effects during output load changes. Suggested values for C_{Dn} and C_{INHn} are found in Table 12. Take note that C_{Dn} is connected from V_{Dn} to V_{OUTn-} , whereas C_{INHn} and C_{INLn} are connected from V_{INn} to power ground; this is deliberate.

A final precaution regarding ceramic capacitors concerns the maximum input voltage rating of the LTM4655's V_{INn} , SV_{INn} , and V_{Dn} pins. A ceramic input capacitor combined with trace or cable inductance forms a high Q (under-damped) tank circuit. If the LTM4655 circuit is plugged into a live supply, the input voltage can ring to twice its nominal value, possibly exceeding the device's rating. This situation is easily avoided; see the Hot Plugging Safely section.

Output Capacitors, Negative- V_{OUT-} Operation

Output capacitors C_{OUTHn} and C_{OUTLn} are applied across the LTM4655's V_{OUTn+}/V_{OUTn-} power output pins: sufficient capacitance and low ESR are called for, to meet the output voltage ripple, loop stability, and transient requirements. C_{OUTLn} can be a low ESR tantalum or polymer

capacitor. C_{OUTHn} is a ceramic capacitor. The typical output capacitance is 22 μ F (type X5R material, or better), if ceramic-only output capacitors are used.

For highest reliability designs, polarized output capacitors (C_{OUTLn}) are not recommended, as there is a possibility of a diode-drop of reverse voltage appearing transiently on V_{OUTn-} during rapid application of input voltage or when $RUNn$ is toggled logic high (see Figure 49). When polarized capacitors are used on V_{OUTn-} , contact the capacitor vendor to understand what reverse voltage their polarized capacitor can withstand. Be advised, polarized capacitor reverse voltage rating is sometimes temperature-dependent.

Output voltage ripple ($\Delta V_{OUTn(PK-PK)-}$) is governed by charge lost in C_{OUTHn} and C_{OUTLn} while M_{Tn} is on, in addition to the contribution of a resistive drop across the ESR of the output capacitors. This is expressed by Equation 25.

$$\Delta V_{OUTn(PK-PK)-} \approx \frac{I_{LOADn} \cdot D}{C_{OUTn} \cdot f_{SWn}} + \frac{I_{LOADn} \cdot ESR_n}{D_n} \quad (25)$$

Table 12 shows a matrix of suggested output capacitors optimized for transient step-loads that are 50% of the full load capability for that combination of V_{INn} , V_{OUTn-} , and f_{SWn} . The table optimizes total equivalent ESR and total bulk capacitance to yield the stated transient-load performance. Additional output filtering may be required by the system designer, if further reduction of output ripple or dynamic transient spike is required. The LTpowerCAD design tool is available for transient and stability analysis.

Optional Diodes to Guard Against Overstress, Negative- V_{OUT-} Operation

Just prior to output voltage start-up, a mechanism exists whereby a diode-drop of reverse polarity can appear on V_{OUTn-} . See the Simplified Block Diagram and observe: just prior to output voltage start-up, SV_{INn} bias current (I_{SVINn}) flows through the module's control IC, to SV_{OUTn-} ; from there, the bias current (now $I_{SVOUTn-}$) flows into V_{OUTn-} and through M_{Bn} 's body diode, to SW_n . This current (now I_{Ln}) continues to flow—though the 4 μ H power inductor—to V_{OUTn+} and thus ground, closing the control IC bias circuit's path. It is this current through M_{Bn} 's

APPLICATIONS INFORMATION

body diode that creates a diode-drop of reverse polarity (positive voltage) on V_{OUTn^-} , as shown in Figure 49. The voltage excursion is highest when $RUNn$ toggles high because that is the instant when $INTV_{CCn}$ powers-up, with a corresponding increase in $I_{SVINn}/I_{SVOUTn^-}/I_{L_n}$ current flow. With higher current flow, the forward voltage drop (V_F) of M_{Bn} 's body diode—and thus, the positive voltage excursion on V_{OUTn^-} is higher.

If this transient voltage excursion is unwelcome for the load or polarized output capacitors, minimize it with a low V_F Schottky diode that straddles V_{OUTn^-} and V_{OUTn^+} (see Figure 48 circuit and Figure 49 performance). Additionally, the voltage excursion can be empirically reduced by increasing output capacitance.

Lastly: in applications where it is anticipated that V_{INn} may be rapidly applied (e.g., $<10\mu s$) and C_{INOUTn} is used, the resulting capacitor-divider network formed by C_{INOUTn} and $C_{INL_n}||C_{INH_n}$ may transiently drag V_{OUTn^-} positive. It is recommended to apply a low V_F Schottky diode from V_{OUTn^-} to V_{OUTn^+} in such applications. The reverse mechanism applies, as well: in applications where it is anticipated that V_{INn} may be rapidly discharged and C_{INOUTn} is used, the resulting capacitor-divider network formed by C_{INOUTn} and $C_{INL_n}||C_{INH_n}$ may transiently drag V_{OUTn^-} excessively negative. It is recommended to straddle V_{OUTn^-} and V_{OUTn^+} with a TVS diode, if output voltage excursions during V_{INn} -discharge are anticipated.

Frequency Adjustment, Negative- V_{OUT^-} Operation

The default switching frequency (f_{SWn}) of channel n of the LTM4655 is 400kHz. This is suitable for mainly low- V_{IN} or low- V_{OUT^-} applications ($V_{INn} < 5V$ or $|V_{OUTn^-}| < 5V$). For a practical design, the LTM4655's inductor ripple current (Δ_{nPK-PK}) is suggested to be less than $\sim 2A_{PK-PK}$. From Equation 20, it follows that f_{SW} should be chosen such that Equation 26).

$$f_{SWn} = \frac{1}{L_n \cdot \Delta_{nPK-PK} \cdot \left(\frac{1}{V_{INn}} - \frac{1}{V_{OUTn^-}} \right)} \quad (26)$$

In some cases, the value of f_{SWn} yielded by Equation 26 violates the supported minimum on-time of the LTM4655 (see Equation 21). If this occurs, choose f_{SWn} instead according to Equation 12.

The primary consequence of using a lower switching frequency than that dictated by Equation 26 is that the output current capability of the LTM4655 is reduced, according to Equation 23.

To configure the channel n of the LTM4655 for a higher switching frequency than 400kHz default, apply a resistor, R_{fSETn} , between the f_{SETn} pin and SV_{OUTn^-} . R_{fSETn} is given (in $M\Omega$) by Equation 13.

The relationship of R_{fSETn} to programmed f_{SWn} is shown in Figure 1.

See Table 1 and Table 12 for Recommended f_{SWn} and associated R_{fSETn} values for various combinations of V_{INn} and V_{OUTn^-} .

Table 1. Recommended Channel n Switching Frequency (f_{SWn}) and R_{fSETn} for Common Combinations of V_{INn} and V_{OUTn^-} , Negative- V_{OUTn^-} Operation

		V_{OUTn^-} (V)							
		-0.5	-3.3	-5	-8	-12	-15	-20	-24
V_{INn} (V)	3.6	400kHz, No R_{fSETn}	400kHz, No R_{fSETn}	400kHz, No R_{fSETn}	400kHz, No R_{fSETn}	400kHz, No R_{fSETn}	425kHz, 4.3M Ω	450kHz, 2.2M Ω	
	5			450kHz, 2.2M Ω	475kHz, 1.3M Ω	500kHz, 1M Ω	525kHz, 806k Ω	550kHz, 665k Ω	
	12			550kHz, 665k Ω	700kHz, 332k Ω	825kHz, 237k Ω	875kHz, 210k Ω	900kHz, 200k Ω	1MHz, 165k Ω
	24	Drive $CLKIN_n$ with a 200kHz Clock, No R_{fSETn}	450kHz, 2.2M Ω	600kHz, 499k Ω	800kHz, 249k Ω	1.1MHz, 143k Ω	1.2MHz, 124k Ω	N/A	N/A
	36	Not Recommended Due to On-Time Criteria Violation	500kHz, 1M Ω	N/A Due to SOA Criteria Violation					

Rev. B

APPLICATIONS INFORMATION

Radiated EMI Noise

The generation of radiated EMI noise is an inherent disadvantage of switching regulators. Fast switching turn-on and turn-off of the power MOSFETs—necessary for achieving high efficiency—create high-frequency (~30MHz+) Δ_V/Δ_t changes within DC/DC converters. This activity tends to be the dominant source of high-frequency EMI radiation in such systems. The high level of device integration within LTM4655—including optimized gate-driver and critical front-end π filter inductor—delivers low radiated EMI noise performance. Figure 7 through Figure 9 show typical examples of LTM4655 meeting the radiated emission limits established by EN55022 Class B.

Thermal Considerations and Output Current Derating

The thermal resistances reported in the Pin Configuration section are consistent with those parameters defined by JESD51-12 and are intended for use with finite element analysis (FEA) software modeling tools that leverage the outcome of thermal modeling, simulation, and correlation to hardware evaluation performed on a μ Module package mounted to a hardware test board. The motivation for providing these thermal coefficients is found in JESD51-12 (“Guidelines for Reporting and Using Electronic Package Thermal Information”).

Many designers may opt to use laboratory equipment and a test vehicle such as the demo board to predict the μ Module regulator’s thermal performance in their application at various electrical and environmental operating conditions to compliment any FEA activities. Without FEA software, the thermal resistances reported in the Pin Configuration section are, in and of themselves, not relevant to providing guidance of thermal performance; instead, the derating curves provided in this data sheet can be used in a manner that yields insight and guidance pertaining to one’s application-usage, and can be adapted to correlate thermal performance to one’s own application.

The Pin Configuration section gives four thermal coefficients explicitly defined in JESD51-12; these coefficients are quoted or paraphrased below:

1. θ_{JA} , the thermal resistance from junction-to-ambient, is the natural convection junction-to-ambient air thermal resistance measured in a one cubic foot sealed enclosure. This environment is sometimes referred to as “still air” although natural convection causes the air to move. This value is determined with the part mounted to a JESD51-9 defined test board, which does not reflect an actual application or viable operating condition.
2. $\theta_{JCbottom}$, the thermal resistance from junction to the bottom of the product case, is determined with all of the component power dissipation flowing through the bottom of the package. In the typical μ Module regulator, the bulk of the heat flows out the bottom of the package, but there is always heat flow out into the ambient environment. As a result, this thermal resistance value may be useful for comparing packages but the test conditions don’t generally match the user’s application.
3. θ_{JCtop} , the thermal resistance from junction to top of the product case, is determined with nearly all of the component power dissipation flowing through the top of the package. As the electrical connections of the typical μ Module regulator are on the bottom of the package, it is rare for an application to operate such that most of the heat flows from the junction to the top of the part. As in the case of $\theta_{JCbottom}$, this value may be useful for comparing packages but the test conditions don’t generally match the user’s application.
4. θ_{JB} , the thermal resistance from junction to the printed circuit board, is the junction-to-board thermal resistance where almost all of the heat flows through the bottom of the μ Module regulator and into the board, and is really the sum of the $\theta_{JCbottom}$ and the thermal resistance of the bottom of the part through the solder joints and through a portion of the board. The board temperature is measured a specified distance from the package, using a two sided, two layer board. This board is described in JESD51-9.

A graphical representation of the aforementioned thermal resistances is given in Figure 10; blue resistances are contained within the μ Module regulator, whereas green resistances are external to the μ Module package.

APPLICATIONS INFORMATION

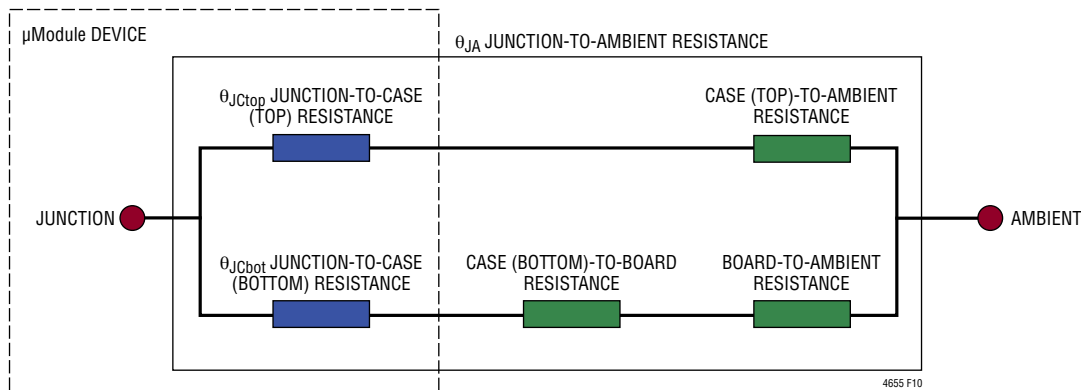

Figure 10. Graphical Representation of JEDEC Thermal Coefficients

As a practical matter, it should be clear to the reader that no individual or sub-group of the four thermal resistance parameters defined by JEDEC or provided in the Pin Configuration section replicates or conveys normal operating conditions of a μ Module regulator. For example, in normal board-mounted applications, never does 100% of the device's total power loss (heat) thermally conduct exclusively through the top or exclusively through bottom of the μ Module package—as the standard defines for θ_{JCtop} and $\theta_{JCbottom}$, respectively. In practice, power loss is thermally dissipated in both directions away from the package—granted, in the absence of a heat sink and airflow, a majority of the heat flow is into the board.

Within the LTM4655, be aware there are multiple power devices and components dissipating power, with a consequence that the thermal resistances relative to different junctions of components or die are not exactly linear with respect to total package power loss. To reconcile this complication without sacrificing modeling simplicity—but also not ignoring practical realities—an approach has been taken using FEA software modeling along with laboratory testing in a controlled-environment chamber to reasonably define and correlate the thermal resistance values supplied in this data sheet: (1) Initially, FEA software is used to accurately build the mechanical geometry of the LTM4655 and the specified PCB with all of the correct material coefficients along with accurate power loss source definitions; (2) this model simulates a software-defined JEDEC environment consistent with JEDEC 51-9 and JEDEC 51-12 to predict power loss heat flow and

temperature readings at different interfaces that enable the calculation of the JEDEC-defined thermal resistance values; (3) the model and FEA software is used to evaluate the LTM4655 with heat sink and airflow; (4) having solved for and analyzed these thermal resistance values and simulated various operating conditions in the software model, a thorough laboratory evaluation replicates the simulated conditions with thermocouples within a controlled environment chamber while operating the device at the same power loss as that which was simulated. The outcome of this process and due diligence yields the set of derating curves provided in later sections of this data sheet, along with well-correlated JEDEC-defined θ values provided in the Pin Configuration section.

For positive- V_{OUT} applications, the $12V_{IN}$ and $24V_{IN}$ power loss curves in Figure 11 and Figure 12, respectively, can be used with the load current derating curves in Figure 13 to Figure 24 for calculating an approximate θ_{JA} thermal resistance for the LTM4655 with various heat sinking and air flow conditions. For negative- V_{OUT} applications: use instead the $-5V_{OUT}$, $-12V_{OUT}$ and $-24V_{OUT}$ power loss curves in Figure 25 to Figure 27, respectively, in combination with the load current derating curves in Figure 28 to Figure 43. For split-supply applications, total power loss within the module will dictate the thermal derating; interpolate the relevant derating curves. These thermal resistances represent demonstrated performance of the LTM4655 on DC2898A and DC2899A hardware; 4-layer FR4 PCB measuring $97\text{mm} \times 116\text{mm} \times 1.6\text{mm}$ using outer and inner copper weights of 2oz and 1oz,

APPLICATIONS INFORMATION

respectively. The power loss curves are taken at room temperature, and are increased with multiplicative factors with ambient temperature. These approximate factors are listed in Table 1. (Compute the factor by interpolation, for intermediate temperatures.) The derating curves are plotted with the LTM4655's outputs paralleled and inteleased, sourcing its maximum output capability, in an environment with temperature-controlled ambient. The output voltages are $1V_{OUT}$, $5V_{OUT}$, $15V_{OUT}$, $-5V_{OUT}$, $-15V_{OUT}$ and $-24V_{OUT}$. These are chosen to include the lower and higher output voltage ranges for correlating the thermal resistance. Thermal models are derived from several temperature measurements in a controlled temperature chamber along with thermal modeling analysis. The junction temperatures are monitored while ambient temperature is increased with and without air flow, and with and without a heat sink attached with thermally conductive adhesive tape. The power loss increase with ambient temperature change is factored into the derating curves. The junctions are maintained at 120°C maximum while lowering output current or power while increasing ambient temperature. The decreased output current decreases the internal module loss as ambient temperature is increased. The monitored junction temperature of 120°C minus the ambient operating temperature specifies how much module temperature rise can be allowed. As an example in Figure 30, the load current is derated to 3.05A per channel (6.1A, combined) at 60°C ambient with no airflow and no heat sink and the room temperature (25°C) per channel power loss for this $24V_{IN}$ to $-5V_{OUT}$ at 3.05A out condition is 2.45W; 4.9W, combined. A 5.39W loss is calculated by multiplying the 4.9W room temperature loss from the $24V_{IN}$ to $-5V_{OUT}$

power loss curve at 4.9W (Figure 25), with the 1.1 multiplying factor at 60°C ambient (from Table 2). If the 60°C ambient temperature is subtracted from the 120°C junction temperature, then the difference of 60°C divided by 5.39W yields a thermal resistance, θ_{JA} , of 11.1°C/W—in good agreement with Table 6. Table 3 to Table 5 provide equivalent thermal resistances for 1V, 5V, and 15V outputs with and without airflow and heatsinking. Table 6 to Table 8 provide equivalent thermal resistances for $-5V$, $-15V$ and $-24V$ outputs with and without airflow and heatsinking. The derived thermal resistances in Table 3 to Table 8 for the various conditions can be multiplied by the calculated power loss as a function of ambient temperature to derive temperature rise above ambient, thus maximum junction temperature. Room temperature power loss can be derived from the efficiency curves in the Typical Performance Characteristics section and adjusted with ambient temperature multiplicative factors from Table 2.

Table 2. Power Loss Multiplicative Factors vs Ambient Temperature

AMBIENT TEMPERATURE	POWER LOSS MULTIPLICATIVE FACTOR
Up to 40°C	1.00
50°C	1.05
60°C	1.10
70°C	1.15
80°C	1.20
90°C	1.25
100°C	1.30
110°C	1.35
120°C	1.40

APPLICATIONS INFORMATION

Table 3. 1V Output

DERATING CURVE	V _{IN} (V)	POWER LOSS CURVE	AIRFLOW (LFM)	HEAT SINK	θ _{JA} (°C/W)
Figure 13, Figure 14, Figure 15	5, 12, 24	Figure 11, Figure 12	0	None	11.9
Figure 13, Figure 14, Figure 15	5, 12, 24	Figure 11, Figure 12	200	None	10.9
Figure 13, Figure 14, Figure 15	5, 12, 24	Figure 11, Figure 12	400	None	10.0
Figure 16, Figure 17, Figure 18	5, 12, 24	Figure 11, Figure 12	0	BGA Heat Sink	11.2
Figure 16, Figure 17, Figure 18	5, 12, 24	Figure 11, Figure 12	200	BGA Heat Sink	10.1
Figure 17, Figure 17, Figure 18	5, 12, 24	Figure 11, Figure 12	400	BGA Heat Sink	9.1

Table 4. 5V Output

DERATING CURVE	V _{IN} (V)	POWER LOSS CURVE	AIRFLOW (LFM)	HEAT SINK	θ _{JA} (°C/W)
Figure 19, Figure 20	12, 24	Figure 11, Figure 12	0	None	11.9
Figure 19, Figure 20	12, 24	Figure 11, Figure 12	200	None	10.9
Figure 19, Figure 20	12, 24	Figure 11, Figure 12	400	None	10.0
Figure 21, Figure 22	12, 24	Figure 11, Figure 12	0	BGA Heat Sink	11.2
Figure 21, Figure 22	12, 24	Figure 11, Figure 12	200	BGA Heat Sink	10.1
Figure 21, Figure 22	12, 24	Figure 11, Figure 12	400	BGA Heat Sink	9.1

Table 5. 15V Output

DERATING CURVE	V _{IN} (V)	POWER LOSS CURVE	AIRFLOW (LFM)	HEAT SINK	θ _{JA} (°C/W)
Figure 23	24	Figure 12	0	None	11.9
Figure 23	24	Figure 12	200	None	10.9
Figure 23	24	Figure 12	400	None	10.0
Figure 24	24	Figure 12	0	BGA Heat Sink	11.2
Figure 24	24	Figure 12	200	BGA Heat Sink	10.1
Figure 24	24	Figure 12	400	BGA Heat Sink	9.1

APPLICATIONS INFORMATION

Table 6. –5V Output

DERATING CURVE	V _{IN} (V)	POWER LOSS CURVE	AIRFLOW (LFM)	HEAT SINK	θ _{JA} (°C/W)
Figure 28, Figure 29, Figure 30	5, 12, 24	Figure 25	0	None	11.9
Figure 28, Figure 29, Figure 30	5, 12, 24	Figure 25	200	None	10.9
Figure 28, Figure 29, Figure 30	5, 12, 24	Figure 25	400	None	10.0
Figure 31, Figure 32, Figure 33	5, 12, 24	Figure 25	0	BGA Heat Sink	11.2
Figure 31, Figure 32, Figure 33	5, 12, 24	Figure 25	200	BGA Heat Sink	10.1
Figure 31, Figure 32, Figure 33	5, 12, 24	Figure 25	400	BGA Heat Sink	9.1

Table 7. –15V Output

DERATING CURVE	V _{IN} (V)	POWER LOSS CURVE	AIRFLOW (LFM)	HEAT SINK	θ _{JA} (°C/W)
Figure 34, Figure 35, Figure 36	5, 12, 24	Figure 26	0	None	11.9
Figure 34, Figure 35, Figure 36	5, 12, 24	Figure 26	200	None	10.9
Figure 34, Figure 35, Figure 36	5, 12, 24	Figure 26	400	None	10.0
Figure 37, Figure 38, Figure 39	5, 12, 24	Figure 26	0	BGA Heat Sink	11.2
Figure 37, Figure 38, Figure 39	5, 12, 24	Figure 26	200	BGA Heat Sink	10.1
Figure 37, Figure 38, Figure 39	5, 12, 24	Figure 26	400	BGA Heat Sink	9.1

Table 8. –24V Output

DERATING CURVE	V _{IN} (V)	POWER LOSS CURVE	AIRFLOW (LFM)	HEAT SINK	θ _{JA} (°C/W)
Figure 40, Figure 41	5, 12	Figure 27	0	None	11.9
Figure 40, Figure 41	5, 12	Figure 27	200	None	10.9
Figure 40, Figure 41	5, 12	Figure 27	400	None	10.0
Figure 42, Figure 43	5, 12	Figure 27	0	BGA Heat Sink	11.2
Figure 42, Figure 43	5, 12	Figure 27	200	BGA Heat Sink	10.1
Figure 42, Figure 43	5, 12	Figure 27	400	BGA Heat Sink	9.1

Table 9. Heat Sink Manufacturer (Thermally Conductive Adhesive Tape Pre-Attached)

HEAT SINK MANUFACTURER	PART NUMBER	WEBSITE
Aavid Thermalloy	375424B00034G	www.aavid.com
Cool Innovations	4-050503PT411	www.coolinnovations.com
Wakefield Engineering	LTN20069	www.wakefield.com

Table 10. Thermally Conductive Adhesive Tape Vendor

THERMALLY CONDUCTIVE ADHESIVE TAPE MANUFACTURER	PART NUMBER	WEBSITE
Chomerics	T411	www.chomerics.com

APPLICATIONS INFORMATION

Table 11. Positive Output Voltage Response vs Component Matrix. Performance of a Channel of LTM4655 in Figure 51 Circuit, with Values Here Indicated. Load-Stepping from 2A to 4A Load Current, at 2A/μs. Typical Measured Values

C _{OUTHn} VENDORS	PART NUMBER	C _{OUTHn} VENDORS	PART NUMBER
AVX	12066D107MAT2A (100μF, 6.3V, 1206 Case Size)	AVX	12105D106MAT2A (10μF, 50V, 1210 Case Size)
Murata	GRM31CR60J107M (100μF, 6.3V, 1206 Case Size)	Murata	GRM32ER61H106M (10μF, 50V, 1210 Case Size)
Taiyo Yuden	JMK316BBJ107MLHT (100μF, 6.3V, 1206 Case Size)	Taiyo Yuden	UMK325BJ106M (10μF, 50V, 1210 Case Size)
TDK	C3216X5R0J107M (100μF, 6.3V, 1206 Case Size)	TDK	C3225X5R1H106M (10μF, 50V, 1210 Case Size)
C _{OUTHn} VENDORS	PART NUMBER	C _{INHn} /C _{Dn} VENDORS	PART NUMBER
AVX	1210YD476MAT2A (47μF, 16V, 1210 Case Size)	Murata	GRM32ER71K475M (4.7μF, 80V, 1210 Case Size)
Murata	GRM32ER61C476M (47μF, 16V, 1210 Case Size)	AVX	12065C475MAT2A (4.7μF, 50V, 1206 Case Size)
Taiyo Yuden	EMK325BJ476MM (47μF, 16V, 1210 Case Size)	Murata	GRM31CR71H475M (4.7μF, 50V, 1206 Case Size)
AVX	12103D226MAT2A (22μF, 25V, 1210 Case Size)	Taiyo Yuden	UMK316AB7475ML (4.7μF, 50V, 1206 Case Size)
Taiyo Yuden	TMK325BJ226MM (22μF, 25V, 1210 Case Size)	TDK	C3216X5R1H475M (4.7μF, 50V, 1206 Case Size)
TDK	C3225X5R1E226M (22μF, 25V, 1210 Case Size)		

V _{OUTn} (V)	V _{INn} (V)	C _{INHn}	C _{Dn}	C _{OUTHn}	R _{THn} (Ω)	C _{THn} (nF)	R _{SETn} (kΩ)	R _{PGDFBn} (kΩ)	f _{SWn} (kHz)	R _{SETn} (kΩ)	R _{EXTVCCn} (Ω)	LOAD STEP TRANSIENT DROOP (mV)	LOAD STEP PK-PK DEVIATION (mV)	RECOVERY TIME (μs)
1	5	4.7μF	4.7μF	100μF x 3	681	6.8	20	3.32	400	N/A	N/A	70	145	55
1	12	4.7μF	4.7μF	100μF x 3	681	6.8	20	3.32	400	N/A	N/A	70	145	50
1	24	4.7μF	4.7μF	100μF x 3	681	6.8	20	3.32	400	N/A	N/A	70	145	50
1.2	5	4.7μF	4.7μF	100μF x 3	665	6.8	24	4.99	400	N/A	N/A	70	145	50
1.2	12	4.7μF	4.7μF	100μF x 3	665	6.8	24	4.99	400	N/A	N/A	70	145	50
1.2	24	4.7μF	4.7μF	100μF x 3	665	6.8	24	4.99	400	N/A	N/A	70	145	50
1.5	5	4.7μF	4.7μF	100μF x 3	665	6.8	30.1	7.5	400	N/A	N/A	70	145	50
1.5	12	4.7μF	4.7μF	100μF x 3	665	6.8	30.1	7.5	400	N/A	N/A	70	145	50
1.5	24	4.7μF	4.7μF	100μF x 3	665	6.8	30.1	7.5	400	N/A	N/A	70	145	50
1.5	36	4.7μF	4.7μF	100μF x 3	665	6.8	30.1	7.5	400	N/A	N/A	70	145	50
1.8	5	4.7μF	4.7μF	100μF x 3	665	8.2	36	10	400	N/A	N/A	70	145	50
1.8	12	4.7μF	4.7μF	100μF x 3	665	8.2	36	10	400	N/A	N/A	70	145	50
1.8	24	4.7μF	4.7μF	100μF x 3	665	8.2	36	10	400	N/A	N/A	70	145	50
1.8	36	4.7μF	4.7μF	100μF x 3	665	8.2	36	10	400	N/A	N/A	70	145	50
2.5	5	4.7μF	4.7μF	100μF x 3	649	8.2	50	15.8	400	N/A	N/A	70	145	50
2.5	12	4.7μF	4.7μF	100μF x 3	649	8.2	50	15.8	400	N/A	N/A	70	145	50
2.5	24	4.7μF	4.7μF	100μF x 3	649	8.2	50	15.8	400	N/A	N/A	70	145	50
2.5	36	4.7μF	4.7μF	100μF x 3	649	8.2	50	15.8	400	N/A	N/A	70	145	50
3.3	5	4.7μF	4.7μF	100μF x 2	604	10	66.5	22.6	400	N/A	N/A	90	190	50
3.3	12	4.7μF	4.7μF	100μF x 2	604	10	66.5	22.6	400	N/A	N/A	90	190	50
3.3	24	4.7μF	4.7μF	100μF x 2	604	10	66.5	22.6	400	N/A	N/A	90	185	50
3.3	36	4.7μF	4.7μF	100μF x 2	604	10	66.5	22.6	400	N/A	N/A	90	180	50
5	12	4.7μF	4.7μF	47μF x 2	499	10	100	36.5	400	N/A	20	130	260	45
5	24	4.7μF	4.7μF	47μF x 2	499	10	100	36.5	550	665	20	130	260	45
5	36	4.7μF	4.7μF	47μF x 2	499	10	100	36.5	575	576	20	130	260	45
12	15	4.7μF	4.7μF	22μF x 2	499	10	240	95.3	500	1000	49.9	170	350	40
12	24	4.7μF	4.7μF	22μF x 2	499	10	240	95.3	800	249	49.9	170	350	40
12	36	4.7μF	4.7μF	22μF x 2	499	10	240	95.3	1100	143	49.9	170	350	40
15	24	4.7μF	4.7μF	22μF x 2	499	10	301	121	750	287	60.4	170	350	40
15	36	4.7μF	4.7μF	22μF x 2	499	10	301	121	1200	124	60.4	170	350	40
24	36	4.7μF	4.7μF	10μF x 2	499	10	481	196	1200	124	100	220	430	35

APPLICATIONS INFORMATION

Table 12. Negative Output Voltage Response vs Component Matrix. Performance of Figure 48 Circuit with Values Here Indicated. Load-Stepping from 50% of Full Scale (F.S.) to 100% of F.S. Load Current, in 1 μ s. Typical Measured Values.

C _{OUTn} VENDORS	PART NUMBER	C _{INHn} /C _{Dn} VENDORS	PART NUMBER
AVX	12066D107MAT2A (100 μ F, 6.3V, 1206 Case Size)	Murata	GRM32ER71K475M (4.7 μ F, 80V, 1210 Case Size)
Murata	GRM31CR60J107M (100 μ F, 6.3V, 1206 Case Size)	AVX	12065C475MAT2A (4.7 μ F, 50V, 1206 Case Size)
Taiyo Yuden	JMK316BBJ107MLHT (100 μ F, 6.3V, 1206 Case Size)	Murata	GRM31CR71H475M (4.7 μ F, 50V, 1206 Case Size)
TDK	C3216X5R0J107M (100 μ F, 6.3V, 1206 Case Size)	Taiyo Yuden	UMK316AB7475ML (4.7 μ F, 50V, 1206 Case Size)
AVX	1210YD476MAT2A (47 μ F, 16V, 1210 Case Size)	TDK	C3216X5R1H475M (4.7 μ F, 50V, 1206 Case Size)
Murata	GRM32ER61C476M (47 μ F, 16V, 1210 Case Size)		
Taiyo Yuden	EMK325BJ476MM (47 μ F, 16V, 1210 Case Size)		
AVX	12103D226MAT2A (22 μ F, 25V, 1210 Case Size)		
Taiyo Yuden	TMK325BJ226MM (22 μ F, 25V, 1210 Case Size)		
TDK	C3225X5R1E226M (22 μ F, 25V, 1210 Case Size)		
AVX	12105D106MAT2A (10 μ F, 50V, 1210 Case Size)		
Murata	GRM32ER61H106M (10 μ F, 50V, 1210 Case Size)		
Taiyo Yuden	UMK325BJ106M (10 μ F, 50V, 1210 Case Size)		
TDK	C3225X5R1H106M (10 μ F, 50V, 1210 Case Size)		

V _{OUTn} (V)	V _{INn} (V)	F.S. LOAD (A)	C _{INHn} (V _{INn} TO GND BYPASS CAP)	C _{INOUTn} (V _{INn} TO V _{OUTn} BYPASS CAP)	C _{Dn} (V _{Dn} TO V _{OUTn} BYPASS CAP)	CDGNDn (V _{Dn} TO GND BYPASS CAP)	C _{OUTn} (CERAMIC OUTPUT CAP)	R _{ISEn} (k Ω)	R _{PGDFBn} (k Ω)	f _{SWn} (kHz)	R _{ISEn} (k Ω)	R _{EXTVCCn} (Ω)	LOAD STEP TRANSIENT DROOP (mV)	LOAD STEP PK-PK DEVIATION (mV)	RECOVERY TIME (μ s)
-0.5	5	3.2	4.7 μ F	4.7 μ F	4.7 μ F	4.7 μ F	100 μ F \times 4	10	N/A	400	N/A	2.2	75	150	55
-0.5	12	4	4.7 μ F	4.7 μ F	4.7 μ F	4.7 μ F	100 μ F \times 4	10	N/A	400	N/A	2.2	90	190	60
-0.5*	24	4	4.7 μ F	4.7 μ F	4.7 μ F	4.7 μ F	100 μ F \times 4	10	N/A	200**	N/A	2.2	90	190	60
-3.3	5	2.2	4.7 μ F	4.7 μ F	4.7 μ F	4.7 μ F	100 μ F	66.5	22.6	400	N/A	15	65	130	25
-3.3	12	3.5	4.7 μ F	4.7 μ F	4.7 μ F	4.7 μ F	100 μ F \times 2	66.5	22.6	400	N/A	15	165	330	50
-3.3	24	4	4.7 μ F	4.7 μ F	4.7 μ F	4.7 μ F	100 μ F \times 2	66.5	22.6	450	2200	15	175	355	50
-3.3	36	4	4.7 μ F	4.7 μ F	4.7 μ F	4.7 μ F	100 μ F \times 2	66.5	22.6	500	1000	15	160	310	40
-5	5	1.75	4.7 μ F	4.7 μ F	4.7 μ F	4.7 μ F	47 μ F \times 2	100	36.5	400	N/A	20	125	235	45
-5	12	3.2	4.7 μ F	4.7 μ F	4.7 μ F	4.7 μ F	47 μ F \times 2	100	36.5	550	665	20	175	340	60
-5	24	3.85	4.7 μ F	4.7 μ F	4.7 μ F	4.7 μ F	47 μ F \times 2	100	36.5	600	499	20	185	380	55
-8	5	1.2	4.7 μ F	4.7 μ F	4.7 μ F	4.7 μ F	47 μ F	160	61.9	450	2200	32.4	125	235	30
-8	12	2.3	4.7 μ F	4.7 μ F	4.7 μ F	4.7 μ F	47 μ F	160	61.9	700	332	32.4	185	340	30
-8	24	3.1	4.7 μ F	4.7 μ F	4.7 μ F	4.7 μ F	47 μ F	160	61.9	800	249	32.4	180	330	27
-12	5	0.9	4.7 μ F	4.7 μ F	4.7 μ F	4.7 μ F	22 μ F	240	95.3	475	1300	49.9	140	270	32
-12	12	1.9	4.7 μ F	4.7 μ F	4.7 μ F	4.7 μ F	22 μ F	240	95.3	825	237	49.9	157	290	25
-12	24	2.75	4.7 μ F	4.7 μ F	4.7 μ F	4.7 μ F	22 μ F	240	95.3	1100	143	49.9	170	325	25
-15	5	0.75	4.7 μ F	4.7 μ F	4.7 μ F	4.7 μ F	22 μ F	301	121	500	1000	60.4	90	170	25
-15	12	1.75	4.7 μ F	4.7 μ F	4.7 μ F	4.7 μ F	22 μ F	301	121	875	210	60.4	200	380	32
-15	24	2.5	4.7 μ F	4.7 μ F	4.7 μ F	4.7 μ F	22 μ F	301	121	1200	124	60.4	205	400	28
-24	5	0.55	4.7 μ F	4.7 μ F	4.7 μ F \times 2	4.7 μ F \times 2	10 μ F \times 2	481	196	550	665	100	105	220	45
-24	12	1.25	4.7 μ F	4.7 μ F	4.7 μ F \times 2	4.7 μ F \times 2	10 μ F \times 2	481	196	1000	165	100	140	275	30

*Internal loop compensation is used with Table 12 settings. COMP_na connects to COMP_nb in Figure 48.

**To avoid violating minimum on-time criteria, drive CLKIN with a 200kHz, 50% duty cycle clock.

APPLICATIONS INFORMATION—DERATING CURVES

Settings per Table 11 and Table 12.

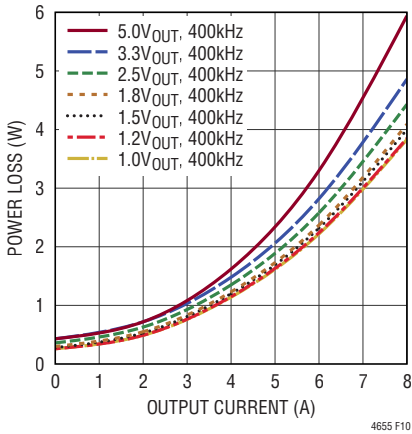

Figure 11. 12V_{IN} Power Loss Curve

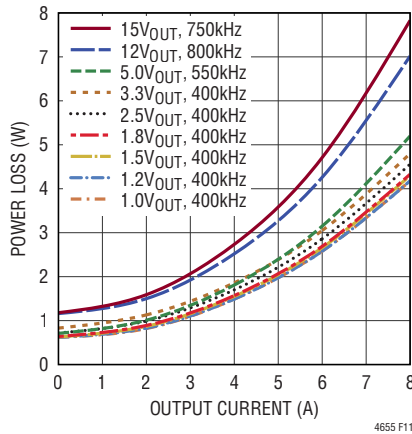

Figure 12. 24V_{IN} Power Loss Curve

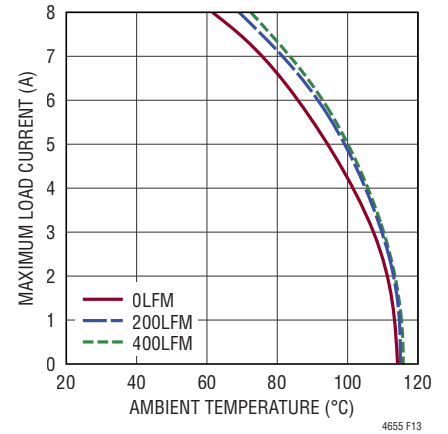

Figure 13. 5V to 1V_{OUT} Derating Curve, No Heat Sink

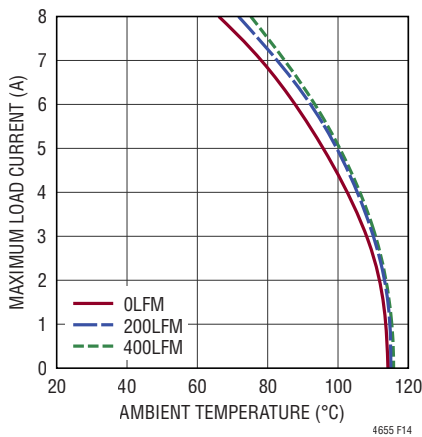

Figure 14. 12V to 1V_{OUT} Derating Curve, No Heat Sink

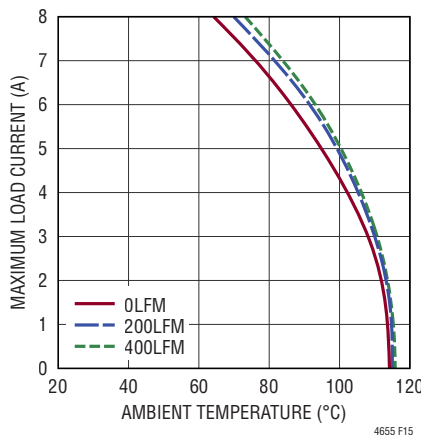

Figure 15. 24V to 1V_{OUT} Derating Curve, No Heat Sink

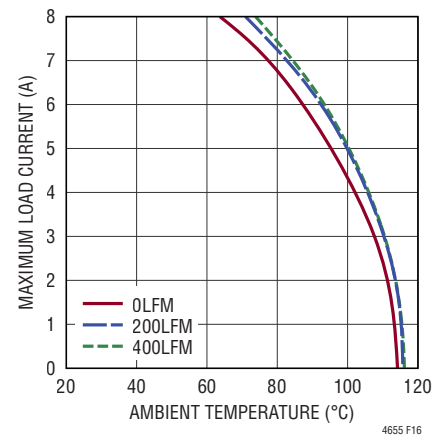

Figure 16. 5V to 1V_{OUT} Derating Curve, with BGA Heat Sink

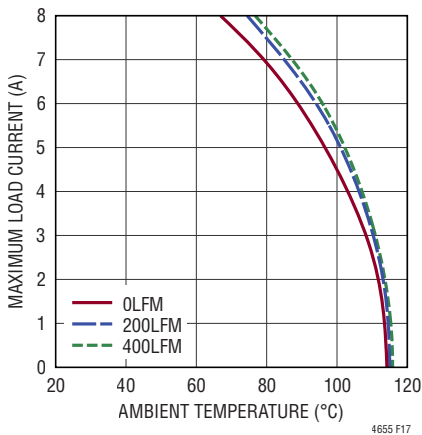

Figure 17. 12V to 1V_{OUT} Derating Curve, with BGA Heat Sink

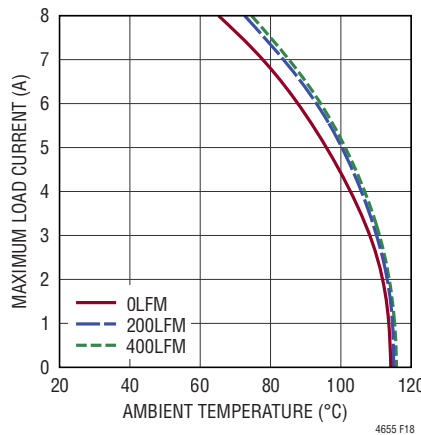

Figure 18. 24V to 1V_{OUT} Derating Curve, with BGA Heat Sink

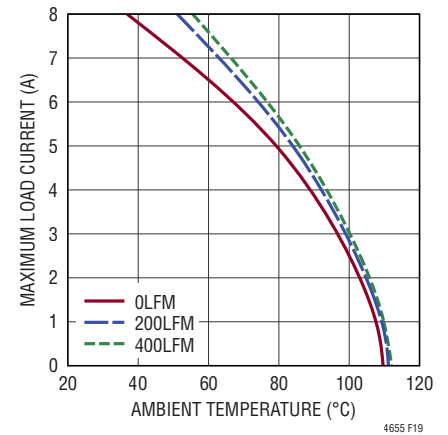

Figure 19. 12V to 5V_{OUT} Derating Curve, No Heat Sink

Rev. B

APPLICATIONS INFORMATION—DERATING CURVES

Settings per Table 11 and Table 12.

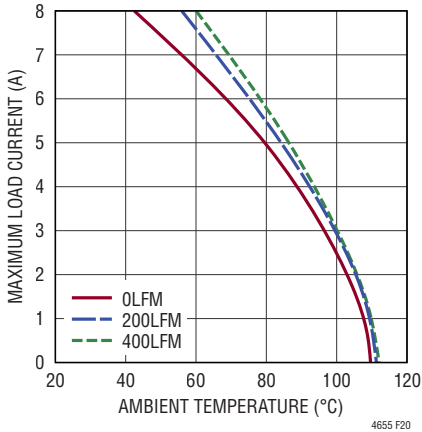

Figure 20. 24V to 5V_{OUT} Derating Curve, No Heat Sink

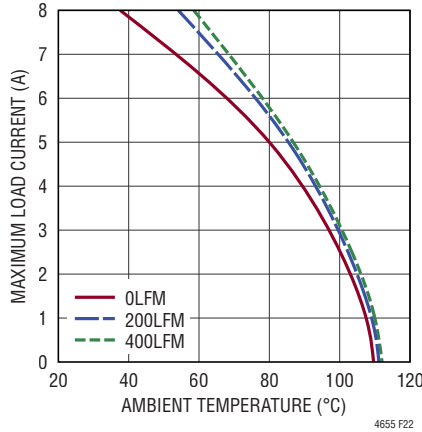

Figure 21. 12V to 5V_{OUT} Derating Curve, with BGA Heat Sink

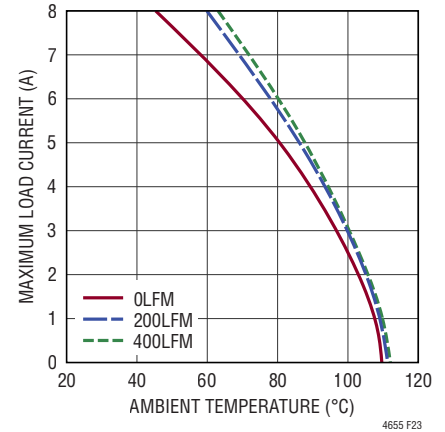

Figure 22. 24V to 5V_{OUT} Derating Curve, with BGA Heat Sink

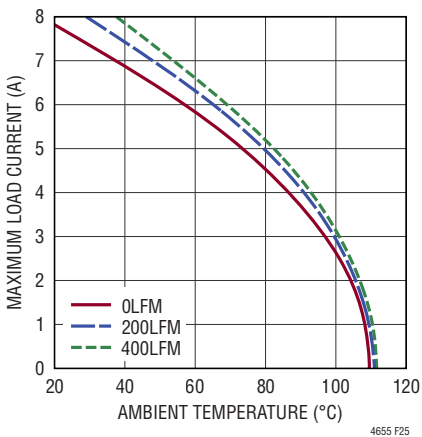

Figure 23. 24V to 15V_{OUT} Derating Curve, No Heat Sink

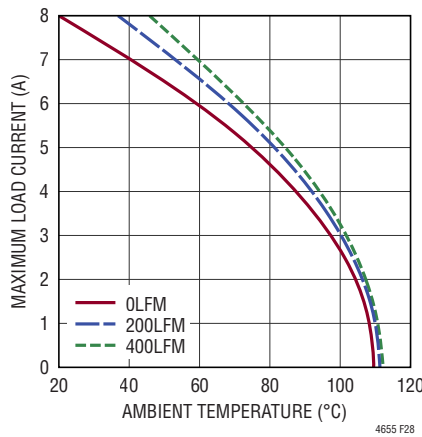

Figure 24. 24V to 15V_{OUT} Derating Curve, with BGA Heat Sink

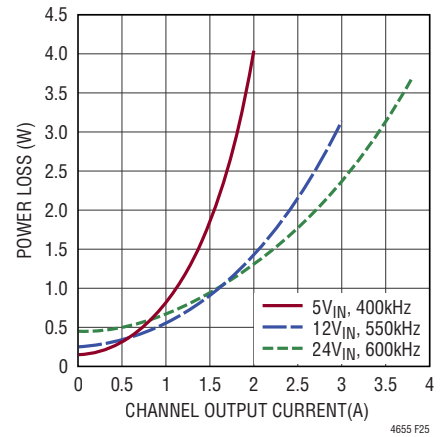

Figure 25. -5V_{OUT} Power Loss Curve

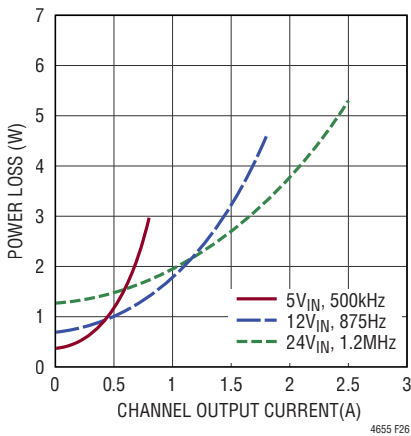

Figure 26. -15V_{OUT} Power Loss Curve

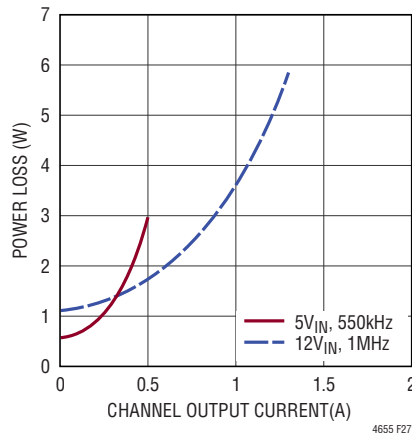

Figure 27. -24V_{OUT} Power Loss Curve

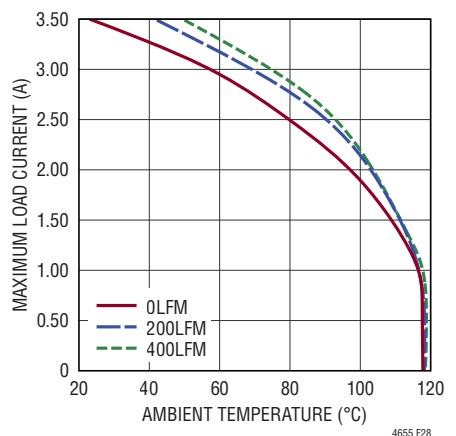

Figure 28. 5V to -5V_{OUT} Derating Curve, No Heat Sink

APPLICATIONS INFORMATION—DERATING CURVES

Settings per Table 11 and Table 12.

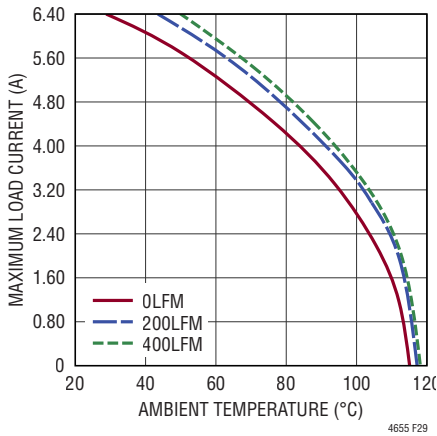

Figure 29. 12V to $-5V_{OUT}$ Derating Curve, No Heat Sink

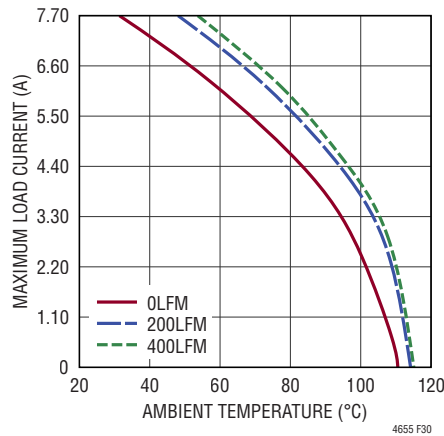

Figure 30. 24V to $-5V_{OUT}$ Derating Curve, No Heat Sink

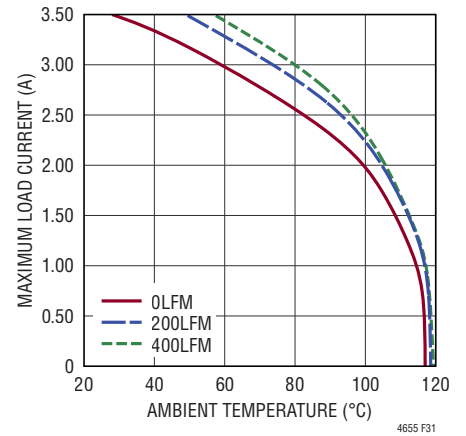

Figure 31. 5V to $-5V_{OUT}$ Derating Curve, with BGA Heat Sink

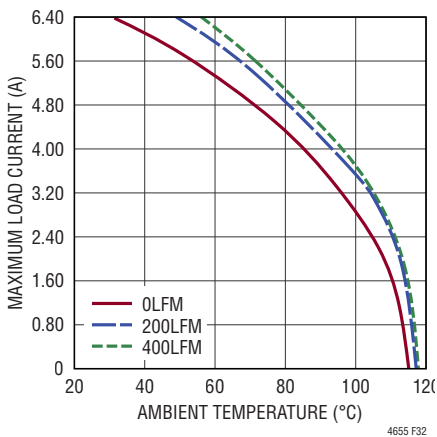

Figure 32. 12V to $-5V_{OUT}$ Derating Curve, with BGA Heat Sink

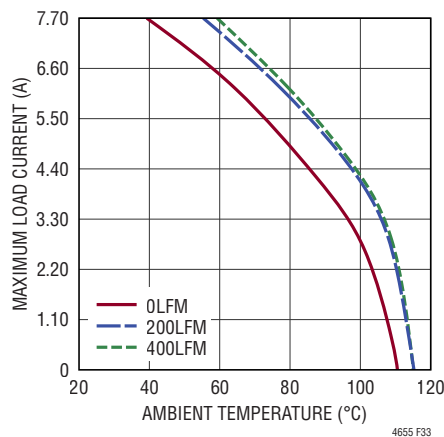

Figure 33. 24V to $-5V_{OUT}$ Derating Curve, with BGA Heat Sink

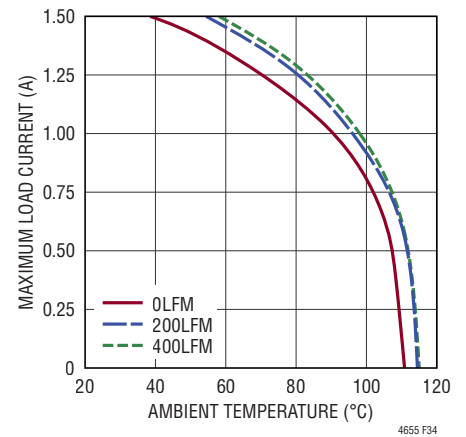

Figure 34. 5V to $-15V_{OUT}$ Derating Curve, No Heat Sink

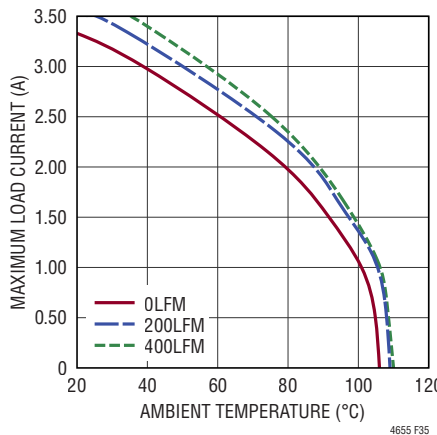

Figure 35. 12V to $-15V_{OUT}$ Derating Curve, No Heat Sink

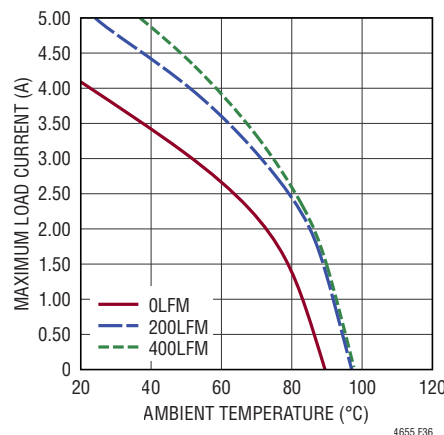

Figure 36. 24V to $-15V_{OUT}$ Derating Curve, No Heat Sink

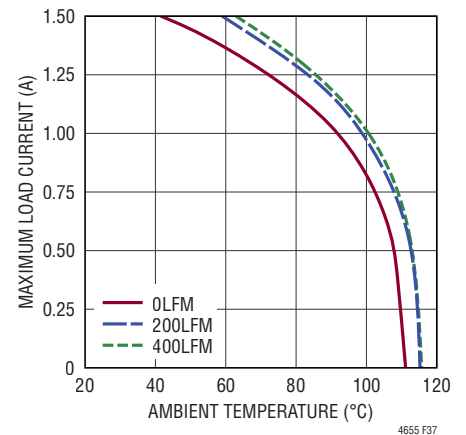

Figure 37. 5V to $-15V_{OUT}$ Derating Curve, with BGA Heat Sink

Rev. B

APPLICATIONS INFORMATION—DERATING CURVES Settings per Table 11 and Table 12.

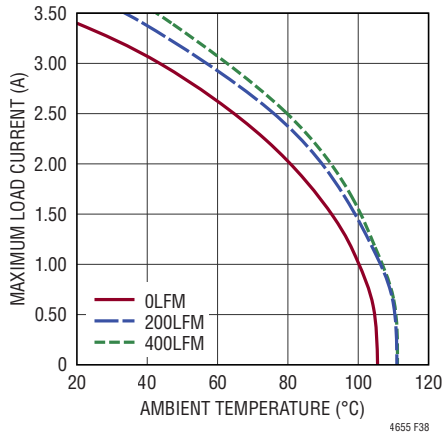

Figure 38. 12V to $-15V_{OUT}$ Derating Curve, with BGA Heat Sink

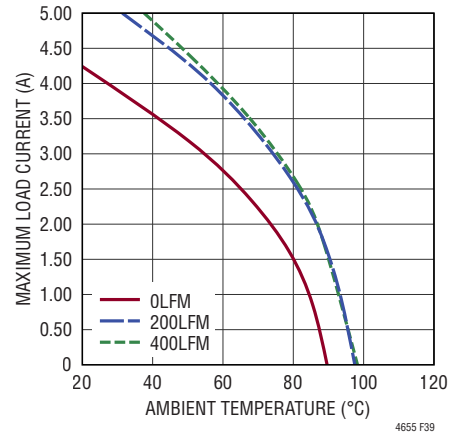

Figure 39. 24V to $-15V_{OUT}$ Derating Curve, with BGA Heat Sink

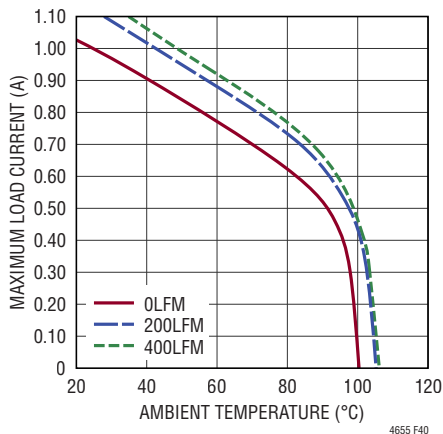

Figure 40. 5V to $-24V_{OUT}$ Derating Curve, No Heat Sink

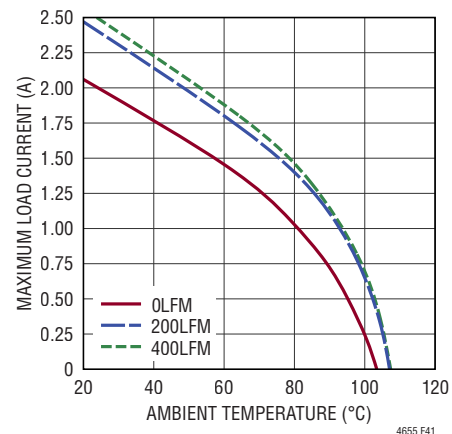

Figure 41. 12V to $-24V_{OUT}$ Derating Curve, No Heat Sink

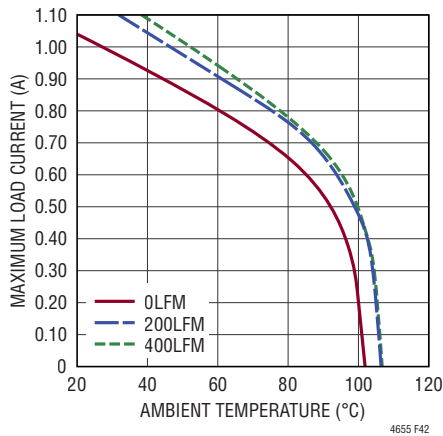

Figure 42. 5V to $-24V_{OUT}$ Derating Curve, with BGA Heat Sink

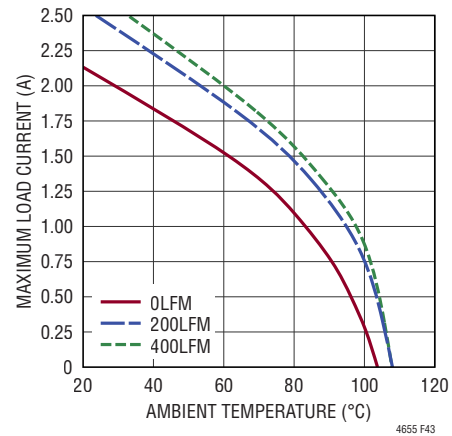

Figure 43. 12V to $-24V_{OUT}$ Derating Curve, with BGA Heat Sink

APPLICATIONS INFORMATION

Safety Considerations

The LTM4655 does not provide galvanic isolation from V_{INn} to V_{OUTn}^+/V_{OUTn}^- . There is no internal fuse. If required, a slow blow fuse with a rating twice the maximum input current needs to be provided to protect the unit from catastrophic failure.

The fuse or circuit breaker, if used, should be selected to limit the current to the regulator in case of a M_{Tn} MOSFET fault. If M_{Tn} fails, the system's input supply will source very large currents to V_{OUTn}^+ through M_{Tn} . This can cause excessive heat and board damage depending on how much power the input voltage can deliver to this system. A fuse or circuit breaker can be used as a secondary fault protector in this situation. Each channel of the LTM4655 features its own, independent overcurrent and overtemperature protection.

Layout Checklist/Example

The high integration of LTM4655 makes the PCB board layout straightforward. However, to optimize its electrical and thermal performance, some layout considerations are still necessary.

- Use large PCB copper areas for high current paths, including V_{INn} , V_{OUTn}^+ and V_{OUTn}^- . Doing so helps to minimize the PCB conduction loss and thermal stress.
- Place high frequency ceramic input and output (and, if used, input-to-output) capacitors next to the V_{INn} , V_{Dn} , V_{OUTn}^+/V_{OUTn}^- pins to minimize high frequency noise.
- Place a dedicated power ground layer underneath the LTM4655.
- To minimize the via conduction loss and reduce module thermal stress, use multiple vias for interconnection between top layer and other power layers.
- Do not put vias directly on pads, unless they are capped or plated over.
- For each channel, use a separate $S_{V_{OUTn}^-}$ copper plane for components connected to signal pins. Connect $S_{V_{OUTn}^-}$ to V_{OUTn}^- directly under the module.
- For parallel applications, connect the respective V_{OUTn}^+ , V_{OUTn}^- , V_{OSNSn}^+ , $RUNn$, $ISETna$, $COMPna$, $PGOODn$ and $IMONna$ pins, accordingly (see Figure 45).
- Bring out test points on the signal pins for monitoring.

Figure 44 gives a good example of the recommended LTM4655 layout.

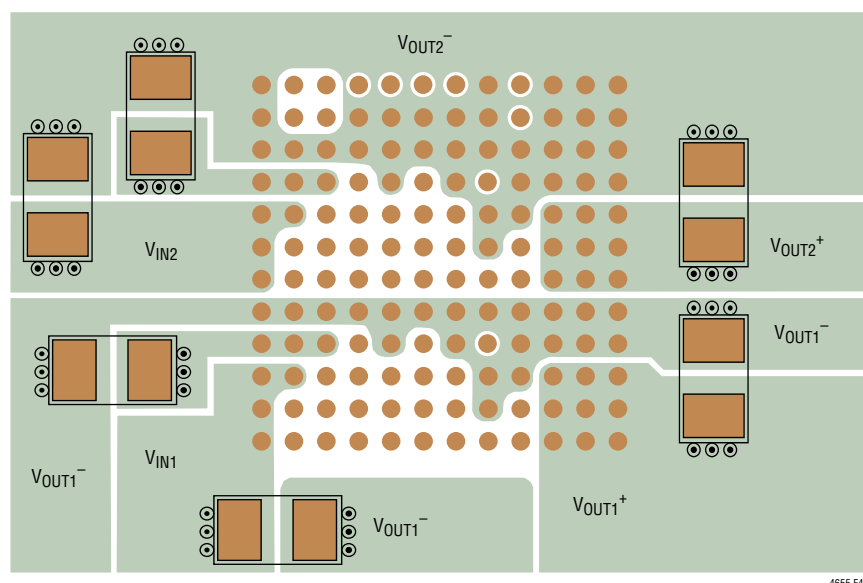
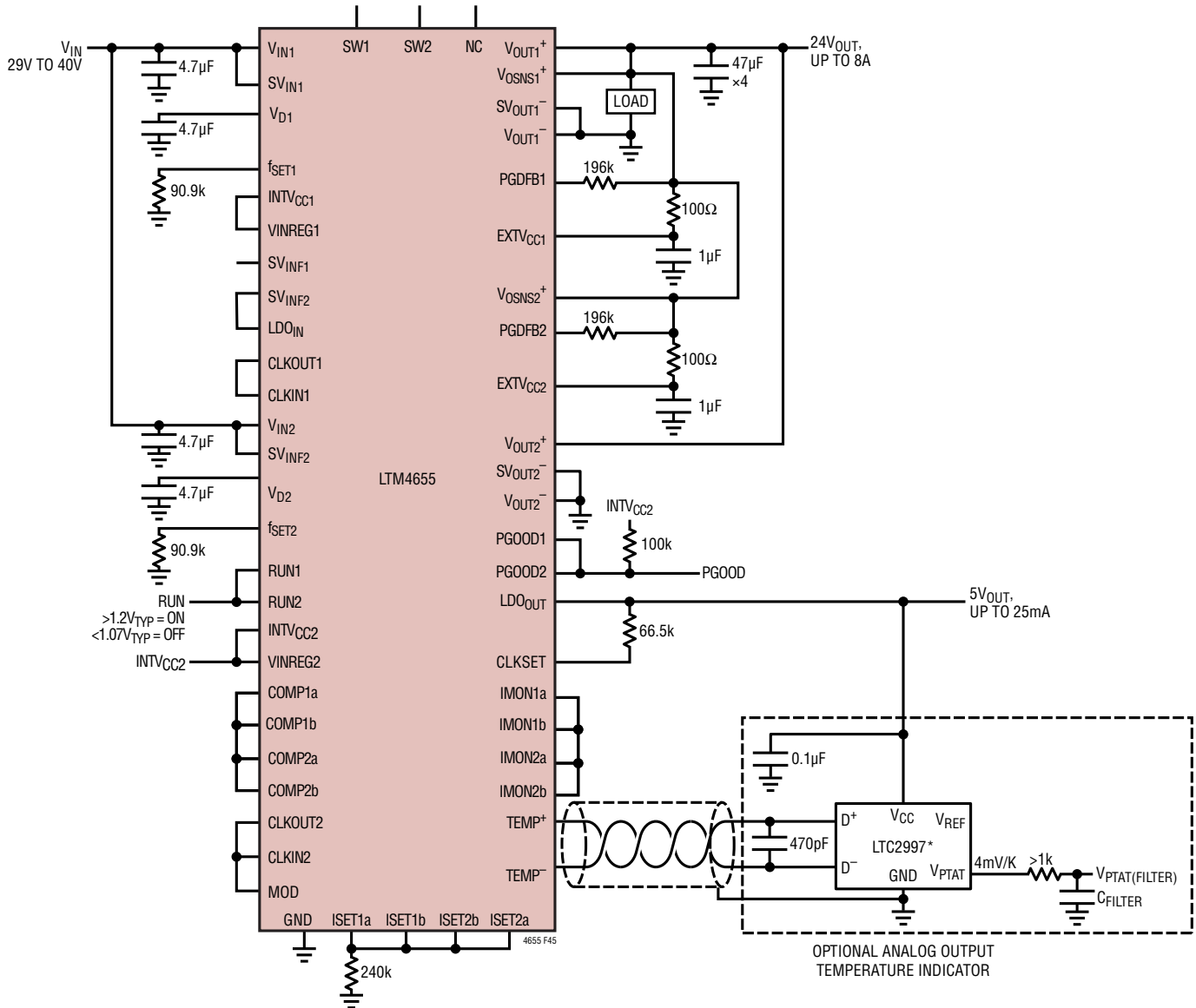

Figure 44. Recommended PCB Layout, Package Top View

4655 F44

TYPICAL APPLICATIONS



* PLACE 470pF DIRECTLY ACROSS THE LTC2997'S D⁺/D⁻ PINS.
 ROUTE TEMP⁺/TEMP⁻ DIFFERENTIALLY TO D⁺/D⁻ AND PROTECT FROM NOISE WITH GROUND SHIELDING.
 TERMINATE (CONNECT) THE D⁺/D⁻ GROUND SHIELD AT THE LTC2997 GND PIN, ONLY.
 FOR BEST V_{PTAT} PERFORMANCE, THE V_{CC} PIN OF THE LTC2997 MUST BE LOCALLY BYPASSED AND QUIET.
 SEE LTC2997 DATA SHEET AND APRIL 2017 LT JOURNAL TECHNICAL ARTICLES.

Figure 45. Single 8A, 24V Output DC/DC μModule Regulator with Optional Analog Temperature Indicator

TYPICAL APPLICATIONS

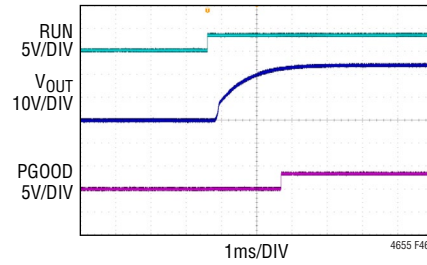

Figure 46. Start-Up Waveforms at $36V_{IN}$, Figure 45 Circuit

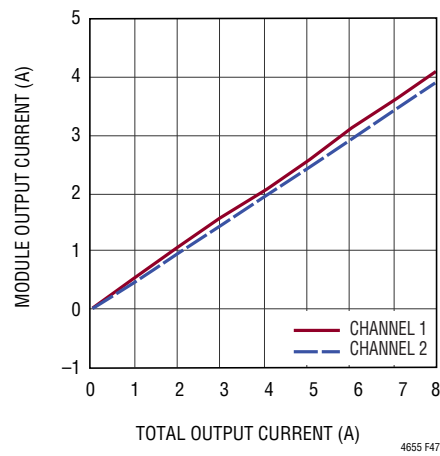
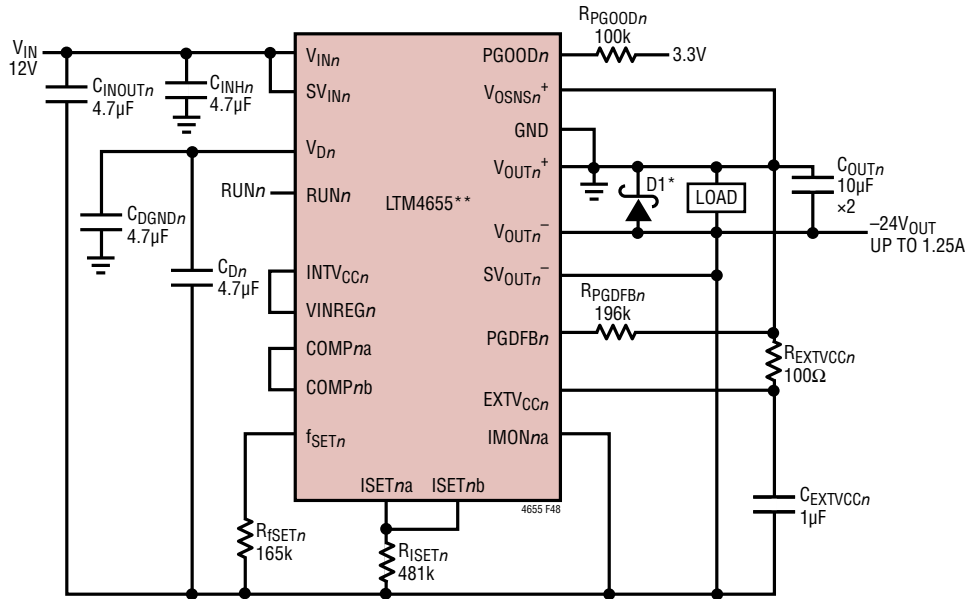

Figure 47. Current Sharing Performance of LTM4655 Channels in Figure 45 Circuit

TYPICAL APPLICATIONS



*D1 OPTIONAL (SEE EFFECT IN FIGURE 49): CENTRAL SEMICONDUCTOR P/N CMMSH1-40L
 **ONE CHANNEL SHOWN. PINS NOT USED AND NOT SHOWN IN THIS CIRCUIT: NC, SVINfn, IMONnb, LDOIN, LDOOUT, CLKSET, MOD, CLKOUTn, CLKINn, TEMP*, TEMP*

Figure 48. 1.25A, -24V Output DC/DC μModule Regulator

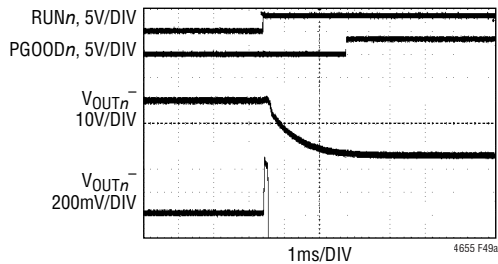

(a) Start-up Performance with D1 Not Installed. VOUTn- Reverse-Polarity at Start-Up Transiently Reaches 500mV

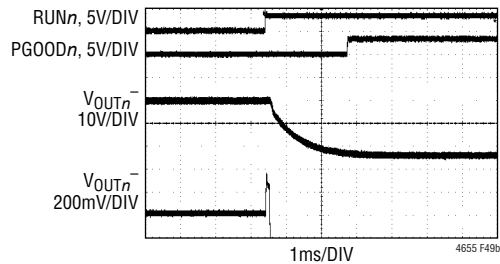

(b) Start-up Performance with D1 Installed. VOUTn- Reverse-Polarity at Start-Up is Transiently Limited to 360mV

Figure 49. Start-Up Waveforms at 12VIN, Figure 48 Circuit

TYPICAL APPLICATIONS

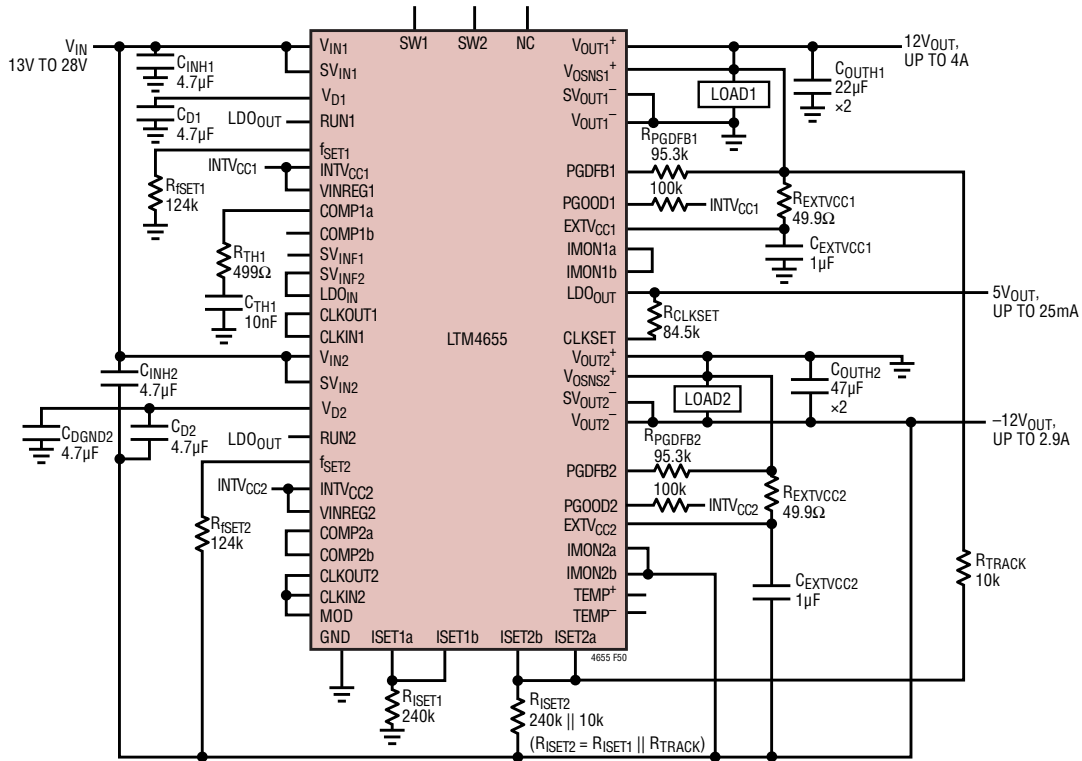

Figure 50. Concurrent ±12V Output DC/DC μModule Regulator

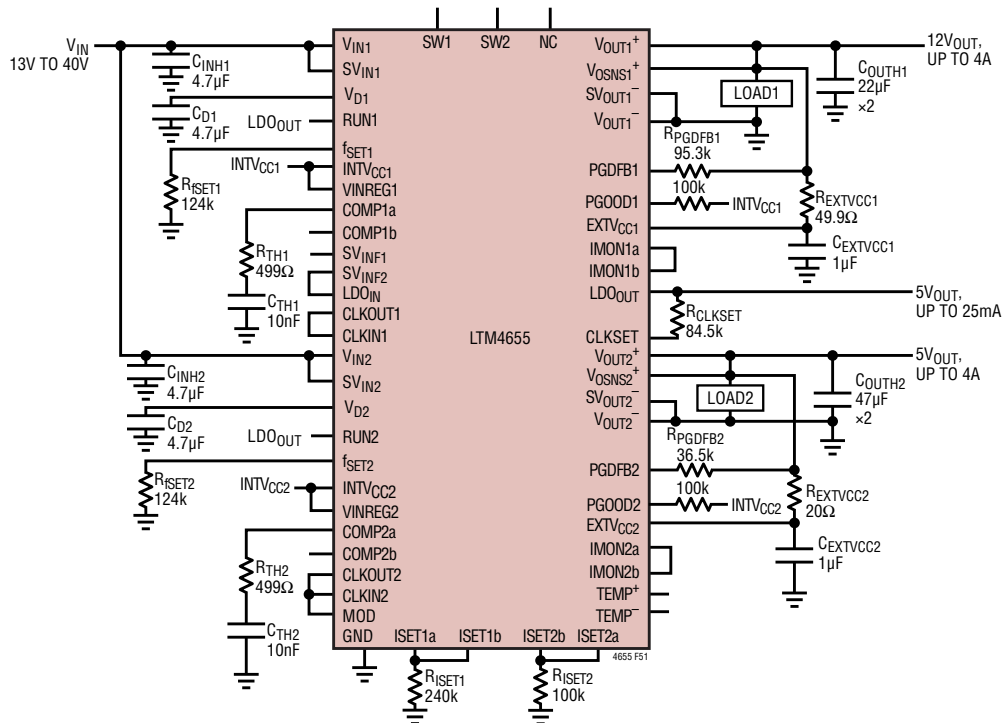
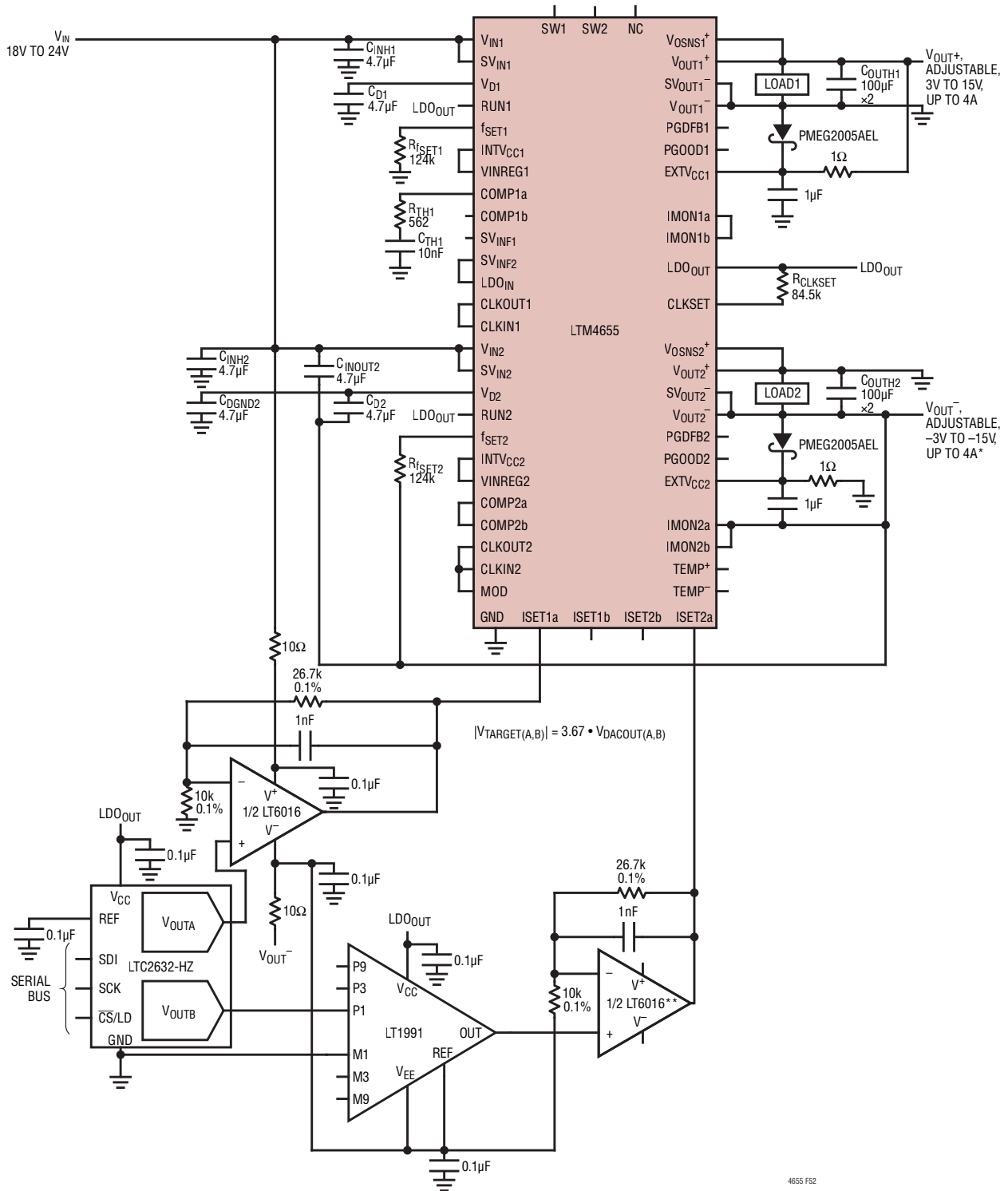

Figure 51. Dual 4A, 12V and 5V Output DC/DC μModule Regulator

TYPICAL APPLICATIONS



*SEE TABLE 6 AND APPLICATIONS INFORMATION SECTION FOR NEGATIVE OUTPUT CURRENT CAPABILITY
 **BOTH HALVES OF LT6016 ON SAME SUPPLY

Figure 52. A DAC-Controlled Bipolar-Output Programmable Power Supply

4655 F52

PACKAGE DESCRIPTION

Table 13. LTM4655 Component BGA Pinout

PIN ID	FUNCTION	PIN ID	FUNCTION	PIN ID	FUNCTION	PIN ID	FUNCTION	PIN ID	FUNCTION	PIN ID	FUNCTION
A1	V _{IN1}	B1	CLKIN1	C1	IMON1b	D1	PGOOD1	E1	COMP1b	F1	ISET1b
A2	V _{IN1}	B2	CLKOUT1	C2	IMON1a	D2	PGDFB1	E2	COMP1a	F2	ISET1a
A3	V _{IN1}	B3	V _{IN1}	C3	SV _{IN1}	D3	VINREG1	E3	f _{SET1}	F3	EXTV _{CC1}
A4	V _{D1}	B4	V _{D1}	C4	V _{D1}	D4	GND	E4	SV _{OUT1} ⁻	F4	RUN1
A5	V _{OUT1} ⁻	B5	V _{OUT1} ⁻	C5	V _{OUT1} ⁻	D5	V _{OUT1} ⁻	E5	V _{OUT1} ⁻	F5	V _{OUT1} ⁻
A6	V _{IN2}	B6	CLKIN2	C6	IMON2b	D6	PGOOD2	E6	COMP2b	F6	ISET2b
A7	V _{IN2}	B7	CLKOUT2	C7	IMON2a	D7	PGDFB2	E7	COMP2a	F7	ISET2a
A8	V _{IN2}	B8	V _{IN2}	C8	SV _{IN2}	D8	VINREG2	E8	f _{SET2}	F8	EXTV _{CC2}
A9	V _{D2}	B9	V _{D2}	C9	V _{D2}	D9	GND	E9	SV _{OUT2} ⁻	F9	RUN2
A10	V _{OUT2} ⁻	B10	V _{OUT2} ⁻	C10	V _{OUT2} ⁻	D10	V _{OUT2} ⁻	E10	V _{OUT2} ⁻	F10	V _{OUT2} ⁻
A11	V _{OUT2} ⁻	B11	SV _{INF1}	C11	SV _{INF2}	D11	V _{OUT2} ⁻	E11	V _{OUT2} ⁻	F11	V _{OUT2} ⁻
A12	V _{OUT2} ⁻	B12	LDO _{IN}	C12	CLKOUT2	D12	GND	E12	MOD	F12	CLKSET

PIN ID	FUNCTION	PIN ID	FUNCTION	PIN ID	FUNCTION	PIN ID	FUNCTION	PIN ID	FUNCTION	PIN ID	FUNCTION
G1	V _{OSNS1} ⁺	H1	V _{OSNS1} ⁺	J1	NC	K1	V _{OUT1} ⁺	L1	V _{OUT1} ⁺	M1	V _{OUT1} ⁺
G2	SV _{OUT1} ⁻	H2	SV _{OUT1} ⁻	J2	NC	K2	V _{OUT1} ⁺	L2	V _{OUT1} ⁺	M2	V _{OUT1} ⁺
G3	INTV _{CC1}	H3	V _{OUT1} ⁻	J3	V _{OUT1} ⁻	K3	V _{OUT1} ⁺	L3	V _{OUT1} ⁺	M3	V _{OUT1} ⁺
G4	V _{OUT1} ⁻	H4	SW1	J4	V _{OUT1} ⁻	K4	V _{OUT1} ⁻	L4	V _{OUT1} ⁻	M4	V _{OUT1} ⁻
G5	V _{OUT1} ⁻	H5	V _{OUT1} ⁻	J5	V _{OUT1} ⁻	K5	V _{OUT1} ⁻	L5	V _{OUT1} ⁻	M5	V _{OUT1} ⁻
G6	V _{OSNS2} ⁺	H6	V _{OSNS2} ⁺	J6	TEMP ⁺	K6	V _{OUT2} ⁺	L6	V _{OUT2} ⁺	M6	V _{OUT2} ⁺
G7	SV _{OUT2} ⁻	H7	SV _{OUT2} ⁻	J7	TEMP ⁻	K7	V _{OUT2} ⁺	L7	V _{OUT2} ⁺	M7	V _{OUT2} ⁺
G8	INTV _{CC2}	H8	V _{OUT2} ⁻	J8	V _{OUT2} ⁻	K8	V _{OUT2} ⁺	L8	V _{OUT2} ⁺	M8	V _{OUT2} ⁺
G9	V _{OUT2} ⁻	H9	SW2	J9	V _{OUT2} ⁻	K9	V _{OUT2} ⁻	L9	V _{OUT2} ⁻	M9	V _{OUT2} ⁻
G10	V _{OUT2} ⁻	H10	V _{OUT2} ⁻	J10	V _{OUT2} ⁻	K10	V _{OUT2} ⁻	L10	V _{OUT2} ⁻	M10	V _{OUT2} ⁻
G11	V _{OUT2} ⁻	H11	V _{OUT2} ⁻	J11	NC	K11	V _{OUT2} ⁻	L11	V _{OUT2} ⁻	M11	V _{OUT2} ⁻
G12	LDO _{OUT}	H12	V _{OUT2} ⁻	J12	NC	K12	V _{OUT2} ⁻	L12	V _{OUT2} ⁻	M12	V _{OUT2} ⁻

PACKAGE DESCRIPTION

BGA Package
144-Lead (16mm x 16mm x 5.01mm)
 (Reference DWG # 05-08-1551)

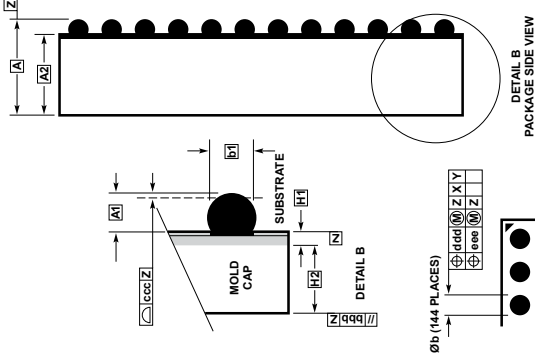
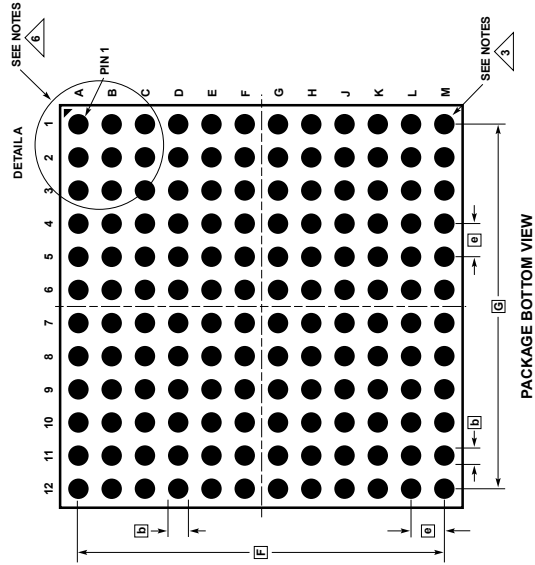

- NOTES:**
1. DIMENSIONING AND TOLERANCING PER ASME Y14.5M-1994
 2. ALL DIMENSIONS ARE IN MILLIMETERS. DRAWING NOT TO SCALE
 3. BALL DESIGNATION PER JEDEC MS-028 AND JEP95
 4. DETAILS OF PIN #1 IDENTIFIER ARE OPTIONAL, BUT MUST BE LOCATED WITHIN THE ZONE INDICATED. THE PIN #1 IDENTIFIER MAY BE EITHER A MOLD OR MARKED FEATURE
 5. PRIMARY DATUM -Z- IS SEATING PLANE
 6. PACKAGE ROW AND COLUMN LABELING MAY VARY AMONG μ Module PRODUCTS. REVIEW EACH PACKAGE LAYOUT CAREFULLY

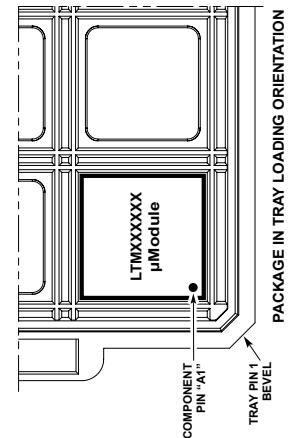

DIMENSIONS			
SYMBOL	MIN	NOM	MAX
A	4.81	5.01	5.21
A1	0.50	0.60	0.70
A2	4.31	4.41	4.51
b	0.60	0.75	0.90
b1	0.60	0.63	0.66
D		16.00	
E		16.00	
e		1.27	
F		13.97	
G		13.97	
H1	0.36	0.41	0.46
H2	3.95	4.00	4.05
aaa			0.15
bbb			0.10
ccc			0.20
ddd			0.30
eee			0.15
TOTAL NUMBER OF BALLS: 144			

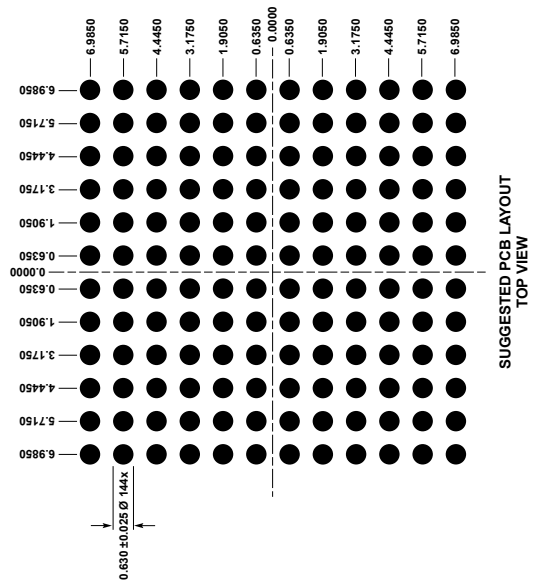

02-22-0223A

REVISION HISTORY

REV	DATE	DESCRIPTION	PAGE NUMBER
A	01/22	Reordered pin names according to pin number instead of function.	14-20
		Corrected SSFM acronym typo.	15
		Corrected CLKSET-supported switching frequency range and corresponding resistor-setting values.	19
		Corrected SW pin typo.	22
		Corrected pin name typos to indicate italic "n" subscript suffix, where missing.	23
		Clarified supported positive output voltage range.	25
		Fixed Equation 5 typo.	26
		Corrected numerical reference to Loop Compensation tables.	29
		Fixed typo referencing f_{SW} .	34
B	03/22	Amended POD.	54
		Added ink marking statement to package photos.	56

PACKAGE PHOTOS

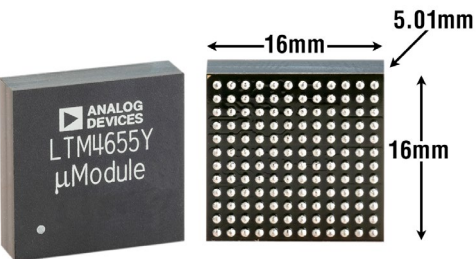

DESIGN RESOURCES

SUBJECT	DESCRIPTION
μModule Design and Manufacturing Resources	<p>Design:</p> <ul style="list-style-type: none"> • Selector Guides • Demo Boards and Gerber Files • Free Simulation Tools <p>Manufacturing:</p> <ul style="list-style-type: none"> • Quick Start Guide • PCB Design, Assembly and Manufacturing Guidelines • Package and Board Level Reliability
μModule Regulator Products Search	<ol style="list-style-type: none"> 1. Sort table of products by parameters and download the result as a spreadsheet. 2. Search using the Quick Power Search parametric table.
Digital Power System Management	<p>Analog Devices' family of digital power supply management ICs are highly integrated solutions that offer essential functions, including power supply monitoring, supervision, margining and sequencing, and feature EEPROM for storing user configurations and fault logging.</p>

RELATED PARTS

PART NUMBER	DESCRIPTION	COMMENTS
LTM4651	EN55022B Compliant 58V _{IN} , 24W Inverting-Output DC/DC μModule Regulator	3.6V ≤ V _{IN} ≤ 58V, -26.5V ≤ V _{OUT} ≤ -0.5V, I _{OUT} ≤ 4A, 15mm × 9mm × 5.01mm BGA
LTM4653	EN55022B Compliant 58V _{IN} , 4A Step-Down DC/DC μModule Regulator	3.1V ≤ V _{IN} ≤ 58V, 0.5V ≤ V _{OUT} ≤ 0.94V • V _{IN} , 15mm × 9mm × 5.01mm BGA
LTM8045	SEPIC or Inverting μModule DC/DC Converter	2.8V ≤ V _{IN} ≤ 18V, ±2.5V ≤ V _{OUT} ≤ ±15V, I _{OUT(DC)} ≤ 700mA, 6.25mm × 11.25mm × 4.92mm BGA
LTM8053	40V, Dual 3.5A Silent Switcher Step-Down μModule Regulator	3.4V ≤ V _{IN} ≤ 40V, 0.97V ≤ V _{OUT} ≤ 15V, 6.25mm × 9mm × 3.32mm BGA
LTM8024	40V, 3.5A Silent Switcher Step-Down μModule Regulator	3V ≤ V _{IN} ≤ 40V, 0.8V ≤ V _{OUT} ≤ 8V, 9mm × 11.25mm × 3.32mm BGA
LTM8049	Dual, SEPIC and/or Inverting μModule DC/DC Converter	2.6V ≤ V _{IN} ≤ 20V, ±2.5V ≤ V _{OUT} ≤ ±24V, I _{OUT(DC)} ≤ 1A/Channel, 9mm × 15mm × 2.42mm BGA
LTM8071	60V, 5A Silent Switcher® Step-Down μModule Regulator	3.6V ≤ V _{IN} ≤ 60V, 0.97V ≤ V _{OUT} ≤ 15V, 6.25mm × 9mm × 3.32mm BGA
LTM8073	60V, 3A Silent Switcher Step-Down μModule Regulator	3.4V ≤ V _{IN} ≤ 60V, 0.8V ≤ V _{OUT} ≤ 15V, 9mm × 11.25mm × 3.32mm BGA

Looking for pricing, stock, or lifecycle information?

Click below to explore more details on WIN SOURCE:

 [View LTM4655EY#PBF on WIN SOURCE](#)

 [Analog Devices Inc. Information](#)

Optimize Your Supply Chain with WIN SOURCE Solutions

-  Global Sourcing Solution
-  Obsolete Management
-  Cost Control Management
-  Shortage Management
-  Alternative Solution
-  Excess Inventory Management