



# THE DATASHEET OF DF02S-T



**1.0A SURFACE MOUNT GLASS PASSIVATED BRIDGE RECTIFIER**
**Features**

- Glass Passivated Die Construction
- Low Forward Voltage Drop, High Current Capability
- Surge Overload Rating to 50A Peak
- Designed for Surface Mount Application
- UL Listed Under Recognized Component Index, File Number E94661
- **Lead-Free Finish; RoHS Compliant (Notes 1 & 2)**
- **Halogen and Antimony Free. "Green" Device (Note 3)**

**Mechanical Data**

- Case: DF-S
- Case Material: Molded Plastic. UL Flammability Classification Rating 94V-0
- Moisture Sensitivity: Level 1 per J-STD-020
- Terminals: Finish - Tin. Solderable per MIL-STD-202, Method 208
- Polarity: As Marked on Case
- Weight: 0.38 grams (Approximate)

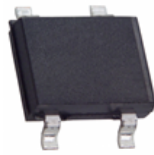

Top View

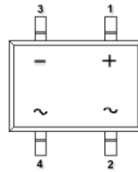

Pin Diagram

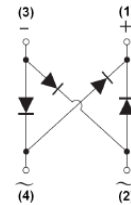

Internal Schematic

**Ordering Information** (Note 4)

Part Number	Case	Packaging
DFxS	DF-S	50/Tube
DFxS-T	DF-S	1500/Tape & Reel, 13-inch

- Notes:
1. EU Directive 2002/95/EC (RoHS) & 2011/65/EU (RoHS 2) compliant. All applicable RoHS exemptions applied.
  2. See [http://www.diodes.com/quality/lead\\_free.html](http://www.diodes.com/quality/lead_free.html) for more information about Diodes Incorporated's definitions of Halogen- and Antimony-free, "Green" and Lead-free.
  3. Halogen- and Antimony-free "Green" products are defined as those which contain <900ppm bromine, <900ppm chlorine (<1500ppm total Br + Cl) and <1000ppm antimony compounds.
  4. For packaging details, go to our website at <http://www.diodes.com/products/packages.html>.

**Marking Information**

- ⌋|| = Manufacturers' Code Marking
- DFxxxS = Product Type Marking Code, ex: DF10S
- YWW = Date Code Marking
- Y = Last Digit of Year (ex: 6 for 2016)
- WW = Week Code (01 to 52)

### Maximum Ratings (@T<sub>A</sub> = +25°C, unless otherwise specified.)

Single phase, half wave, 60Hz, resistive or inductive load.  
 For capacitive load, derate current by 20%.

Characteristic	Symbol	DF 005S	DF 01S	DF 02S	DF 04S	DF 06S	DF 08S	DF 10S	Unit
Peak Repetitive Reverse Voltage	V <sub>RMM</sub>	50	100	200	400	600	800	1000	V
Working Peak Reverse Voltage	V <sub>RWM</sub>								
DC Blocking Voltage	V <sub>R</sub>								
RMS Reverse Voltage	V <sub>RMS</sub>	35	70	140	280	420	560	700	V
Average Forward Rectified Current @ T <sub>A</sub> = +40°C	I <sub>O</sub>	1.0							A
Non-Repetitive Peak Forward Surge Current, 8.3 ms Single Half Sine-Wave Superimposed on Rated Load	I <sub>FSM</sub>	50							A

### Thermal Characteristics

Characteristic	Symbol	DF 005S	DF 01S	DF 02S	DF 04S	DF 06S	DF 08S	DF 10S	Unit
Typical Thermal Resistance, Junction to Ambient (Note 6)	R <sub>θJA</sub>	40							°C/W
Operating and Storage Temperature Range	T <sub>J</sub> , T <sub>STG</sub>	-65 to +150							°C

### Electrical Characteristics (@T<sub>A</sub> = +25°C, unless otherwise specified.)

Characteristic	Symbol	DF 005S	DF 01S	DF 02S	DF 04S	DF 06S	DF 08S	DF 10S	Unit
Forward Voltage (Per Element) @ I <sub>F</sub> = 1.0A	V <sub>FM</sub>	1.1							V
Peak Reverse Current at Rated @ T <sub>A</sub> = +25°C	I <sub>RM</sub>	10							μA
DC Blocking Voltage (Per Element) @ T <sub>A</sub> = +125°C		500							
I <sup>2</sup> t Rating for Fusing (t<8.3ms)	I <sup>2</sup> t	10.4							A <sup>2</sup> s
Typical Total Capacitance (Per Element) (Note 5)	C <sub>T</sub>	25							pF

Notes: 5. Measured at 1.0 MHz and applied reverse voltage of 4.0V DC.  
 6. Thermal resistance, junction to ambient, measured on PC board with 5.0mm<sup>2</sup> (0.03mm thick) land areas.

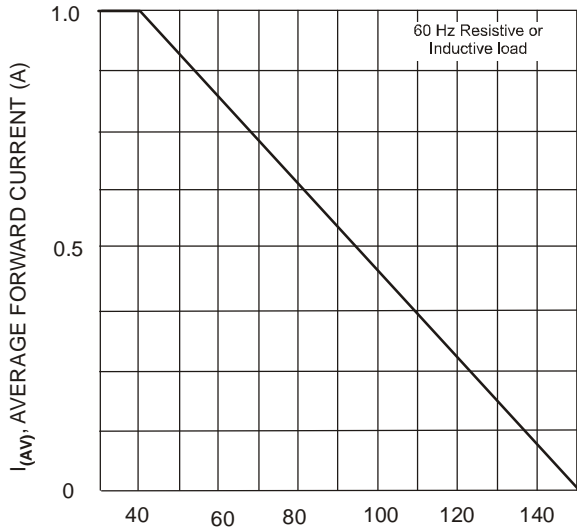

$T_A$ , AMBIENT TEMPERATURE (°C)  
Fig. 1 Output Current Derating Curve

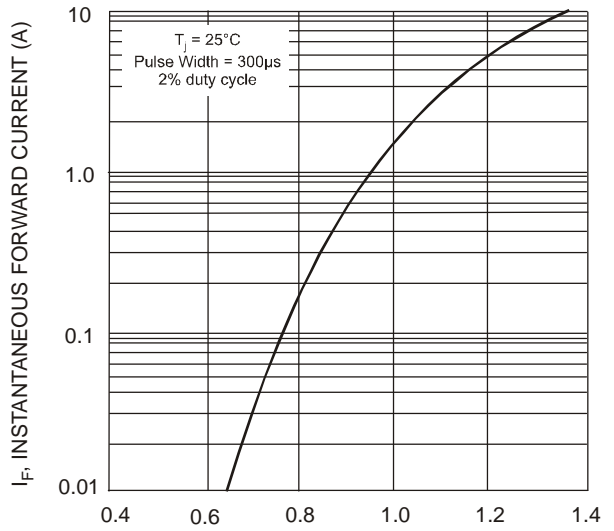

$V_F$ , INSTANTANEOUS FORWARD VOLTAGE (V)  
Fig. 2 Typical Forward Characteristics (per element)

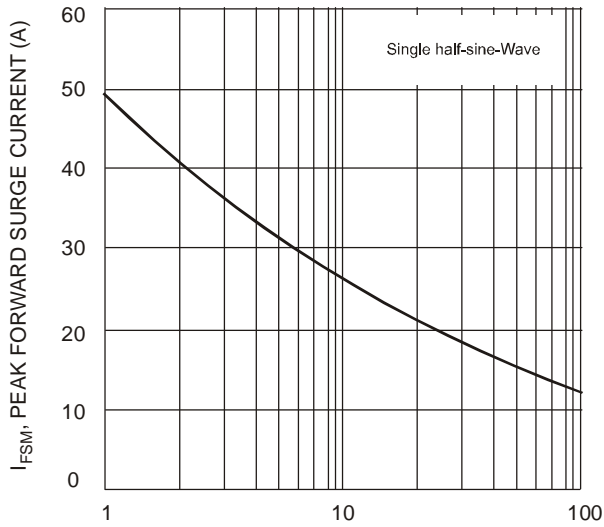

NUMBER OF CYCLES AT 60 Hz  
Fig. 3 Max Non-Repetitive Peak Forward Surge Current

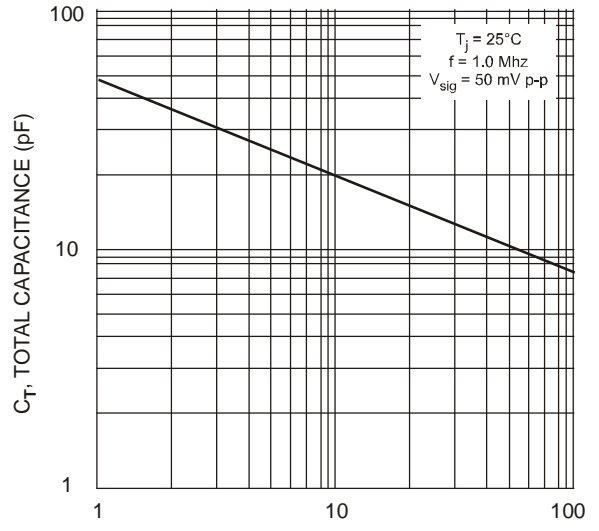

$V_R$ , REVERSE VOLTAGE (V)  
Fig. 4 Typical Total Capacitance (per element)

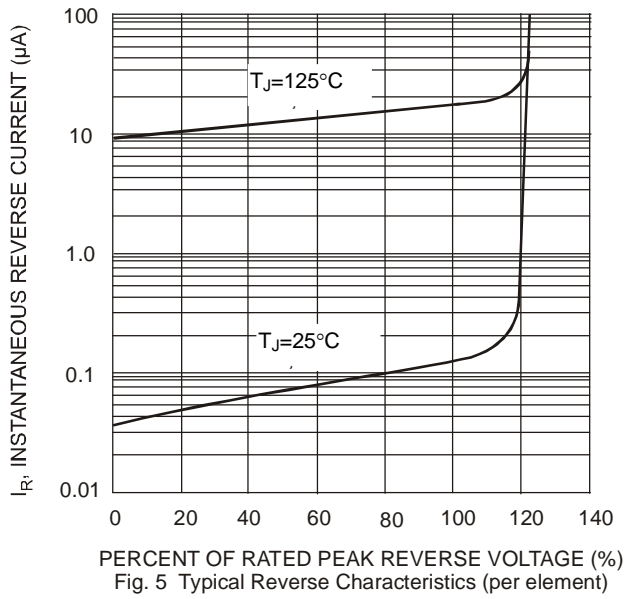

**Package Outline Dimensions**

Please see <http://www.diodes.com/package-outlines.html> for the latest version.

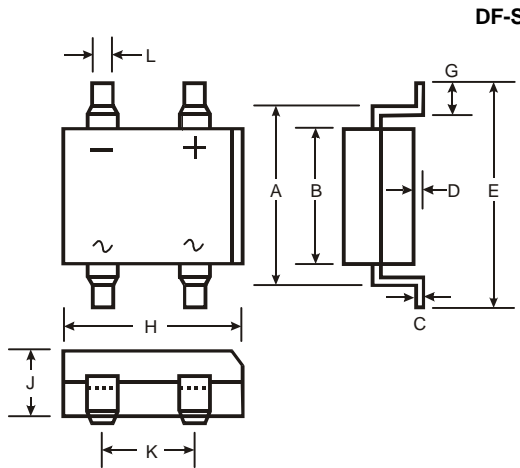

DF-S		
Dim	Min	Max
A	7.40	7.90
B	6.20	6.50
C	0.22	0.30
D	0.076	0.33
E	—	10.40
G	1.02	1.53
H	8.13	8.51
J	2.40	2.60
K	5.00	5.20
L	1.00	1.20
All Dimensions in mm		

**Suggested Pad Layout**

Please see <http://www.diodes.com/package-outlines.html> for the latest version.

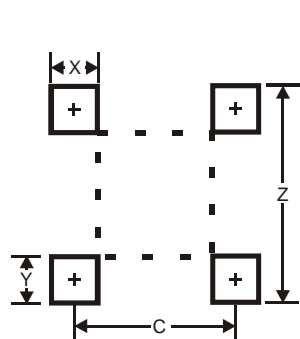

Dimensions	Value (in mm)
Z	10.26
X	1.2
Y	1.52
C	5.2

**IMPORTANT NOTICE**

DIODES INCORPORATED MAKES NO WARRANTY OF ANY KIND, EXPRESS OR IMPLIED, WITH REGARDS TO THIS DOCUMENT, INCLUDING, BUT NOT LIMITED TO, THE IMPLIED WARRANTIES OF MERCHANTABILITY AND FITNESS FOR A PARTICULAR PURPOSE (AND THEIR EQUIVALENTS UNDER THE LAWS OF ANY JURISDICTION).

Diodes Incorporated and its subsidiaries reserve the right to make modifications, enhancements, improvements, corrections or other changes without further notice to this document and any product described herein. Diodes Incorporated does not assume any liability arising out of the application or use of this document or any product described herein; neither does Diodes Incorporated convey any license under its patent or trademark rights, nor the rights of others. Any Customer or user of this document or products described herein in such applications shall assume all risks of such use and will agree to hold Diodes Incorporated and all the companies whose products are represented on Diodes Incorporated website, harmless against all damages.

Diodes Incorporated does not warrant or accept any liability whatsoever in respect of any products purchased through unauthorized sales channel. Should Customers purchase or use Diodes Incorporated products for any unintended or unauthorized application, Customers shall indemnify and hold Diodes Incorporated and its representatives harmless against all claims, damages, expenses, and attorney fees arising out of, directly or indirectly, any claim of personal injury or death associated with such unintended or unauthorized application.

Products described herein may be covered by one or more United States, international or foreign patents pending. Product names and markings noted herein may also be covered by one or more United States, international or foreign trademarks.

This document is written in English but may be translated into multiple languages for reference. Only the English version of this document is the final and determinative format released by Diodes Incorporated.

**LIFE SUPPORT**

Diodes Incorporated products are specifically not authorized for use as critical components in life support devices or systems without the express written approval of the Chief Executive Officer of Diodes Incorporated. As used herein:

A. Life support devices or systems are devices or systems which:

1. are intended to implant into the body, or
2. support or sustain life and whose failure to perform when properly used in accordance with instructions for use provided in the labeling can be reasonably expected to result in significant injury to the user.

B. A critical component is any component in a life support device or system whose failure to perform can be reasonably expected to cause the failure of the life support device or to affect its safety or effectiveness.

Customers represent that they have all necessary expertise in the safety and regulatory ramifications of their life support devices or systems, and acknowledge and agree that they are solely responsible for all legal, regulatory and safety-related requirements concerning their products and any use of Diodes Incorporated products in such safety-critical, life support devices or systems, notwithstanding any devices- or systems-related information or support that may be provided by Diodes Incorporated. Further, Customers must fully indemnify Diodes Incorporated and its representatives against any damages arising out of the use of Diodes Incorporated products in such safety-critical, life support devices or systems.

Copyright © 2016, Diodes Incorporated

[www.diodes.com](http://www.diodes.com)

## Looking for pricing, stock, or lifecycle information?

Click below to explore more details on WIN SOURCE:

- [View DF02S-T on WIN SOURCE](#)
- [Diodes Incorporated Information](#)

## Optimize Your Supply Chain with WIN SOURCE Solutions

- ✓ Global Sourcing Solution
- ✓ Obsolete Management
- ✓ Cost Control Management
- ✓ Shortage Management
- ✓ Alternative Solution
- ✓ Excess Inventory Management