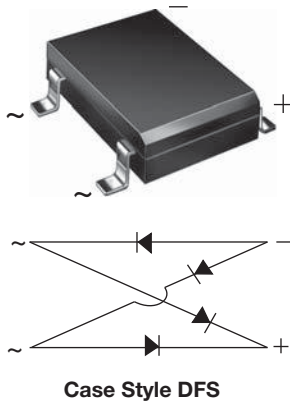




**THE DATASHEET OF
DF02S-E3/77**



Miniature Glass Passivated Single-Phase Surface Mount Bridge Rectifiers



FEATURES

- UL recognition, file number E54214
- Ideal for automated placement
- High surge current capability
- Meets MSL level 1, per J-STD-020, LF maximum peak of 260 °C
- Material categorization: For definitions of compliance please see www.vishay.com/doc?99912



RoHS
COMPLIANT

TYPICAL APPLICATIONS

General purpose use in AC/DC bridge full wave rectification for SMPS, lighting ballaster, adapter, battery charger, home appliances, office equipment, and telecommunication applications.

MECHANICAL DATA

Case: DFS

Molding compound meets UL 94 V-0 flammability rating
 Base P/N-E3 - RoHS-compliant, commercial grade

Terminals: Matte tin plated leads, solderable per J-STD-002 and JESD22-B102

E3 suffix meets JESD 201 class 1A whisker test

Polarity: As marked on body

PRIMARY CHARACTERISTICS	
Package	DFS
$I_{F(AV)}$	1 A
V_{RRM}	50 V, 100 V, 200 V, 400 V, 600 V, 800 V, 1000 V
I_{FSM}	50 A
I_R	5 μ A
V_F at $I_F = 1.0$ A	1.1 V
T_J max.	150 °C
Diode variations	Quad

MAXIMUM RATINGS ($T_A = 25$ °C unless otherwise noted)									
PARAMETER	SYMBOL	DF005S	DF01S	DF02S	DF04S	DF06S	DF08S	DF10S	UNIT
Device marking code		DF005S	DF01S	DF02S	DF04S	DF06S	DF08S	DF10S	
Maximum repetitive peak reverse voltage	V_{RRM}	50	100	200	400	600	800	1000	V
Maximum RMS voltage	V_{RMS}	35	70	140	280	420	560	700	V
Maximum DC blocking voltage	V_{DC}	50	100	200	400	600	800	1000	V
Maximum average forward output rectified current at $T_A = 40$ °C ⁽¹⁾	$I_{F(AV)}$	1.0							A
Peak forward surge current single half sine-wave superimposed on rated load	I_{FSM}	50							A
Rating for fusing ($t < 8.3$ ms)	I^2t	10							A ² s
Operating junction and storage temperature range	T_J, T_{STG}	- 55 to + 150							°C

Note

⁽¹⁾ Units mounted on PCB with 0.51" x 0.51" (13 mm x 13 mm) copper pads

ELECTRICAL CHARACTERISTICS ($T_A = 25$ °C unless otherwise noted)										
PARAMETER	TEST CONDITIONS	SYMBOL	DF005S	DF01S	DF02S	DF04S	DF06S	DF08S	DF10S	UNIT
Maximum instantaneous forward voltage drop per diode	1.0 A	V_F	1.1							V
Maximum DC reverse current at rated DC blocking voltage per diode	$T_A = 25$ °C	I_R	5.0							μ A
	$T_A = 125$ °C		500							
Typical junction capacitance per diode ⁽¹⁾		C_J	25							pF

Note

⁽¹⁾ Measured at 1.0 MHz and applied reverse voltage of 4.0 V

THERMAL CHARACTERISTICS ($T_A = 25\text{ }^\circ\text{C}$ unless otherwise noted)										
PARAMETER	SYMBOL	DF005S	DF01S	DF02S	DF04S	DF06S	DF08S	DF10S	UNIT	
Typical thermal resistance ⁽¹⁾	$R_{\theta JA}$					40				$^\circ\text{C/W}$
	$R_{\theta JL}$					15				

Note

⁽¹⁾ Units mounted on PCB with 0.51" x 0.51" (13 mm x 13 mm) copper pads

ORDERING INFORMATION (Example)				
PREFERRED P/N	UNIT WEIGHT (g)	PREFERRED PACKAGE CODE	BASE QUANTITY	DELIVERY MODE
DF06S-E3/45	0.399	45	50	Tube
DF06S-E3/77	0.399	77	1500	13" diameter paper tape and reel

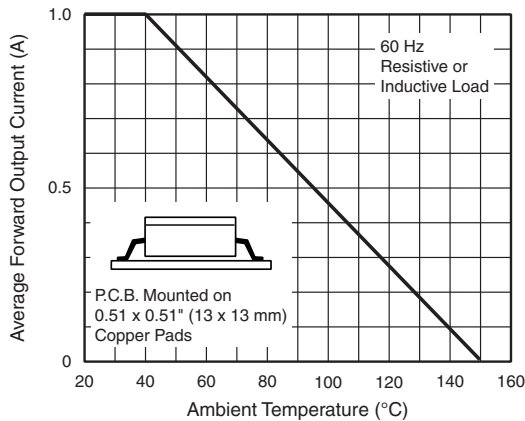
RATINGS AND CHARACTERISTICS CURVES ($T_A = 25\text{ }^\circ\text{C}$ unless otherwise noted)


Fig. 1 - Derating Curve Output Rectified Current

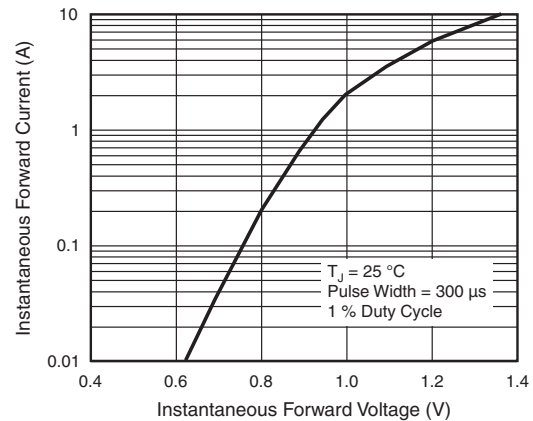


Fig. 3 - Typical Forward Characteristics Per Diode

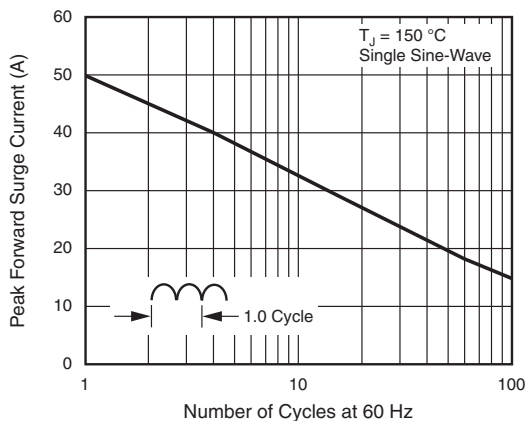


Fig. 2 - Maximum Non-Repetitive Peak Forward Surge Current Per Diode

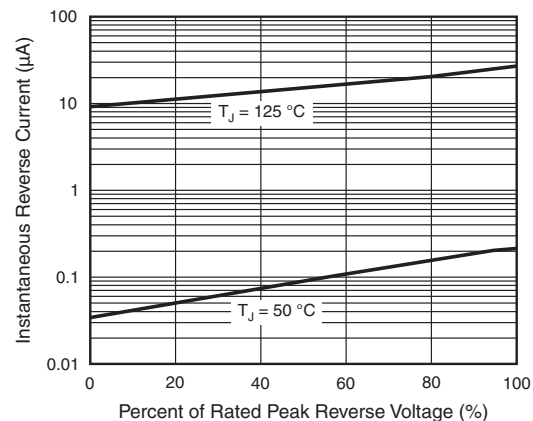


Fig. 4 - Typical Reverse Leakage Characteristics Per Diode

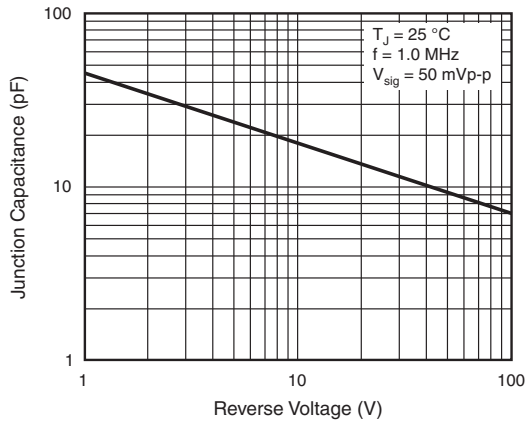


Fig. 5 - Typical Junction Capacitance Per Diode

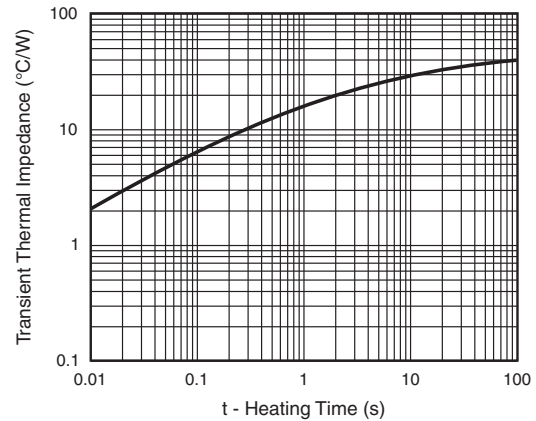
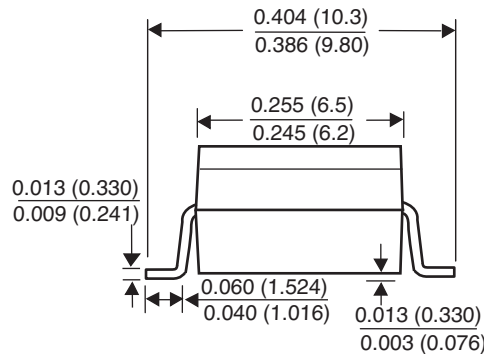
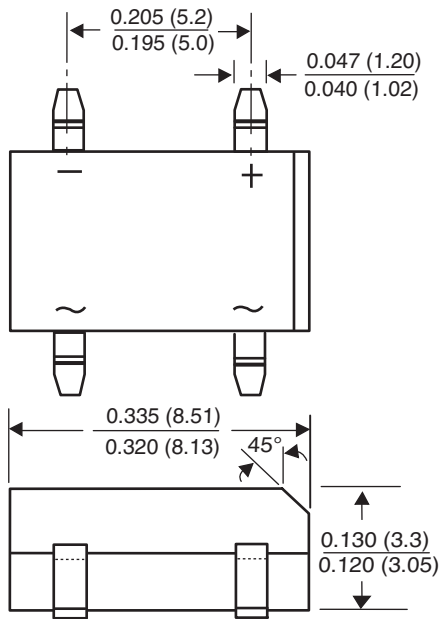


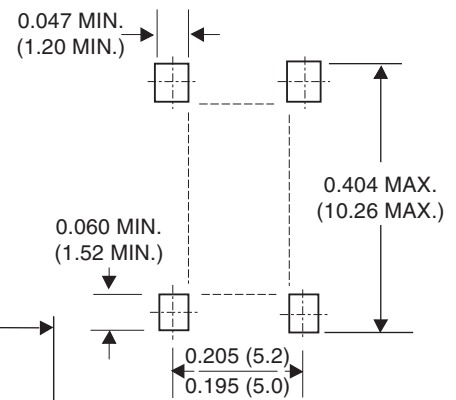
Fig. 6 - Typical Transient Thermal Impedance

PACKAGE OUTLINE DIMENSIONS in inches (millimeters)

Case Style DFS



Mounting Pad Layout





Disclaimer

ALL PRODUCT, PRODUCT SPECIFICATIONS AND DATA ARE SUBJECT TO CHANGE WITHOUT NOTICE TO IMPROVE RELIABILITY, FUNCTION OR DESIGN OR OTHERWISE.

Vishay Intertechnology, Inc., its affiliates, agents, and employees, and all persons acting on its or their behalf (collectively, "Vishay"), disclaim any and all liability for any errors, inaccuracies or incompleteness contained in any datasheet or in any other disclosure relating to any product.

Vishay makes no warranty, representation or guarantee regarding the suitability of the products for any particular purpose or the continuing production of any product. To the maximum extent permitted by applicable law, Vishay disclaims (i) any and all liability arising out of the application or use of any product, (ii) any and all liability, including without limitation special, consequential or incidental damages, and (iii) any and all implied warranties, including warranties of fitness for particular purpose, non-infringement and merchantability.

Statements regarding the suitability of products for certain types of applications are based on Vishay's knowledge of typical requirements that are often placed on Vishay products in generic applications. Such statements are not binding statements about the suitability of products for a particular application. It is the customer's responsibility to validate that a particular product with the properties described in the product specification is suitable for use in a particular application. Parameters provided in datasheets and / or specifications may vary in different applications and performance may vary over time. All operating parameters, including typical parameters, must be validated for each customer application by the customer's technical experts. Product specifications do not expand or otherwise modify Vishay's terms and conditions of purchase, including but not limited to the warranty expressed therein.

Except as expressly indicated in writing, Vishay products are not designed for use in medical, life-saving, or life-sustaining applications or for any other application in which the failure of the Vishay product could result in personal injury or death. Customers using or selling Vishay products not expressly indicated for use in such applications do so at their own risk. Please contact authorized Vishay personnel to obtain written terms and conditions regarding products designed for such applications.

No license, express or implied, by estoppel or otherwise, to any intellectual property rights is granted by this document or by any conduct of Vishay. Product names and markings noted herein may be trademarks of their respective owners.

Looking for pricing, stock, or lifecycle information?

Click below to explore more details on WIN SOURCE:

 [View DF02S-E3/77 on WIN SOURCE](#)

 [Vishay Information](#)

Optimize Your Supply Chain with WIN SOURCE Solutions

-  Global Sourcing Solution
-  Obsolete Management
-  Cost Control Management
-  Shortage Management
-  Alternative Solution
-  Excess Inventory Management