



**THE DATASHEET OF
FN283-4-06**



Compact filtered power entry module



- Complies with IEC/EN 60601-1
- Rated currents up to 10 A
- Single or dual-fuse holder
- Fuses $\varnothing 5 \times 20$ mm
- 2-pole rocker switch
- General purpose application
- Optional earth line choke (E type)
- Optional medical versions (B type)

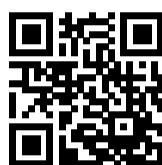

Performance indicators

Attenuation performance



Rated current [A]



Technical Specifications

Maximum continuous operating voltage	250 VOLT, 50/60 Hz
Rated currents	1 to 10 A @ 40°C max
Operating frequency	DC to 400 Hz
High potential test voltage	P → PE 2000 VAC for 2 sec (standard types) P → PE 2500 VAC for 2 sec (B types) P → N 760 VAC for 2 sec
Temperature range (operation and storage)	-25°C to +85°C (25/85/21)
Protection category	IP 40 according to IEC 60529
Flammability corresponding to	UL 94 V-2 or better
Design corresponding to	UL 1283, CSA 22.2 No. 8 1986, IEC/EN 60939
Fuse holder	1 or 2 fuses ($\varnothing 5 \times 20$ mm) (certified to IEC 60127-6), power acceptance 1.6W @ Ta 23°C per pole for 2 fuses. 2.5W, if only 1 pole is used.
Marking	Marking max. 250 V ~ (text is print. below fuse symbol)
Rocker switch description	
Switch ratings	
Function	2-pole, dark not illuminated Marking I - 0
Electrical specifications	Inrush current 82 A 6,000 on-off operations according to UL 1054, TV5 10,000 on-off operations according to ENEC
Europe (ENEC)	10 A (4 A), 250 VAC*
USA (UL) and Canada (C-UL)	10 A, 125 VAC 10 A, 250 VAC 1/3 HP

* Value in () relates to the inductive current charge: $\cos(\phi) = 0.65$

Approvals & Compliances



(CQC except HI-types)

Features and Benefits

- High conducted attenuation performance, based on chokes with high saturation resistance and excellent thermal behavior
- Rear/front or snap-in mounting
- Single or dual-fuse holder
- 2-pole rocker switch
- Custom-specific versions are available on request

Typical Applications

- Portable electrical and electronic equipment
- Consumer goods
- EDP and office equipment
- Single-phase power supplies, switch-mode power supplies
- Test and measurement equipment
- Medical equipment

Typical electrical schematic

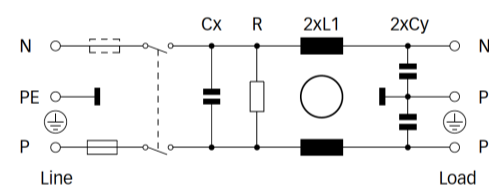

E types

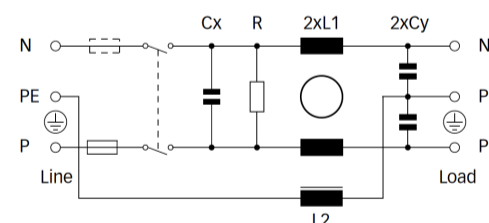

Filter Selection Table

Filter	Rated current @ 40°C (25°C) [A]	Leakage current* @ 230 VAC/50 Hz [µA]	Inductance**		Capacitance**		Resistance** R [kΩ]	Output connections	Fuses*** [Qty]	Weight [g]
			L1 [mH]	L2 [mH]	Cx [nF]	Cy [nF]				
FN 281-1-06	1 (1.2)	373	7.5		220	2.2	1000	-06	1	90
FN 281-2-06	2 (2.4)	373	2		220	2.2	1000	-06	1	90
FN 281-4-06	4 (4.8)	373	1		220	2.2	1000	-06	1	90
FN 281-6-06	6 (7.2)	373	0.45		220	2.2	1000	-06	1	90
FN 281-10-06	10 (11.6)	373	0.34		220	2.2	1000	-06	1	90
FN 282-1-06	1 (1.2)	373	7.5		220	2.2	1000	-06	2	90
FN 282-2-06	2 (2.4)	373	2		220	2.2	1000	-06	2	90
FN 282-4-06	4 (4.8)	373	1		220	2.2	1000	-06	2	90
FN 282-6-06	6 (7.2)	373	0.45		220	2.2	1000	-06	2	90
FN 282-10-06	10 (11.6)	373	0.34		220	2.2	1000	-06	2	90
FN 283-1-06	1 (1.2)	373	7.5		220	2.2	1000	-06	1	90
FN 283-2-06	2 (2.4)	373	2		220	2.2	1000	-06	1	90
FN 283-4-06	4 (4.8)	373	1		220	2.2	1000	-06	1	90
FN 283-6-06	6 (7.2)	373	0.45		220	2.2	1000	-06	1	90
FN 283-10-06	10 (11.6)	373	0.34		220	2.2	1000	-06	1	90
FN 284-1-06	1 (1.2)	373	7.5		220	2.2	1000	-06	2	90
FN 284-2-06	2 (2.4)	373	2		220	2.2	1000	-06	2	90
FN 284-4-06	4 (4.8)	373	1		220	2.2	1000	-06	2	90
FN 284-6-06	6 (7.2)	373	0.45		220	2.2	1000	-06	2	90
FN 284-10-06	10 (11.6)	373	0.34		220	2.2	1000	-06	2	90
FN 285-1-06	1 (1.2)	373	7.5		220	2.2	1000	-06	1	90
FN 285-2-06	2 (2.4)	373	2		220	2.2	1000	-06	1	90
FN 285-4-06	4 (4.8)	373	1		220	2.2	1000	-06	1	90
FN 285-6-06	6 (7.2)	373	0.45		220	2.2	1000	-06	1	90
FN 285-10-06	10 (11.6)	373	0.34		220	2.2	1000	-06	1	90
FN 286-1-06	1 (1.2)	373	7.5		220	2.2	1000	-06	2	90
FN 286-2-06	2 (2.4)	373	2		220	2.2	1000	-06	2	90
FN 286-4-06	4 (4.8)	373	1		220	2.2	1000	-06	2	90
FN 286-6-06	6 (7.2)	373	0.45		220	2.2	1000	-06	2	90
FN 286-10-06	10 (11.6)	373	0.34		220	2.2	1000	-06	2	90
FN 283 E-1-06	1 (1.2)	373	7.5	0.4	220	2.2	1000	-06	1	100
FN 283 E-2-06	2 (2.4)	373	2	0.4	220	2.2	1000	-06	1	100
FN 283 E-4-06	4 (4.8)	373	1	0.4	220	2.2	1000	-06	1	100
FN 283 E-6-06	6 (7.2)	373	0.45	0.4	220	2.2	1000	-06	1	100
FN 284 E-1-06	1 (1.2)	373	7.5	0.4	220	2.2	1000	-06	2	100
FN 284 E-2-06	2 (2.4)	373	2	0.4	220	2.2	1000	-06	2	100
FN 284 E-4-06	4 (4.8)	373	1	0.4	220	2.2	1000	-06	2	100
FN 284 E-6-06	6 (7.2)	373	0.45	0.4	220	2.2	1000	-06	2	100
FN 282 B-1-06	1 (1.2)	2	7.5		220		1000	-06	2	90
FN 282 B-2-06	2 (2.4)	2	2		220		1000	-06	2	90
FN 282 B-4-06	4 (4.8)	2	1		220		1000	-06	2	90
FN 282 B-6-06	6 (7.2)	2	0.45		220		1000	-06	2	90
FN 282 B-10-06	10 (11.6)	2	0.34		220		1000	-06	2	90

* Maximum leakage under normal operating conditions. Note: if the neutral line is interrupted, worst case leakage could reach twice this level.

** Tolerances apply: Inductance: -30/+50%, Capacitance: ±20%, Resistance: ±10%

*** Filters are delivered without fuse.

Filter	Rated current @ 40°C (25°C) [A]	Leakage current* @ 230 VAC/50 Hz [µA]	Inductance**		Capacitance**		Resistance** R [kΩ]	Output connections	Fuses*** [Qty]	Weight [g]
			L1 [mH]	L2 [mH]	Cx [nF]	Cy [nF]				
FN 284 B-1-06	1 (1.2)	2	7.5		220		1000	-06	2	90
FN 284 B-2-06	2 (2.4)	2	2		220		1000	-06	2	90
FN 284 B-4-06	4 (4.8)	2	1		220		1000	-06	2	90
FN 284 B-6-06	6 (7.2)	2	0.45		220		1000	-06	2	90
FN 284 B-10-06	10 (11.6)	2	0.34		220		1000	-06	2	90
FN 286 B-1-06	1 (1.2)	2	7.5		220		1000	-06	2	90
FN 286 B-2-06	2 (2.4)	2	2		220		1000	-06	2	90
FN 286 B-4-06	4 (4.8)	2	1		220		1000	-06	2	90
FN 286 B-6-06	6 (7.2)	2	0.45		220		1000	-06	2	90
FN 286 B-10-06	10 (11.6)	2	0.34		220		1000	-06	2	90

* Maximum leakage under normal operating conditions. Note: if the neutral line is interrupted, worst case leakage could reach twice this level.

** Tolerances apply: Inductance: -30/+50%, Capacitance: ±20%, Resistance: ±10%

*** Filters are delivered without fuse.

Product selector

FN 28xx-yy-zz

- 06: Faston 6.3 x 0.8mm (spade/soldering)
- 1 to 10: Rated current
- Blank: Standard version
- E: Optional earth line choke
- B: Medical version (with bleed resistor and without Y2-capacitor)
- 1: Flange mounting version top/bottom, single-fuse
- 2: Flange mounting version top/bottom, dual-fuse
- 3: Flange mounting version left/right, single-fuse
- 4: Flange mounting version left/right, dual-fuse
- 5: Snap-in version, single-fuse
- 6: Snap-in version, dual-fuse

For example: FN 281-6-06, FN 283 B-04-06, FN 283 E-1-06

Typical Filter Attenuation

Per CISPR 17; A=50 Ω/50 Ω sym; B=50 Ω/50 Ω asym; C=0.1 Ω/100 Ω sym; D=100 Ω/0.1 Ω sym

1 A types

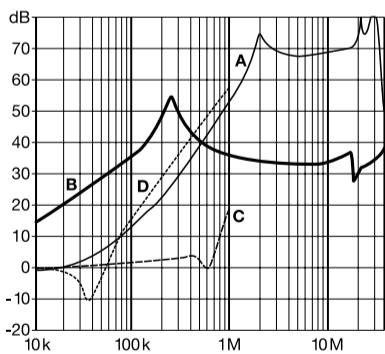

2 to 6 A types

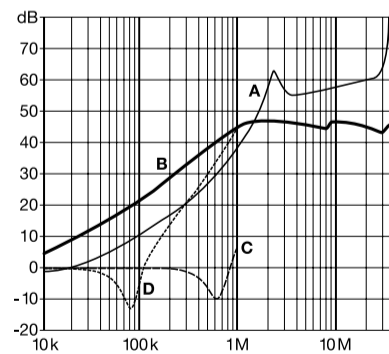

10 A types

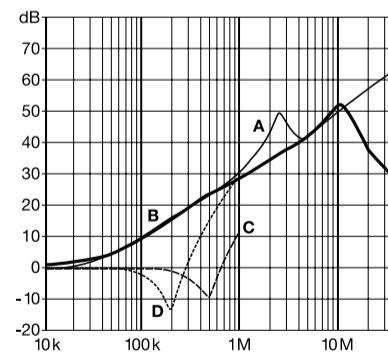

Mechanical Data

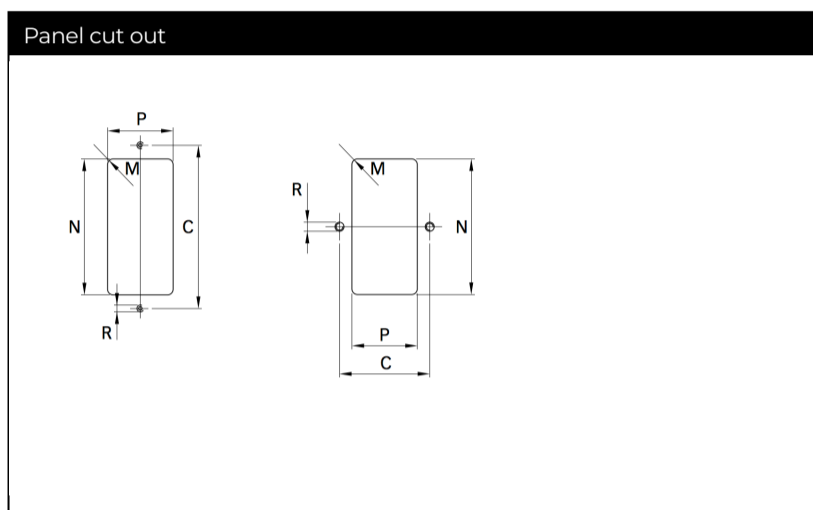
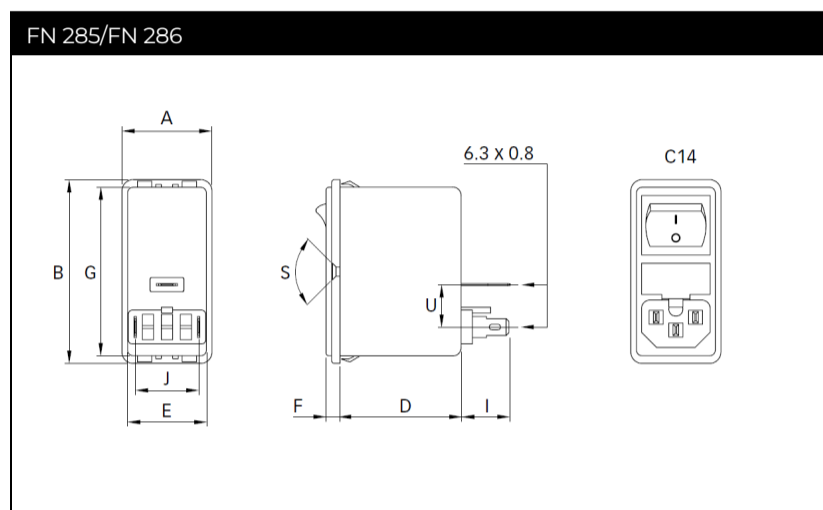
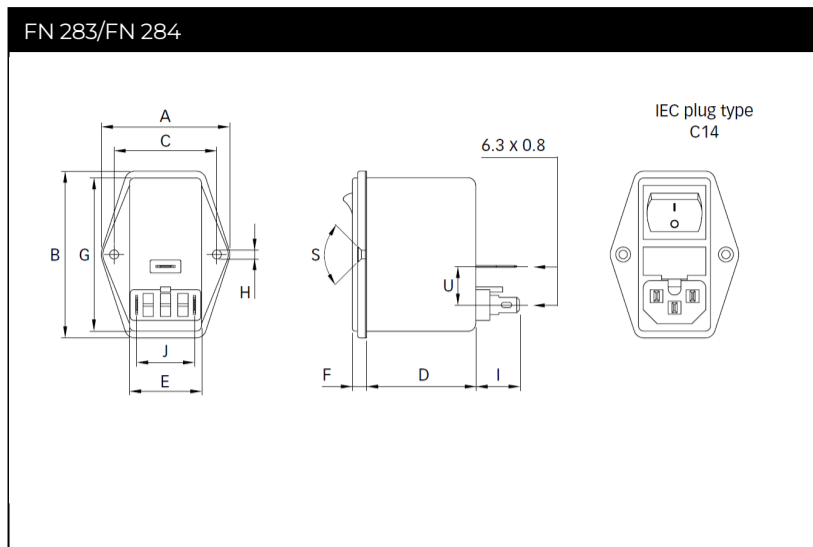
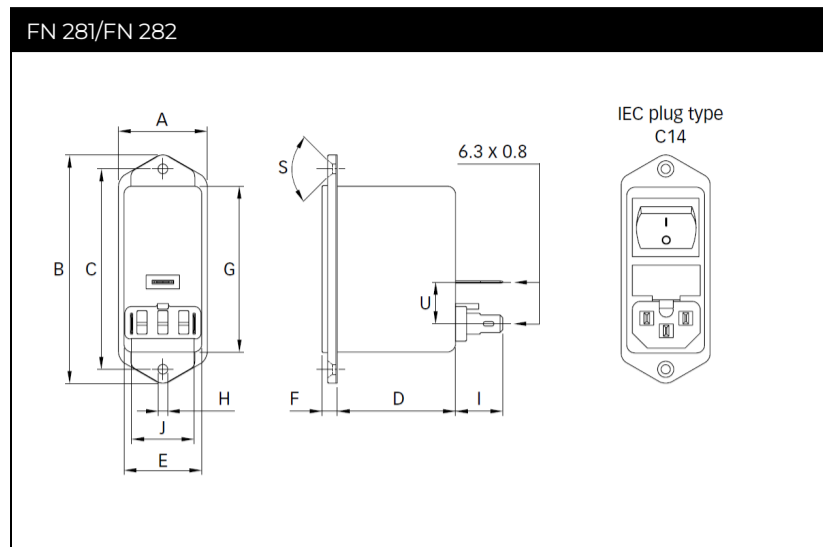

Dimensions

	FN 281	FN 282	FN 283	FN 284	FN 285	FN 286	Tolerances
A	32	32	50	50	32	32	±0.3
B	82	82	65	65	65	65	±0.3
C	72	72	40	40			±0.1
D	43.1	43.1	43.1	43.1	43.6	43.6	±0.3
E	28.5	28.5	28.5	28.5	28.5	28.5	±0.25
F	5.5	5.5	5.5	5.5	5	5	±0.3
G	59.95 max.	59.95 max.	59.95 max.	59.95 max.	59.95 max.	59.95 max.	
H	Ø3.5	Ø3.5	Ø3.3	Ø3.3			
I	13.4	16.2	13.4	16.2	13.9	16.7	±0.3
J	22.5	22.5	22.5	22.5	22.5	22.5	
M	R ≤2.5	R ≤2.5	R ≤2.5	R ≤2.5	R ≤2.5	R ≤2.5	
N	60	60	60	60	61.5+0.2/-0*	61.5+0.2/-0*	+0.5/-0
P	29	29	29	29	29	29	+0.5/-0
R	M3	M3	M3	M3			
S	90°	90°	90°	90°			

* For a panel thickness between 0.8 and 3 mm

All dimensions in mm; 1 inch = 25.4 mm

Tolerances according: ISO 2768-m/EN 22768-m

Please visit www.schaffner.com to find more details on filter connectors.

Headquarters, Global Innovation and Development

Switzerland

Schaffner Group
Industrie Nord
Nordstrasse 11e
4542
Luterbach
+41 32 681 66 26
info@schaffner.com

Sales and Application Centers

Finland

Schaffner Oy
Lohjanharjuntie 1109
8500
Lohja
+358 50 468 7284
finlandsales@schaffner.com

France

Schaffner EMC S.A.S.
16-20 Rue Louis Rameau
95875
Bezons
+33 1 34 34 30 60
francesales@schaffner.com

Germany

Schaffner Deutschland GmbH
Schoemperlenstrasse 12B
76185
Karlsruhe
+49 721 56910
germanysales@schaffner.com

India

Schaffner India Pvt. Ltd (Registered & Sales office)
Regus World Trade Centre
WTC 22nd Floor Unit No 2238 Brigade
Gateway Campus 26/1 Dr. Rajkumar Road
Malleshwaram (W)
560055
Bangalore
+91 8067935355
indiasales@schaffner.com

United Kingdom

Schaffner Ltd.
Suite 1 Oakmede Place
Terrace Road
RG42 4JF
Binfield
+44 118 9770070
uksales@schaffner.com

United States

Schaffner EMC Inc.
52 Mayfield Avenue
Edison, New Jersey
+1 732 225 9533
usasales@schaffner.com

Sweden

Schaffner EMC AB
Östermalmstrorg 1
114 42
Stockholm
+46 8 5050 2425
swedensales@schaffner.com

Switzerland

Schaffner EMV AG
Industrie Nord
Nordstrasse 11e
4542
Luterbach
+41 32 681 66 26
switzerlandsales@schaffner.com

Taiwan

Schaffner EMV Ltd.
U-Town
20 Floor-2 No 97 Section 1 XinTai 5th Road
XiZhi District
22175
New Taipei City
+886 226975500
taiwansales@schaffner.com

Italy

Schaffner EMC S.r.l.
Via Ticino, 30
20900
Monza (MB)
+39 039 21 41 070
italysales@schaffner.com

Japan

Schaffner EMC K.K.
ISM Sangenjaya
7F 1-32-12 Kamiuma Setagaya-ku
154-0011
Tokyo
+81 3 5712 3650
japansales@schaffner.com

Singapore

Schaffner EMC Pte Ltd.
Blk 3015A Ubi Road 1 #05-09 Kampong Ubi
Industrial Estate
408705
Singapore
+65 63773283
singaporesales@schaffner.com

To find your local partner within Schaffner's global network schaffner.com

© 2023 Schaffner Group

The content of this document has been carefully checked and understood. However, neither Schaffner nor its subsidiaries assume any liability whatsoever for any errors or inaccuracies of this document and the consequences thereof. Published specifications are subject to change without notice. Product suitability for any area of application must ultimately be determined by the customer. In all cases, products must never be operated outside their published specifications. Schaffner does not guarantee the availability of all published products. This disclaimer shall be governed by substantive Swiss law and resulting disputes shall be settled by the courts at the place of business of Schaffner Holding AG. Latest publications and a complete disclaimer can be downloaded from the Schaffner website. All trademarks recognized.

Looking for pricing, stock, or lifecycle information?

Click below to explore more details on WIN SOURCE:

- [View FN283-4-06 on WIN SOURCE](#)
- [Schaffner EMC Inc. Information](#)

Optimize Your Supply Chain with WIN SOURCE Solutions

- ✓ Global Sourcing Solution
- ✓ Obsolete Management
- ✓ Cost Control Management
- ✓ Shortage Management
- ✓ Alternative Solution
- ✓ Excess Inventory Management