



**THE DATASHEET OF
DEA252450BT-7022B1**



Multilayer Band Pass Filters(Balance Output Type), DEA Series

DEA212450BT-7042A1 for Bluetooth & 2.4GHz W-LAN

SHAPES AND DIMENSIONS

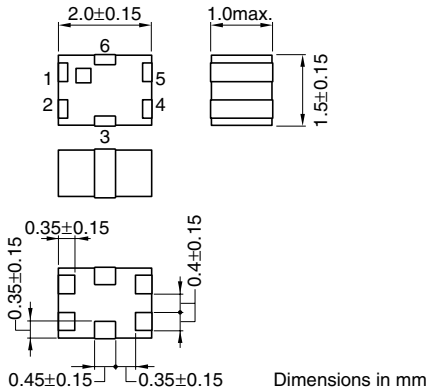

TERMINAL FUNCTIONS

1	Unbalanced port
2	Balanced port DC feed
3	GND
4	Balanced port
5	Balanced port
6	GND

RECOMMENDED PC BOARD PATTERN

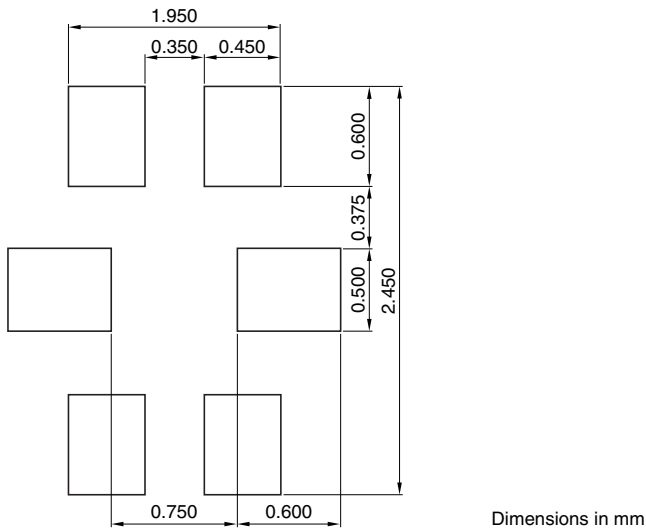

ELECTRICAL CHARACTERISTICS

Frequency range	2400 to 2500MHz	
RF input power	[2400 to 2500MHz]	8dBm max.
Insertion loss	[-30 to +85°C]	3.1dB max.
Single ended port characteristic impedance	50Ω(Nominal)	
Balanced port differential characteristics Impedance	50Ω(Nominal)	
Single ended Return Loss	[2400 to 2500MHz]	9.5dB min.
Balanced Return Loss	[2400 to 2500MHz]	9.5dB min.
Ripple	[2400 to 2500MHz]	1dB max.
Attenuation	[500 to 960MHz]	40dB min.
	[1570 to 1580MHz]	26dB min.
	[1710 to 1850MHz]	33dB min.
	[1850 to 1910MHz]	39dB min.
	[1920 to 1990MHz]	39dB min.
Phase difference at balanced port	[2110 to 2170MHz]	12dB min.
	[4800 to 5000MHz]	20dB min.
Phase difference at balanced port	180±15deg	
Amplitude impedance at balanced port	0±2.0dB	
Temperature range	Operating	-30 to +85°C
	Storage	-30 to +85°C

EVALUATION BOARD

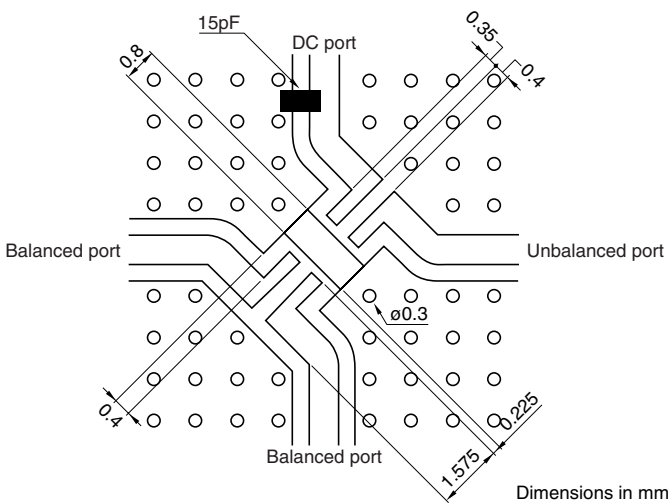

• All specifications are subject to change without notice.

FREQUENCY CHARACTERISTICS

Unbalance 50Ω/Balance 200Ω

INPUT RETURN LOSS

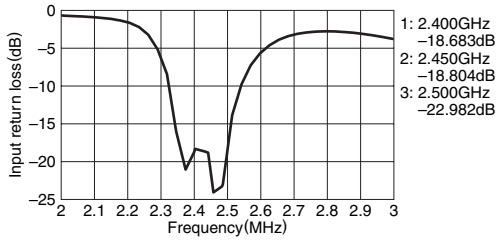

AMPLITUDE BALANCE

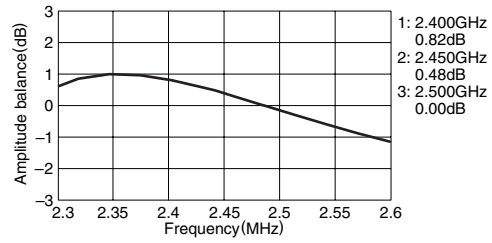

ATTENUATION

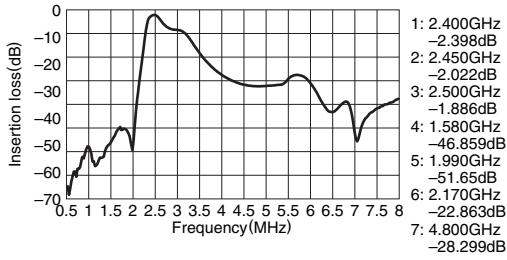

PHASE BALANCE

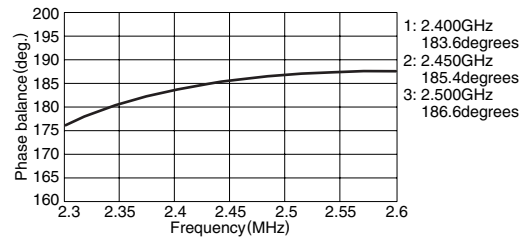

INSERTION LOSS

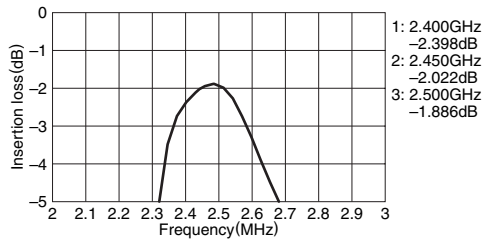

OUTPUT RETURN LOSS

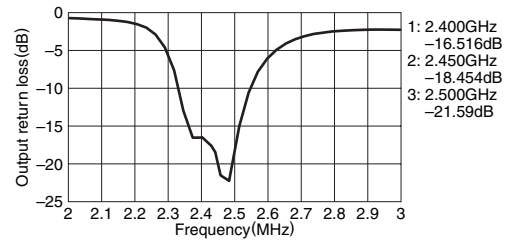

Multilayer Band Pass Filters(Balance Output Type), DEA Series

DEA252450BT-7001B1 for Bluetooth & 2.4GHz W-LAN

SHAPES AND DIMENSIONS

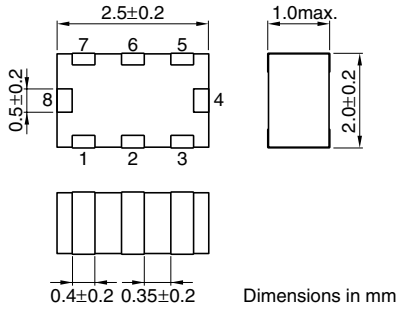

TERMINAL FUNCTIONS

1	Balanced
2	Balanced
3	GND
4	Unbalanced
5	GND
6	GND or DC feed
7	GND
8	GND

RECOMMENDED PC BOARD PATTERN

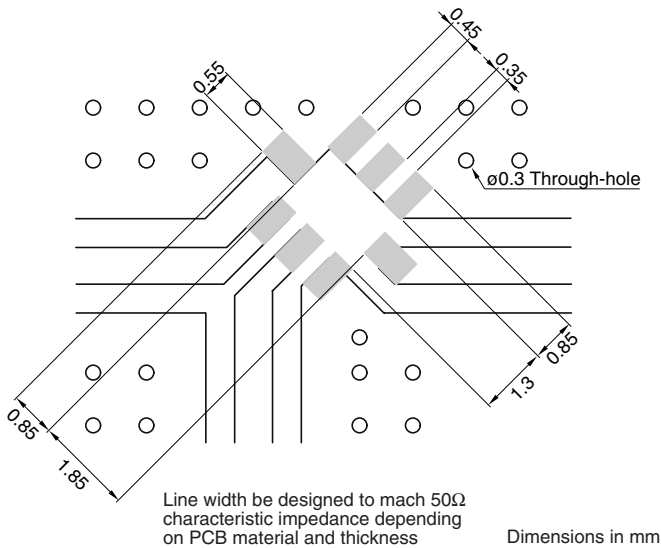

ELECTRICAL CHARACTERISTICS

Unbalanced impedance	50Ω(Nominal)	
Balanced impedance	50Ω(Nominal)	
Frequency range	2400 to 2500MHz	
Insertion loss	[+25°C]	2.4dB max.
	[-40 to +85°C]	2.7dB max.
Attenuation	[1710 to 1920MHz]	25dB min.
	[4800 to 5000MHz]	15dB min.
Unbalanced port return loss	10dB min.	
Phase difference at balanced port	180±20deg	
Amplitude impedance at balanced port	0±2.0dB	
Temperature range	Operating	-40 to +85°C
	Storage	-40 to +85°C

FREQUENCY CHARACTERISTICS

Unbalance 50Ω/Balance 200Ω

ATTENUATION vs. INSERTION LOSS

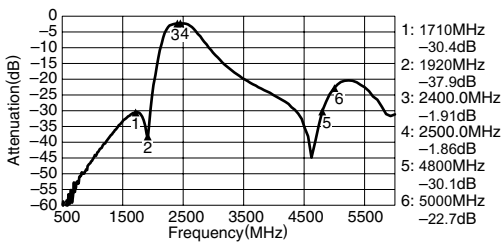

AMPLITUDE BALANCE

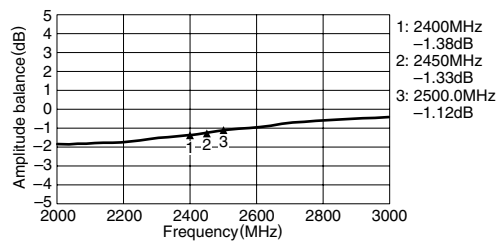

UNBALANCED PORT RETURN LOSS

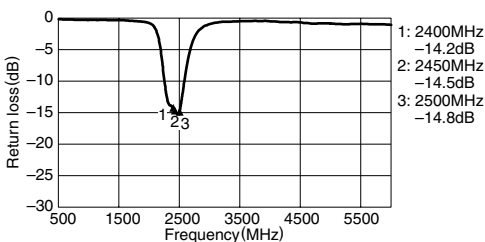

PHASE BALANCE

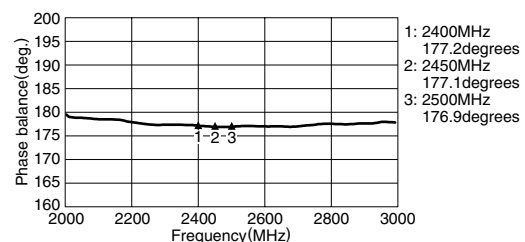

• All specifications are subject to change without notice.

Multilayer Band Pass Filters(Balance Output Type), DEA Series

DEA252450BT-7004B1 for Bluetooth & 2.4GHz W-LAN

SHAPES AND DIMENSIONS

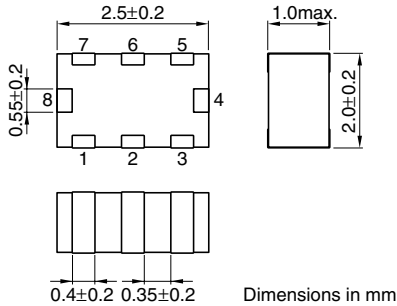

TERMINAL FUNCTIONS

1	Balanced
2	Balanced
3	GND
4	Unbalanced
5	GND
6	GND or DC feed
7	GND
8	GND

ELECTRICAL CHARACTERISTICS

Unbalanced impedance	50Ω nom.	
Balanced impedance	200Ω nom.	
Frequency range	2400 to 2500MHz	
Insertion loss	[+25°C]	3.0dB max.
	[-40 to +85°C]	3.3dB max.
Attenuation	[1710 to 1920MHz]	25dB min.
	[4800 to 5000MHz]	15dB min.
Unbalanced port return loss	5dB min.	
Phase difference at balanced port	180±10deg	
Amplitude impedance at balanced port	0±2.0dB	
Temperature range	Operating	-40 to +85°C
	Storage	-40 to +85°C

FREQUENCY CHARACTERISTICS

Unbalance 50Ω/Balance 200Ω

ATTENUATION vs. INSERTION LOSS

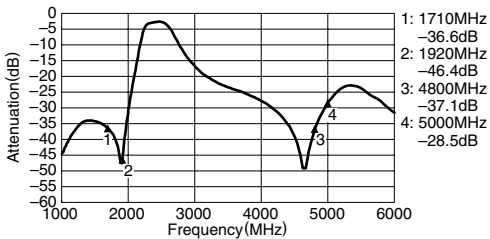

AMPLITUDE BALANCE

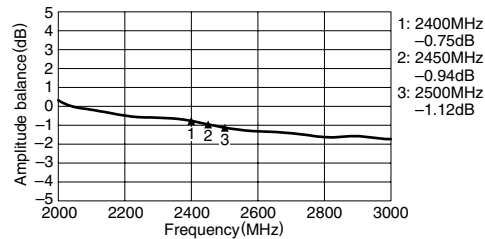

RETURN LOSS

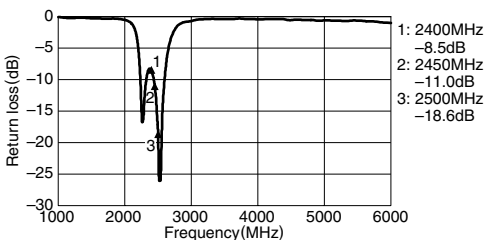

INSERTION LOSS

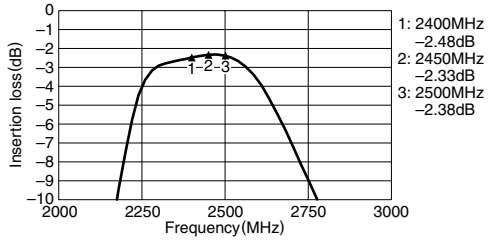

PHASE BALANCE

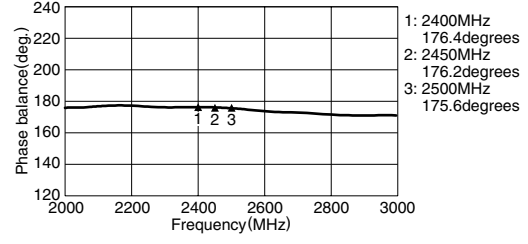

Multilayer Band Pass Filters(Balance Output Type), DEA Series

DEA252450BT-7012D1 for Bluetooth & 2.4GHz W-LAN

SHAPES AND DIMENSIONS

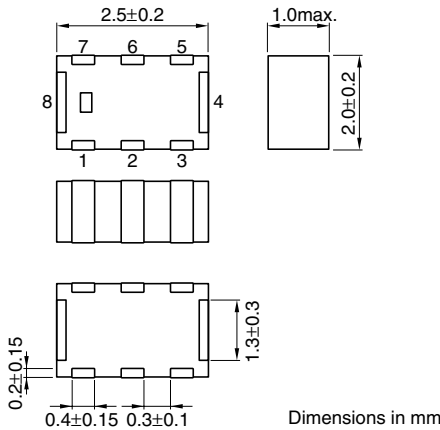

TERMINAL FUNCTIONS

1	N.C.
2	Unbalanced
3	DC feed or GND
4	GND
5	Balanced
6	N.C.
7	Balanced
8	GND

RECOMMENDED PC BOARD PATTERN

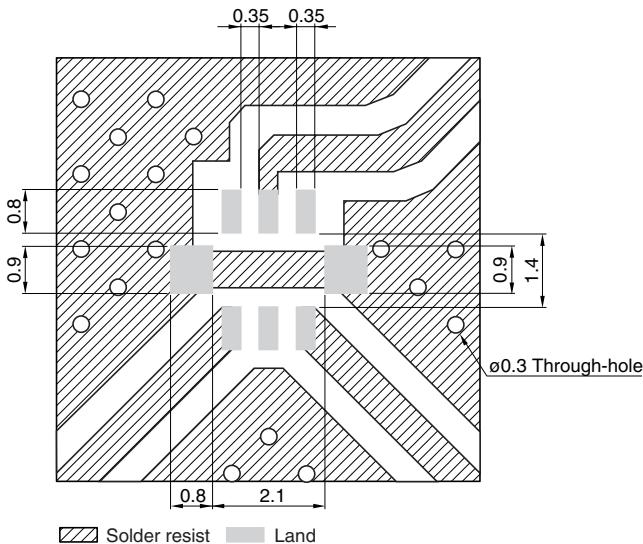

Line width be designed to mach 50Ω characteristic impedance depending on PCB material and thickness

Dimensions in mm

ELECTRICAL CHARACTERISTICS

Item	Typical value	
Unbalanced impedance	50Ω(Nominal)	—
Balanced impedance	100Ω(Nominal)	—
Frequency range (Pass Band)	2400 to 2500MHz	—
Insertion loss	[+25°C]	1.9dB max.
	[-40 to +85°C]	2.2dB max.
Attenuation	[880 to 960MHz]	40dB min.
	[1710 to 1910MHz]	32dB min.
	[4800 to 5000MHz]	30dB min.
Unbalanced port return loss	10dB min.	14dB
Phase difference at balanced port	180±12deg	188deg
Amplitude impedance at balanced port	0±1.0dB	0dB
Temperature range	Operating	-40 to +85°C
	Storage	-40 to +85°C

• All specifications are subject to change without notice.

FREQUENCY CHARACTERISTICS

Unbalance 50Ω/Balance 100Ω

ATTENUATION

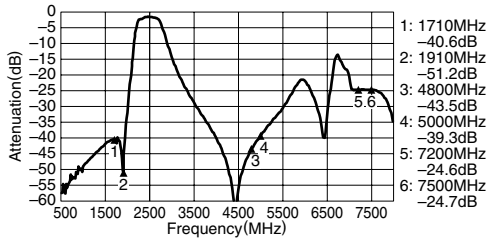

AMPLITUDE BALANCE

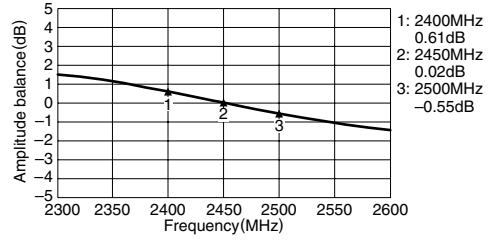

UNBALANCED PORT RETURN LOSS

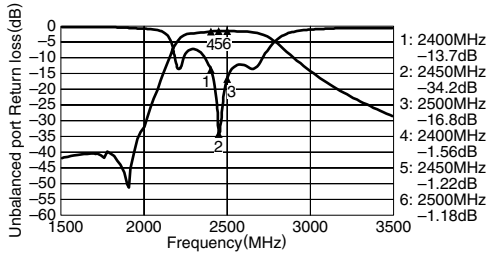

PHASE BALANCE

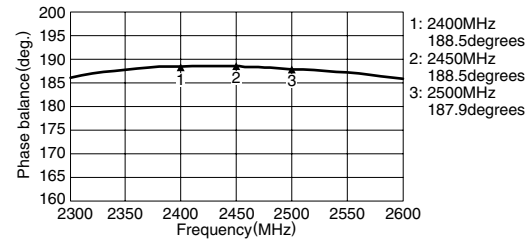

• All specifications are subject to change without notice.

Multilayer Band Pass Filters(Balance Output Type), DEA Series

DEA252450BT-7014D1 for Bluetooth & 2.4GHz W-LAN

SHAPES AND DIMENSIONS

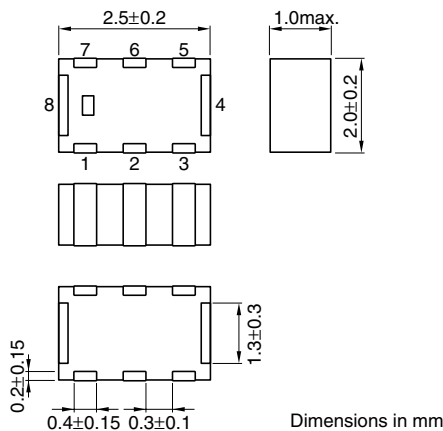

TERMINAL FUNCTIONS

1	N.C.
2	Unbalanced
3	DC feed or GND
4	GND
5	Balanced
6	N.C.
7	Balanced
8	GND

RECOMMENDED PC BOARD PATTERN

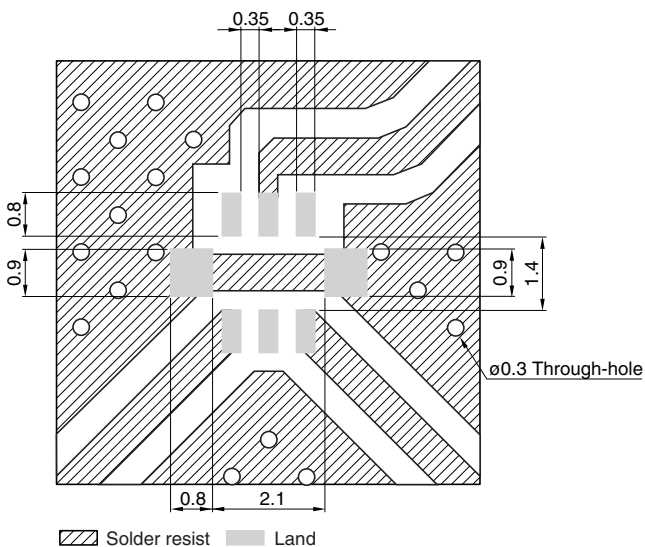

Line width be designed to mach 50Ω characteristic impedance depending on PCB material and thickness

Dimensions in mm

ELECTRICAL CHARACTERISTICS

Item	Typical value	
Unbalanced impedance	50Ω(Nominal)	—
Balanced impedance	50Ω(Nominal)	—
Frequency range (Pass Band)	2400 to 2500MHz	—
Insertion loss	[+25°C]	1.7dB max.
	[-40 to +85°C]	2.0dB max.
Attenuation	[880 to 960MHz]	40dB min.
	[1710 to 1910MHz]	32dB min.
	[4800 to 5000MHz]	30dB min.
Unbalanced port return loss	10dB min.	17dB
Phase difference at balanced port	180±15deg	190deg
Amplitude impedance at balanced port	0±1.0dB	0.2dB
Temperature range	Operating	-40 to +85°C
	Storage	-40 to +85°C

• All specifications are subject to change without notice.

FREQUENCY CHARACTERISTICS

Unbalance 50Ω/Balance 50Ω

ATTENUATION vs. INSERTION LOSS

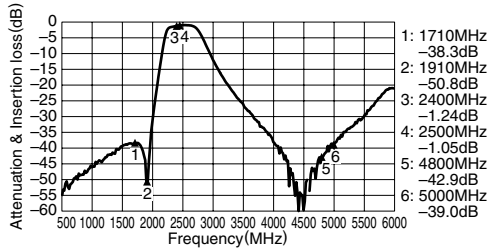

AMPLITUDE BALANCE

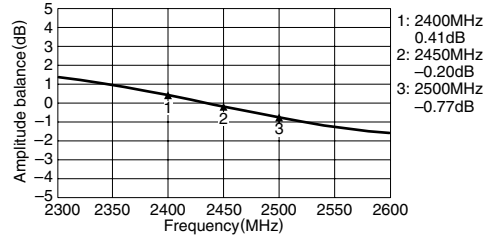

UNBALANCED PORT RETURN LOSS

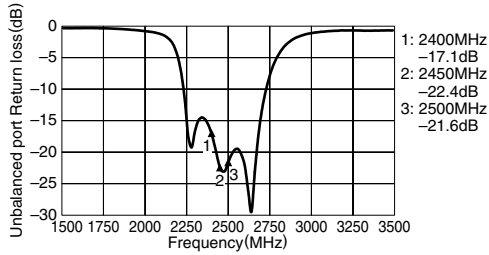

PHASE BALANCE

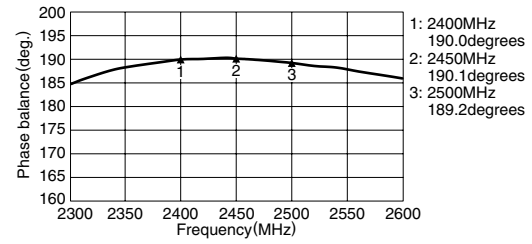

• All specifications are subject to change without notice.

Multilayer Band Pass Filters(Balance Output Type), DEA Series

DEA252450BT-7022B1 for Bluetooth & 2.4GHz W-LAN

SHAPES AND DIMENSIONS

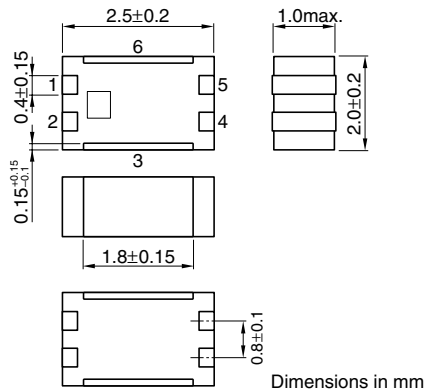

TERMINAL FUNCTIONS

1	Unbalanced
2	DC feed or RF GND
3	GND
4	Balanced
5	Balanced
6	GND

RECOMMENDED PC BOARD PATTERN

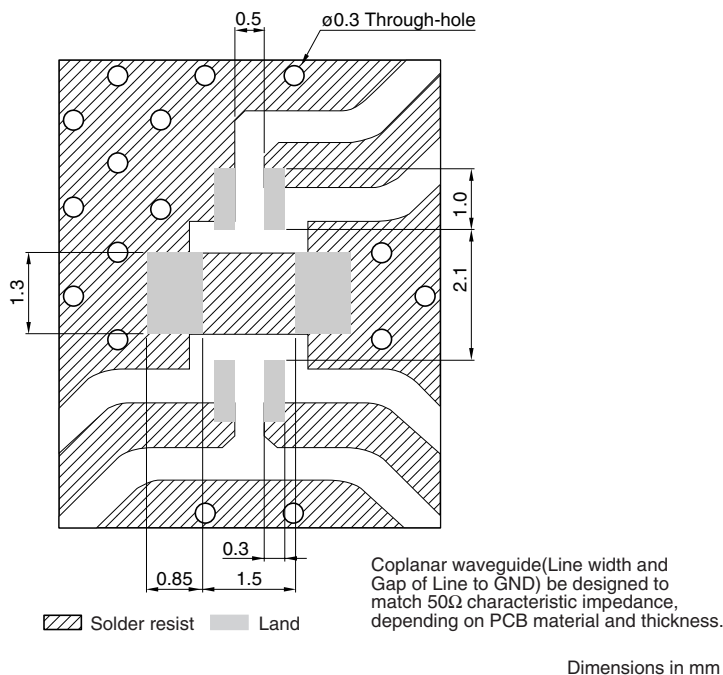

ELECTRICAL CHARACTERISTICS

Item	Typical value	
Frequency range (Pass Band)	2400 to 2500MHz	—
Unbalanced impedance	50Ω(Nominal)	—
Balanced impedance	100Ω(Nominal)	—
Unbalanced port return loss	9.5dB min.	—
Insertion loss (Pass Band)	[+25°C]	3.0dB max.
	[-40 to +85°C]	3.3dB max.
Ripple (Pass Band)	1.0dB max.	0.2dB
Attenuation	[880 to 960MHz]	48dB min.
	[1710 to 1880MHz]	45dB min.
	[1880 to 1980MHz]	40dB min.
	[2110 to 2170MHz]	25dB min.
	[4800 to 5000MHz]	30dB min.
Amplitude impedance at balanced port	1.0dB max.	-0.2dB
Phase difference at balanced port	[25°C]	180±8deg
	[-40 to +85°C]	180±10deg
Temperature range	Operating	-40 to +85°C
	Storage	-40 to +85°C

• All specifications are subject to change without notice.

FREQUENCY CHARACTERISTICS

Unbalance 50Ω/Balance 100Ω

ATTENUATION vs. INSERTION LOSS

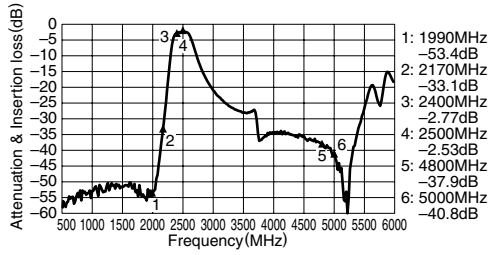

AMPLITUDE BALANCE

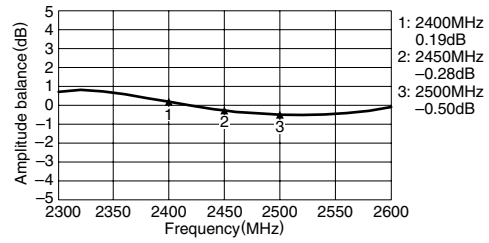

UNBALANCED PORT RETURN LOSS

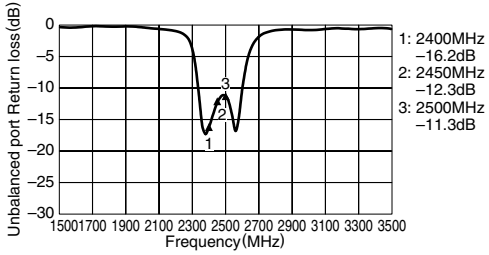

PHASE BALANCE

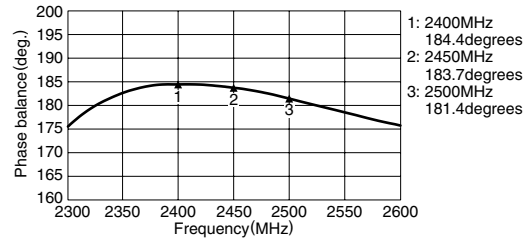

• All specifications are subject to change without notice.

Multilayer Band Pass Filters(Balance Output Type), DEA Series

DEA252450BT-7030B1 for Bluetooth & 2.4GHz W-LAN

SHAPES AND DIMENSIONS

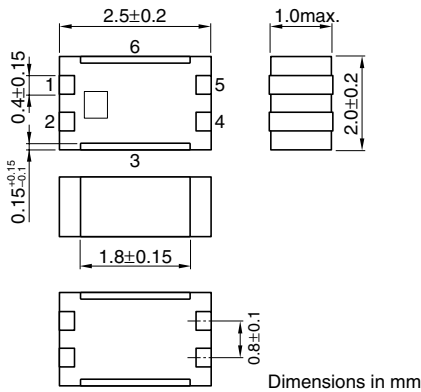

TERMINAL FUNCTIONS

1	Unbalanced
2	DC feed or RF GND
3	GND
4	Balanced
5	Balanced
6	GND

RECOMMENDED PC BOARD PATTERN

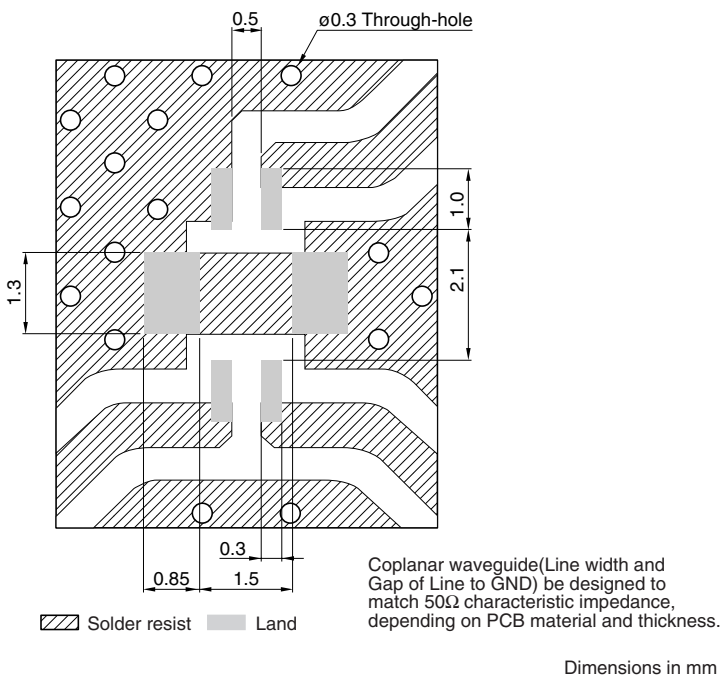

ELECTRICAL CHARACTERISTICS

Item	Typical value	
Frequency range (Pass Band)	2400 to 2500MHz	
Unbalanced impedance	50Ω(Nominal)	
Balanced impedance	18+j28Ω(Nominal)	
Unbalanced port return loss	6.0dB min. 10dB	
Insertion loss (Pass Band)	[+25°C]	3.3dB max. 3.1dB
	[-40 to +85°C]	3.6dB max. 3.4dB
Ripple (Pass Band)		1.0dB max. 0.3dB
	[880 to 960MHz]	48dB min. 57dB
	[1710 to 1990MHz]	40dB min. 43dB
	[3900 to 4100MHz]	30dB min. 37dB
Attenuation	[4800 to 5000MHz]	30dB min. 50dB
Amplitude impedance at balanced port	1.8dB max. 1.4dB	
Phase difference at balanced port	[25°C]	180±7deg 183deg
	[-40 to +85°C]	180±10deg —
Temperature range	Operating	-40 to +85°C
	Storage	-40 to +85°C

• All specifications are subject to change without notice.

FREQUENCY CHARACTERISTICS

Unbalance 50Ω/Balance 18+j28Ω

ATTENUATION & INSERTION LOSS

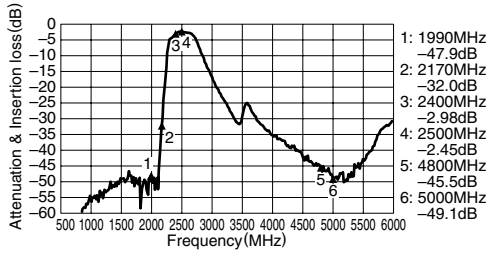

AMPLITUDE BALANCE

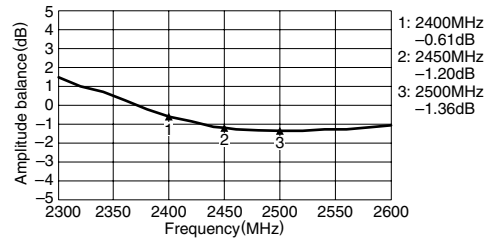

UNBALANCED PORT RETURN LOSS

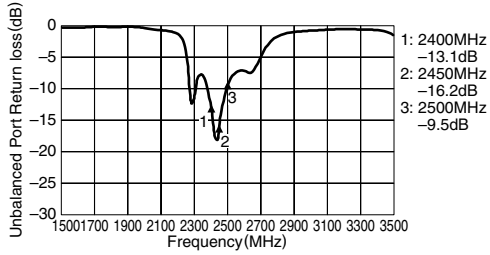

PHASE BALANCE

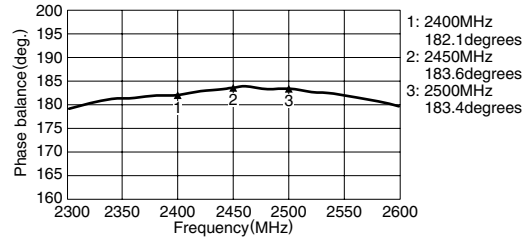

• All specifications are subject to change without notice.

FREQUENCY CHARACTERISTICS

Unbalance 50Ω/Balance 200Ω

ATTENUATION

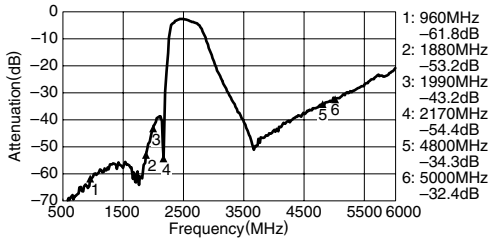

INSERTION LOSS

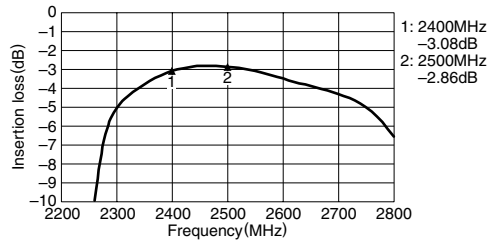

UNBALANCED PORT RETURN LOSS

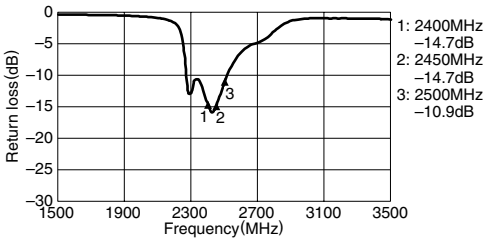

BALANCED PORT RETURN LOSS

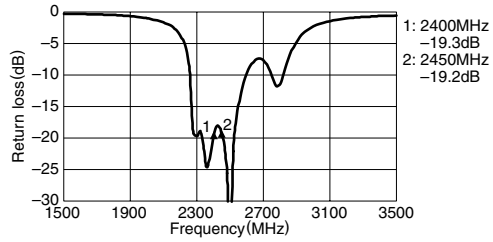

AMPLITUDE BALANCE

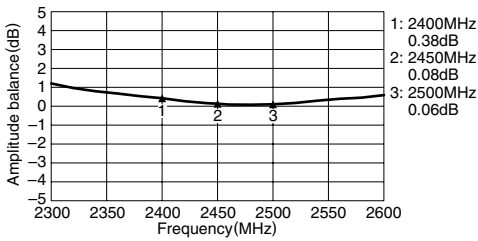

PHASE BALANCE

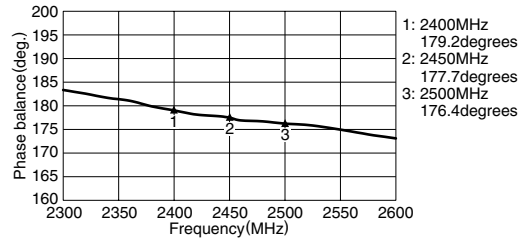

• All specifications are subject to change without notice.

Multilayer Band Pass Filters(Balance Output Type), DEA Series

DEA255512BT-7006A2 for 5GHz W-LAN

SHAPES AND DIMENSIONS/CIRCUIT

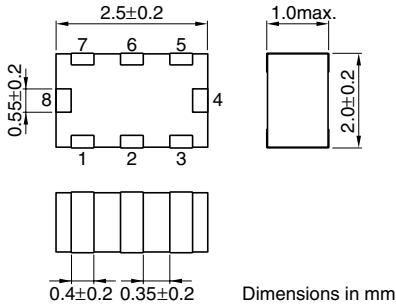

TERMINAL FUNCTIONS

1	Balanced
2	Balanced
3	GND
4	Unbalanced
5	GND
6	GND or DC feed
7	NC
8	GND

RECOMMENDED PC BOARD PATTERN

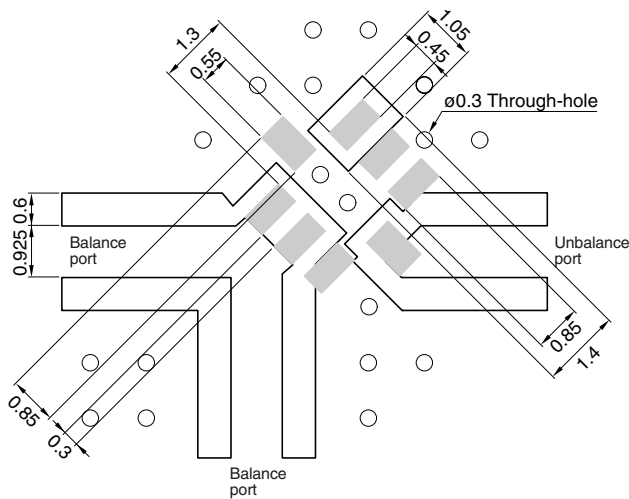

Line width be designed to mach 50Ω characteristic impedance depending on PCB material and thickness

Dimensions in mm

ELECTRICAL CHARACTERISTICS

Unbalanced impedance	50Ω
Balanced impedance	100Ω
Frequency range	5150 to 5875MHz
Input Return Loss	8dB min.
Insertion loss	[25°C] 2.5dB max. [FULL TEMP] 2.8dB max.
Attenuation	[DC-2700MHz] 35dB min. [10300 to 10700MHz] 20dB min.
Phase difference at balanced port	180±10deg
Amplitude impedance at balanced port	0±1.5dB max.
Temperature range	Operating -40 to +85°C Storage -40 to +85°C

FREQUENCY CHARACTERISTICS

Unbalance 50Ω/Balance 200Ω

INPUT RETURN LOSS

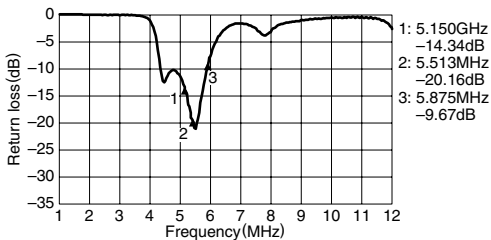

AMPLITUDE BALANCE

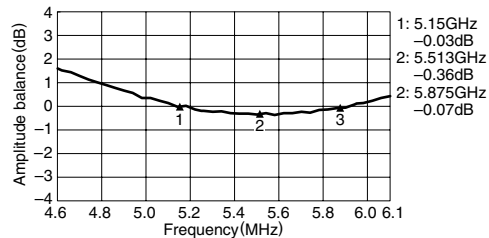

ATTENUATION

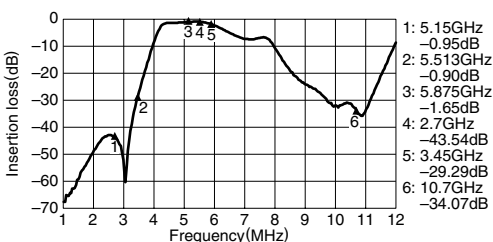

PHASE BALANCE

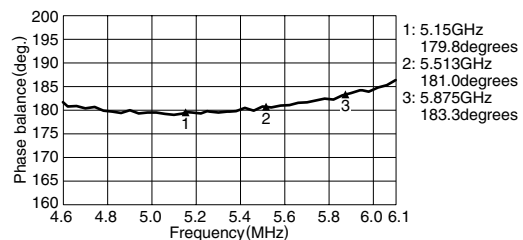

• All specifications are subject to change without notice.

Multilayer Band Pass Filters(Balance Output Type), DEA Series

DEA255250BT-7007A2 for 5GHz W-LAN

SHAPES AND DIMENSIONS

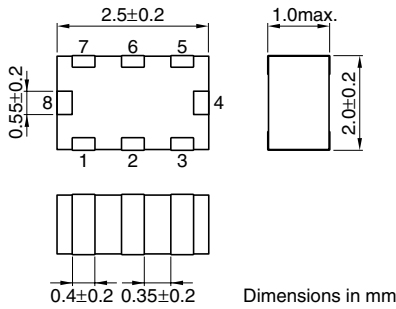

TERMINAL FUNCTIONS

1	Balanced
2	Balanced
3	GND
4	Unbalanced
5	GND
6	GND or DC feed
7	NC
8	GND

RECOMMENDED PC BOARD PATTERN

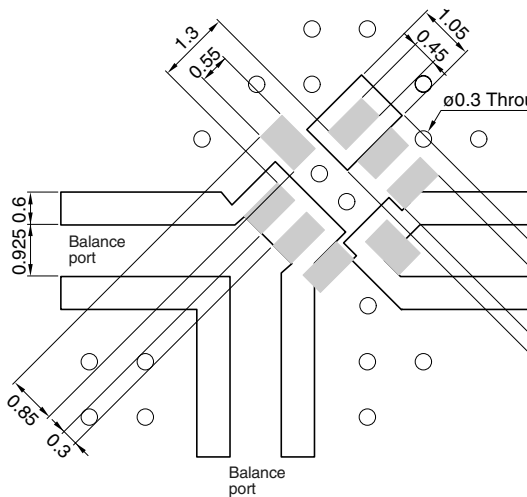

Line width be designed to match 50Ω characteristic impedance depending on PCB material and thickness

Dimensions in mm

ELECTRICAL CHARACTERISTICS

Unbalanced impedance	50Ω
Balanced impedance	100Ω
Frequency range	5150 to 5350 MHz
Input Return Loss	9 dB min.
Insertion loss	[25°C] 2.0dB max. [FULL TEMP] 2.3dB max.
Attenuation	[DC-2700MHz] 35dB min. [10300 to 10700MHz] 20dB min.
Phase difference at balanced port	180±10deg
Amplitude impedance at balanced port	0±1.0dB
Temperature range	Operating -40 to +85°C Storage -40 to +85°C

FREQUENCY CHARACTERISTICS

Unbalance 50Ω/Balanced 200Ω

INPUT RETURN LOSS

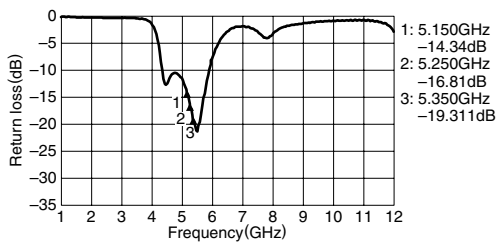

AMPLITUDE BALANCE

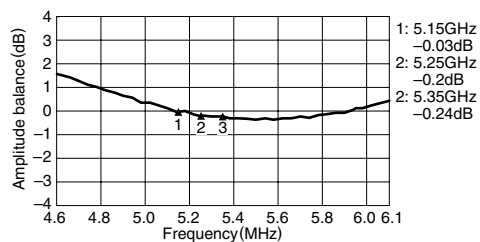

ATTENUATION

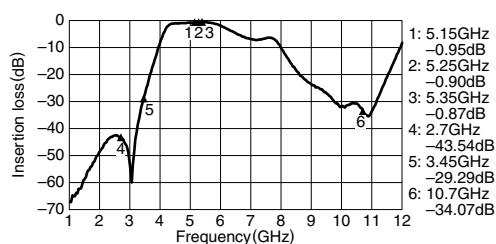

PHASE BALANCE

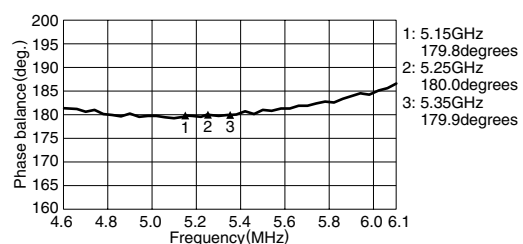

• All specifications are subject to change without notice.

Multilayer Band Pass Filters(Balance Output Type), DEA Series

DEA255425BT-7008A2 5GHz W-LAN

SHAPES AND DIMENSIONS



TERMINAL FUNCTIONS

1	Balanced
2	Balanced
3	GND
4	Unbalanced
5	GND
6	GND or DC feed
7	NC
8	GND

RECOMMENDED PC BOARD PATTERN

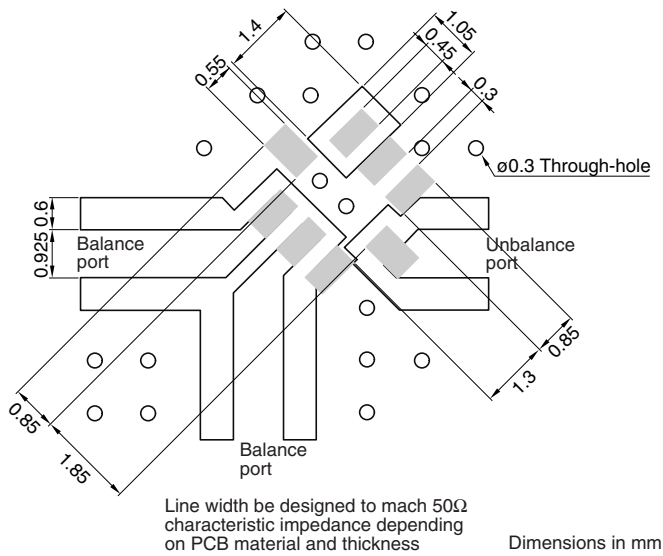

ELECTRICAL CHARACTERISTICS

Unbalanced impedance	50Ω(Nominal)	
Balanced impedance	100Ω(Nominal)	
Frequency range (Pass Band)	4900 to 5950MHz	
Insertion loss	[+25°C]	2.5dB max.
	[Full temp]	2.8dB max.
Attenuation	[DC to 2700MHz]	35dB min.
	[10300 to 10700MHz]	20dB min.
Input return loss	7dB min.	
Phase imbalance at balanced ports	180±15deg	
Amplitude impedance at balanced port	0±2.0dB	
Temperature range	Operating	-40 to +85°C
	Storage	-40 to +85°C

FREQUENCY CHARACTERISTICS

Unbalance 50Ω/Balance 100Ω

INPUT RETURN LOSS

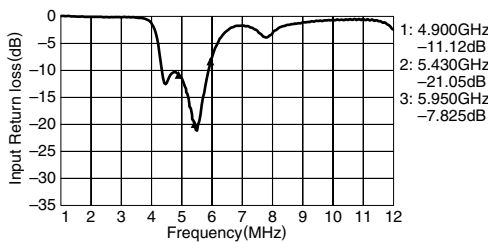

AMPLITUDE BALANCE

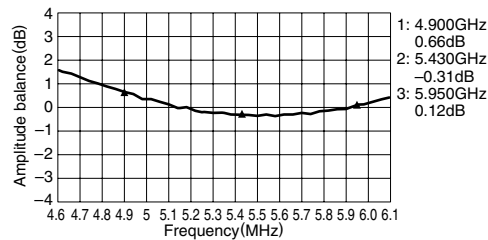

ATTENUATION

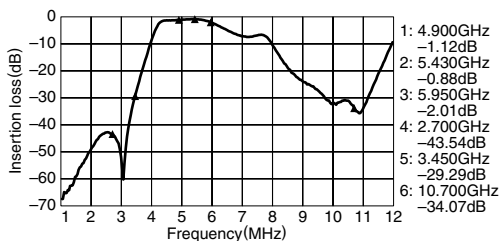

PHASE BALANCE

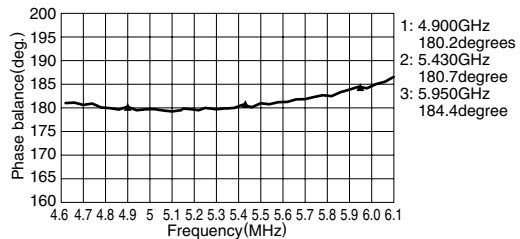

• All specifications are subject to change without notice.

Looking for pricing, stock, or lifecycle information?

Click below to explore more details on WIN SOURCE:

- ⊖ [View DEA252450BT-7022B1 on WIN SOURCE](#)
- ⊖ [TDK Corporation Information](#)

Optimize Your Supply Chain with WIN SOURCE Solutions

- ✓ Global Sourcing Solution
- ✓ Obsolete Management
- ✓ Cost Control Management
- ✓ Shortage Management
- ✓ Alternative Solution
- ✓ Excess Inventory Management