



**THE DATASHEET OF
DEA252450BT-2027A1**





Multilayer Band Pass Filter

For 2400-2500MHz

DEA252450BT-2027A1

2.5x2.0mm [EIA 1008]*

* Dimensions Code JIS[EIA]

Multilayer Band Pass Filter

Conformity to RoHS Directive

For 2400-2500MHz

DEA252450BT-2027A1

SHAPES AND DIMENSIONS

[Top view]

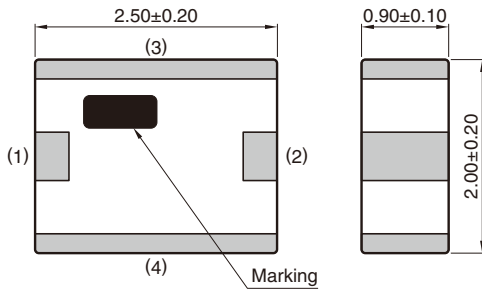

[Bottom view]

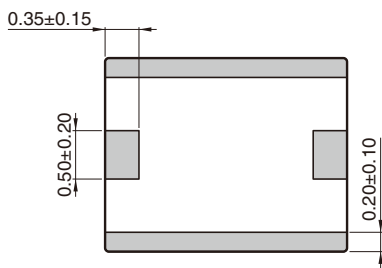

Terminal functions

1	IN
2	OUT
3	GND
4	GND

Dimensions in mm

RECOMMENDED LAND PATTERN

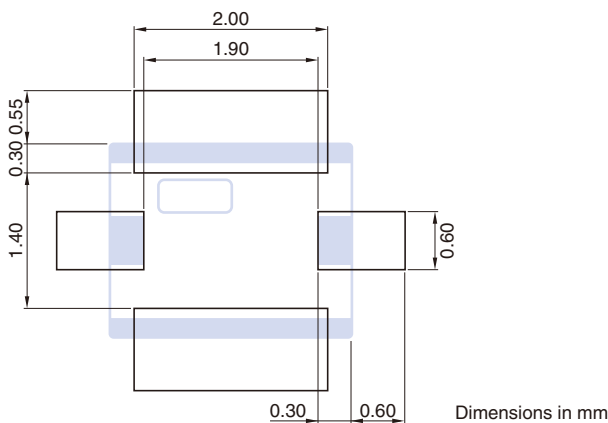

Dimensions in mm

EVALUATION BOARD

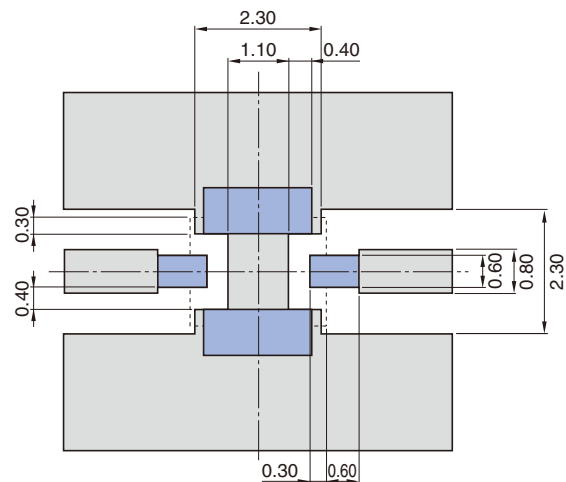

Line width be designed to match 50Ω characteristic impedance depending on PCB material and thickness.

Dimensions in mm

RoHS Directive Compliant Product: See the following for more details related to RoHS Directive compliant products. <http://product.tdk.com/en/environment/rohs/>

- All specifications are subject to change without notice.
- Before using these products, be sure to request the delivery specifications.

DEA252450BT-2027A1

ELECTRICAL CHARACTERISTICS

Item	Frequency Range (MHz)	Min.	Typ.	Max.
Insertion Loss (dB)	2400 to 2500	—	1.00	1.2
	2400 to 2500	—	—	1.5 (−40 to +85°C)
Return Loss (dB)	2400 to 2500	10	19.5	—
	880 to 915	35	48.6	—
Attenuation (dB)	1710 to 1790	35	42.7	—
	1850 to 1910	35	40.2	—
	4800 to 5000	30	42.7	—
	7200 to 7500	25	—	—
Power Handling (W)	2400 to 2500	—	—	0.5
Characteristic Impedance (Ω)			50 (Nominal)	

· Ta: +25±5°C

TEMPERATURE RANGE

Operating temperature (°C)	Storage temperature (°C)
−40 to +85	−40 to +85

- All specifications are subject to change without notice.
- Before using these products, be sure to request the delivery specifications.

DEA252450BT-2027A1

FREQUENCY CHARACTERISTICS

INSERTION LOSS

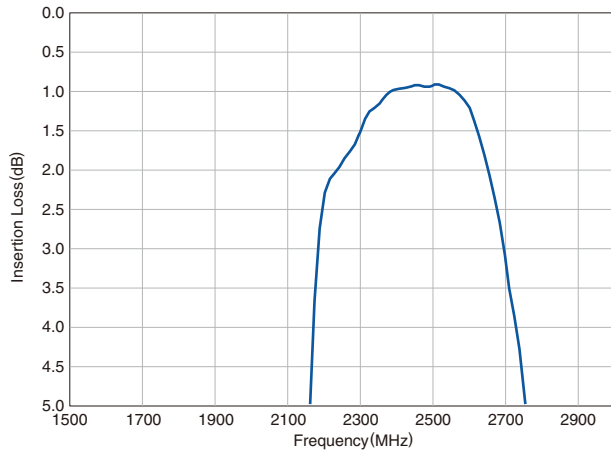

ATTENUATION

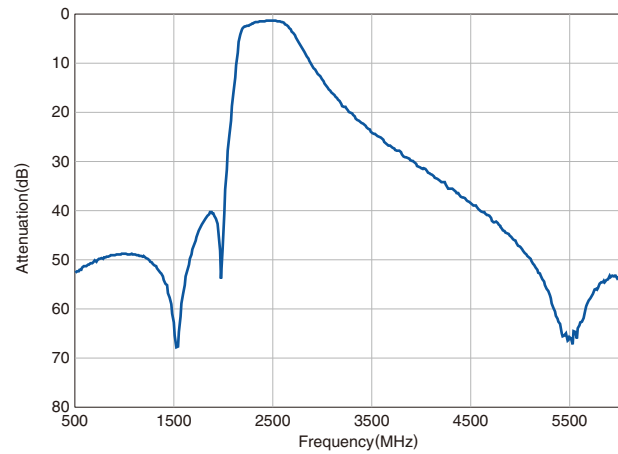

RETURN LOSS

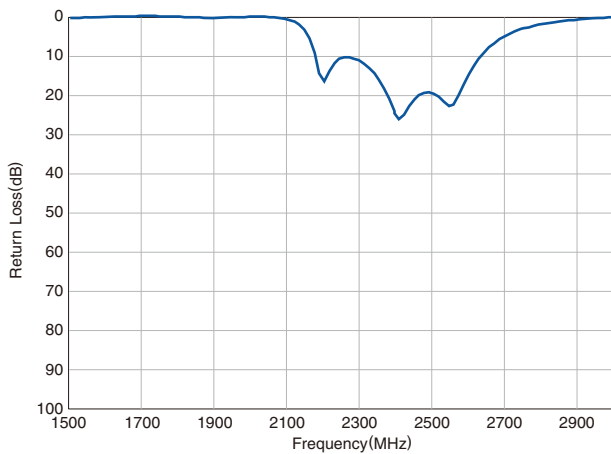

- All specifications are subject to change without notice.
- Before using these products, be sure to request the delivery specifications.

RECOMMENDED REFLOW PROFILE

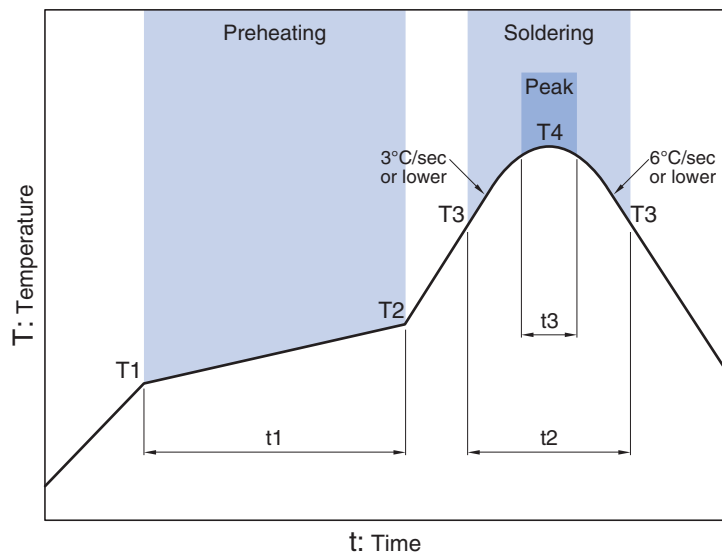

Preheating			Soldering			
Temp.	Temp.	Time	Critical zone (T3 to T4)		Temp.	Time
T1	T2	t1	T3	t2	T4	t3*
150°C	200°C	60 to 120sec	217°C	60 to 120sec	240 to 260°C	30sec max.

* t3 : Time within 5°C of actual peak temperature
 The maximum number of reflow is 3.

REMINDERS FOR USING THESE PRODUCTS

Before using these products, be sure to request the delivery specifications.

SAFETY REMINDERS

Please pay sufficient attention to the warnings for safe designing when using these products.

REMINDERS

The products listed on this catalog are intended for use in general electronic equipment (AV equipment, telecommunications equipment, home appliances, amusement equipment, computer equipment, personal equipment, office equipment, measurement equipment, industrial robots) under a normal operation and use condition.

The products are not designed or warranted to meet the requirements of the applications listed below, whose performance and/or quality require a more stringent level of safety or reliability, or whose failure, malfunction or trouble could cause serious damage to society, person or property.

Please understand that we are not responsible for any damage or liability caused by use of the products in any of the applications below or for any other use exceeding the range or conditions set forth in this catalog.

- | | |
|---|--|
| (1) Aerospace/Aviation equipment | (8) Public information-processing equipment |
| (2) Transportation equipment (cars, electric trains, ships, etc.) | (9) Military equipment |
| (3) Medical equipment | (10) Electric heating apparatus, burning equipment |
| (4) Power-generation control equipment | (11) Disaster prevention/crime prevention equipment |
| (5) Atomic energy-related equipment | (12) Safety equipment |
| (6) Seabed equipment | (13) Other applications that are not considered general-purpose applications |
| (7) Transportation control equipment | |

When using this product in general-purpose applications, you are kindly requested to take into consideration securing protection circuit/equipment or providing backup circuits, etc., to ensure higher safety.

Looking for pricing, stock, or lifecycle information?

Click below to explore more details on WIN SOURCE:

- ⊖ [View DEA252450BT-2027A1](#) on WIN SOURCE
- ⊖ [TDK Corporation](#) Information

Optimize Your Supply Chain with WIN SOURCE Solutions

- ✓ Global Sourcing Solution
- ✓ Obsolete Management
- ✓ Cost Control Management
- ✓ Shortage Management
- ✓ Alternative Solution
- ✓ Excess Inventory Management