

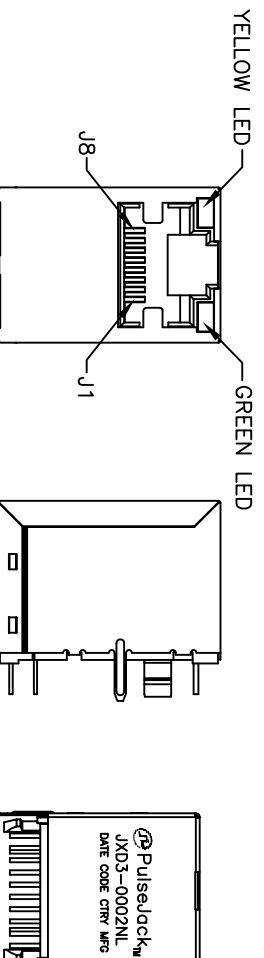

**THE DATASHEET OF  
JXD3-0002NL**





CRO-INCHS MIN  
 OMITTED SEE  
 AND REGULATION  
 SOLDERING IS  
 5°C.  
 C.  
 200 PCS/BOX.

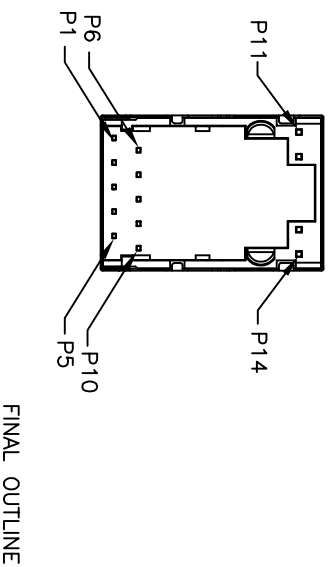

All rights reserved. Pulse confidential & proprietary. (05/15/15)

TLA DRAWING	PS DRAWING	SHEET	PART NO.	DATASHEET REV.
XD3-0002NL-X1	-	1 OF 5	JXD3-0002NL	A

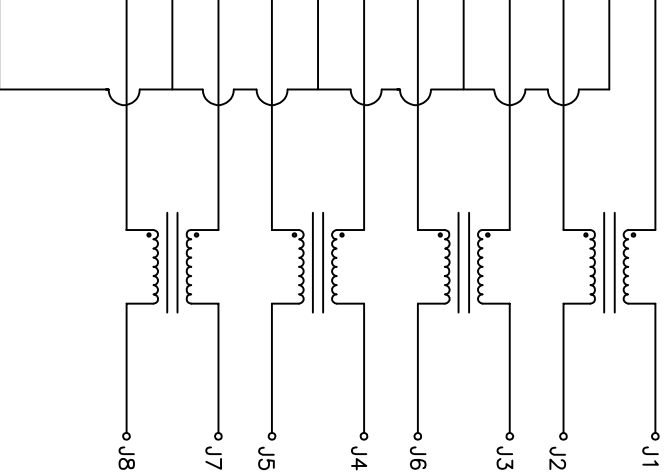

ELECTRONICAL SPECIFICATIONS:

- 1.0 TURN RATIO @100KHZ: (P5~P9):(J1~J2) = 1:1±5%  
(P4~P8):(J3~J6) = 1:1±5%  
(P3~P7):(J4~J5) = 1:1±5%  
(P2~P6):(J7~J8) = 1:1±5%
- 2.0 PRIMARY INDUCTANCE: 350uH MIN @100KHZ, 0.1V 8mA DC BIAS
- 3.0 DC RESISTANCE: 1.2 OHMS MAX
- 4.0 INSERTION LOSS: 1~100MHZ -1.0dB MAX  
100~125MHZ -1.2dB MAX
- 5.0 RETURN LOSS: 1~40MHZ -16dB MIN  
40~60MHZ -12dB MIN  
60~80MHZ -10dB MIN  
80~100MHZ -8dB MIN
- 6.0 CROSS TALK: 1~100MHZ -30dB MIN
- 7.0 COMMON TO COMMON MODE ATTENUATION: 1~100MHZ -30dB MIN
- 8.0 ISOLATION: PHY SIDE TO LINE SIDE: 2250VDC

LED SPECIFICATION:

STANDARDLED	WAVELENGTH	Forward Current	Forward V(max)	TYP
GREEN	565nm	20 mA	2.4V	2.2V
YELLOW	590nm	20 mA	2.5V	2.1V

All rights reserved. Pulse confidential & proprietary. (05/15/15)

TLA DRAWING	PS DRAWING	SHEET	PART NO.	DATASHEET REV.
XD3-0002NL-X1	-	2 OF 5	JXD3-0002NL	A

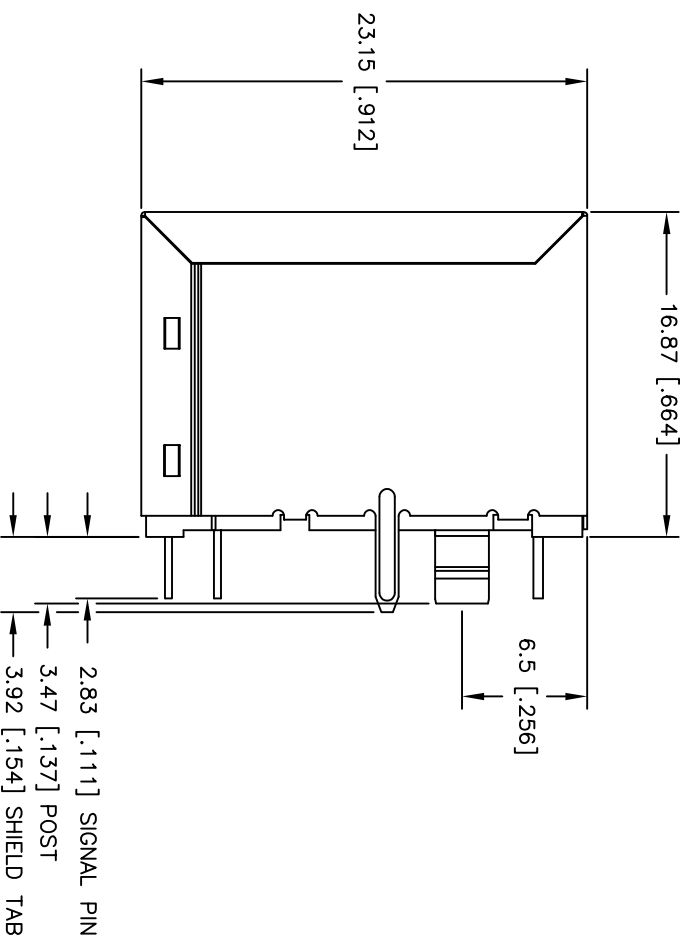

DIMENSIONS ARE IN MILLIMETERS [INCHES] WITH THE FOLLOWING  
TOLERANCES: [INCHES] ARE FOR REFERENCE ONLY.  
X.XX =  $\pm 0.25$  [ $\pm 0.010$ ]

All rights reserved. Pulse confidential & proprietary. (05/15/15)

TLA DRAWING	PS DRAWING	SHEET	PART NO.	DATASHEET REV.
XD3-0002NL-X1	-	3 OF 5	JXD3-0002NL	A

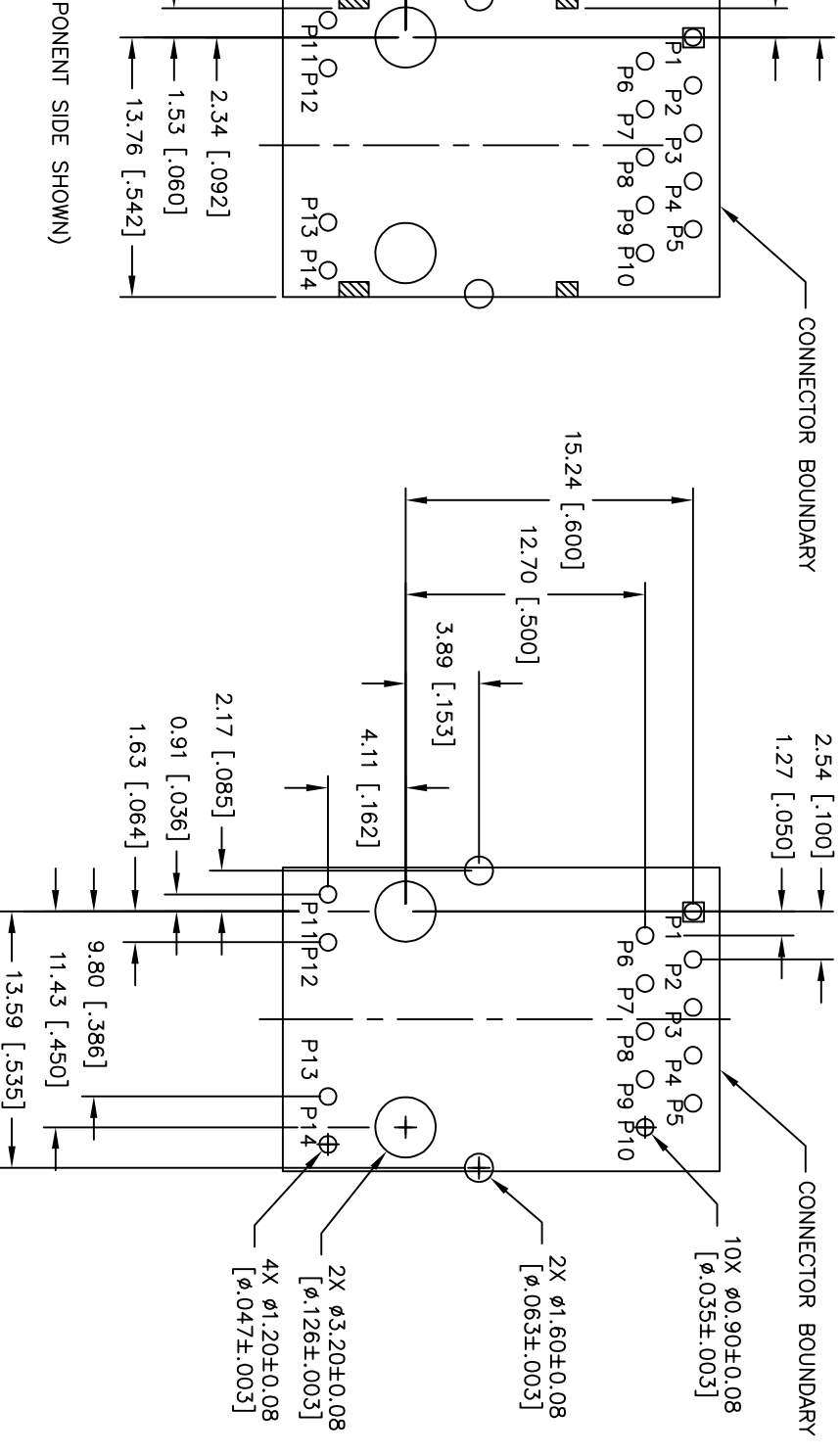

WITH THE FOLLOWING  
STATEMENT OF CONFIDENTIALITY AND PROPRIETARY RIGHTS.

All rights reserved. Pulse confidential & proprietary. (05/15/15)

RECOMMENDED PWB LAYOUT  
(COMPONENT SIDE SHOWN)

TLA DRAWING	PS DRAWING	SHEET	PART NO.	DATASHEET REV.
XD3-0002NL-X1	-	4 OF 5	JXD3-0002NL	A

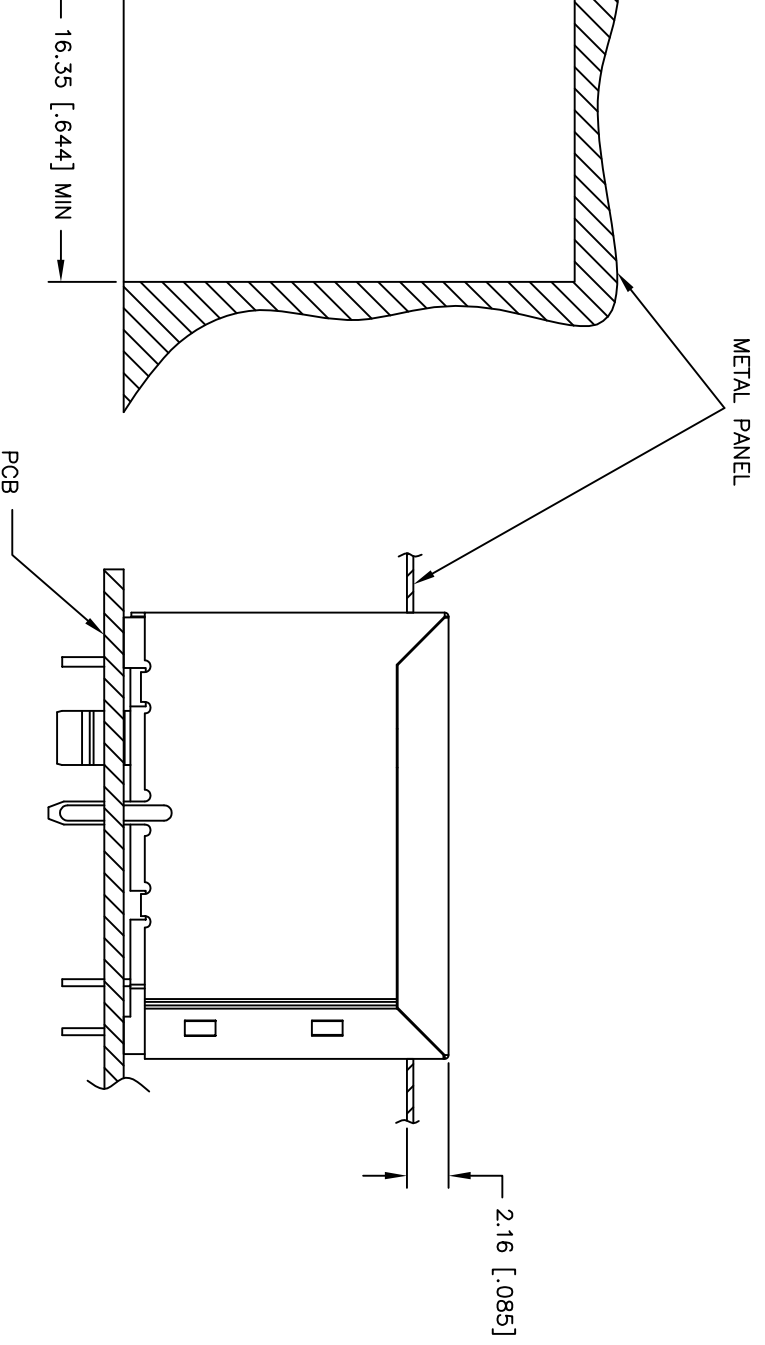



WITH THE FOLLOWING  
 NCE ONLY.

All rights reserved. Pulse confidential & proprietary. (05/15/15)

TLA DRAWING	PS DRAWING	SHEET	PART NO.	DATASHEET REV.
XD3-0002NL-X1	-	5 OF 5	JXD3-0002NL	A

## Looking for pricing, stock, or lifecycle information?

Click below to explore more details on WIN SOURCE:

-  [View JXD3-0002NL on WIN SOURCE](#)
-  [Pulse Information](#)

## Optimize Your Supply Chain with WIN SOURCE Solutions

-  Global Sourcing Solution
-  Obsolete Management
-  Cost Control Management
-  Shortage Management
-  Alternative Solution
-  Excess Inventory Management