



**THE DATASHEET OF
JXD1-0005NL**



NOTES:

1. CONNECTOR MATERIAL:
HOUSING: PA66 BLACK UL94 V-0
SHIELD: Brass
SHIELD PLATING: NICKEL
CONTACT: COOPER ALLOY
CONTACT PLATING: SELECTIVE GOLD, 30 MICRO-INCHES MIN IN CONTACT AREA
2. PIN NOT ELECTRICALLY CONNECTED MAYBE OMITTED SEE ELECTRICAL DRAWING FOR OMITTED PINS
3. RJ45 CAVITIES CONFORM TO FCC RULES AND REGULATION PART 68.
4. THE PART IS RECOMMENDED FOR WAVE SOLDERING PROCESS PEAK SOLDERING TEMPERATURE IS 260°C MAX, 10 SECS MAX
5. OPERATING TEMPERATURE T=-40°C TO +85°C.
6. STORAGE TEMPERATURE T=-40°C TO +85°C.
7. ALL CRITICAL DIMENSIONS WITH "*"
8. PACKAGING INFORMATION: 50 PCS/ TRAY, 1200 PCS/BOX.

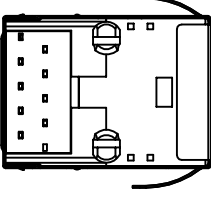
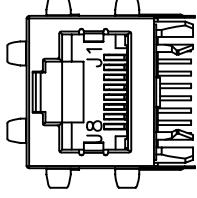
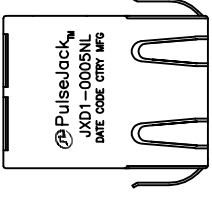

© Copyright, 2015. Pulse Electronics Corp. All rights reserved. Pulse confidential & proprietary. (03/02/15)

PRODUCT DESCRIPTION	TLA DRAWING	PS DRAWING	SHEET
CONN,RJ45,1X1,100P,1:1,TU	JXD1-0005NL-X1	-	1 OF 5

E-MAIL: PRODINFONETWORK@PULSEELECTRONICS.COM(US). ASIA@PULSEELECTRONICS.COM(Asia)

PHONE: USA:858 674 8100, GERMANY:49 7032 78060, SINGAPORE:65 6

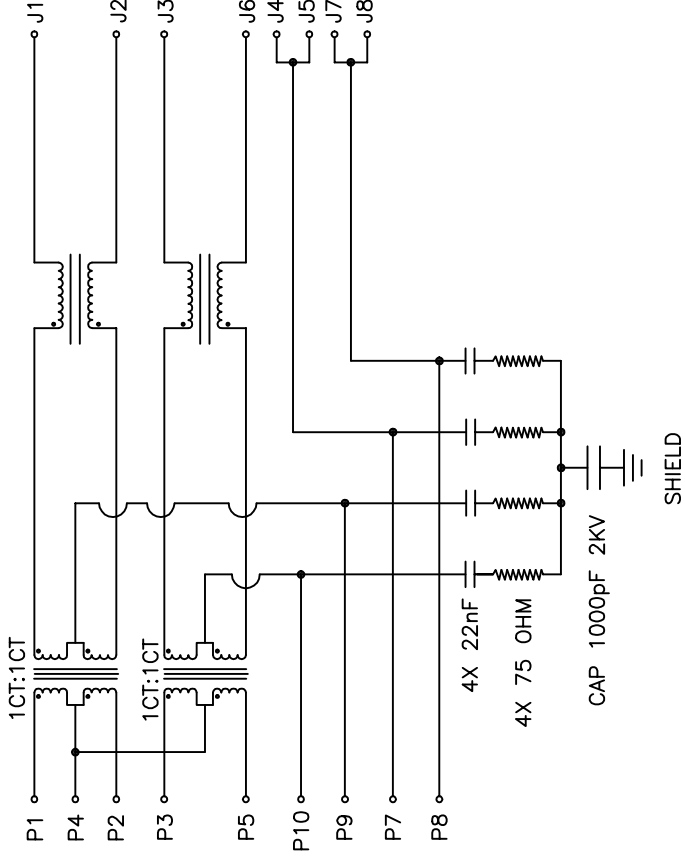

ELECTRONICAL SPECIFICATIONS:

- 1.0 TURN RATIO @100KHZ: (f) (f)
- 2.0 PRIMARY INDUCTANCE: 350uH
- 3.0 DC RESISTANCE: (J1~J2):(J3~J6)
- 4.0 INSERTION LOSS: 1-100dB
- 5.0 RETURN LOSS: 1-30dB
30-60dB
60-80dB
- 6.0 CROSS TALK: 1-100dB
- 7.0 COMMON TO COMMON MODE REJECTION: 1-100dB
- 8.0 ISOLATION: PHY SIDE TO LIN SIDE
- 9.0 DC CURRENT/VOLTAGE RATING: 100mA/100V

© Copyright, 2015. Pulse Electronics Corp. All rights reserved. Pulse confidential & proprietary. (03/02/15)

PRODUCT DESCRIPTION	TLA DRAWING	PS DRAWING	SHEET
CONN,RJ45,1X1,100P,1:1,TU	JXD1-0005NL-X1	-	2 OF 5

E-MAIL: PRODINFONETWORK@PULSEELECTRONICS.COM(US). ASIA@PULSEELECTRONICS.COM(Asia)

PHONE: USA:858 674 8100, GERMANY:49 7032 78060, SINGAPORE:65 6349 8888

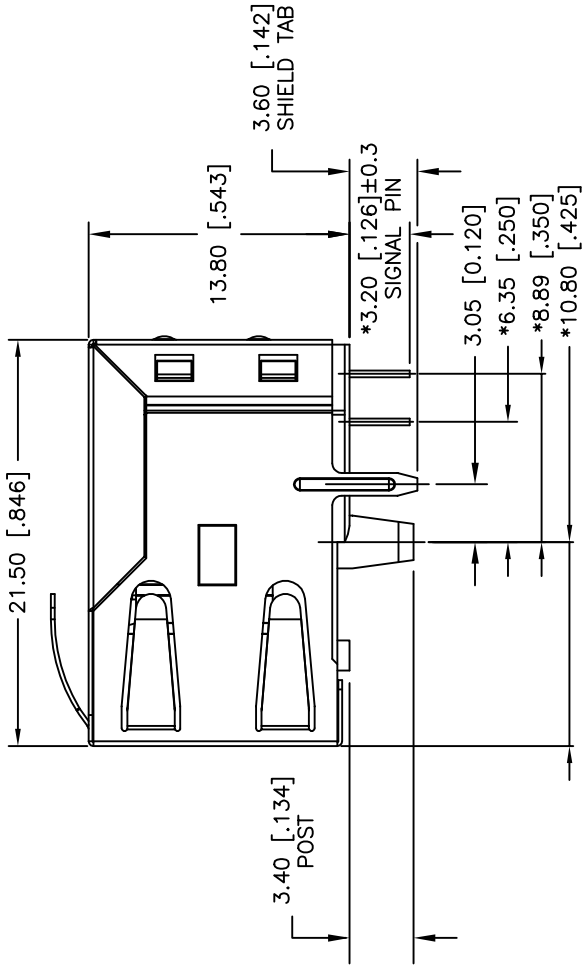
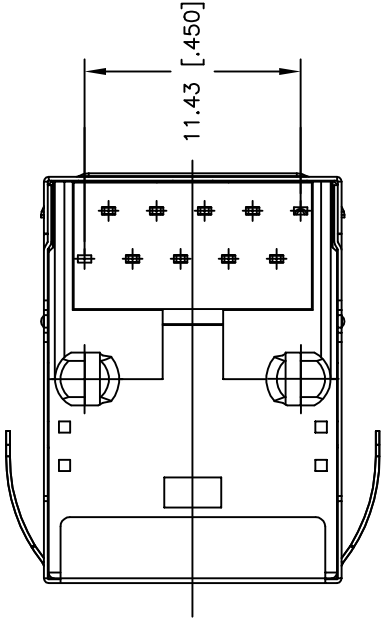

DIMENSIONS ARE IN MILLIMETERS [INCHES] WITH THE FOLLOWING TOLERANCES: [INCHES] ARE FOR REFERENCE ONLY.
X.XX= ±0.25 [±.010]

© Copyright, 2015. Pulse Electronics Corp. All rights reserved. Pulse confidential & proprietary. (03/02/15)

PRODUCT DESCRIPTION	TLA DRAWING	PS DRAWING	SHEET
CONN,RJ45,1X1,100P,1:1,TU	JXD1-0005NL-X1	-	3 OF 5

E-MAIL: PRODINFONETWORK@PULSEELECTRONICS.COM(US). ASIA@PULSEELECTRONICS.COM(Asia)

PHONE: USA:858 674 8100, GERMANY:49 7032 78060, SINGAPORE:65 6

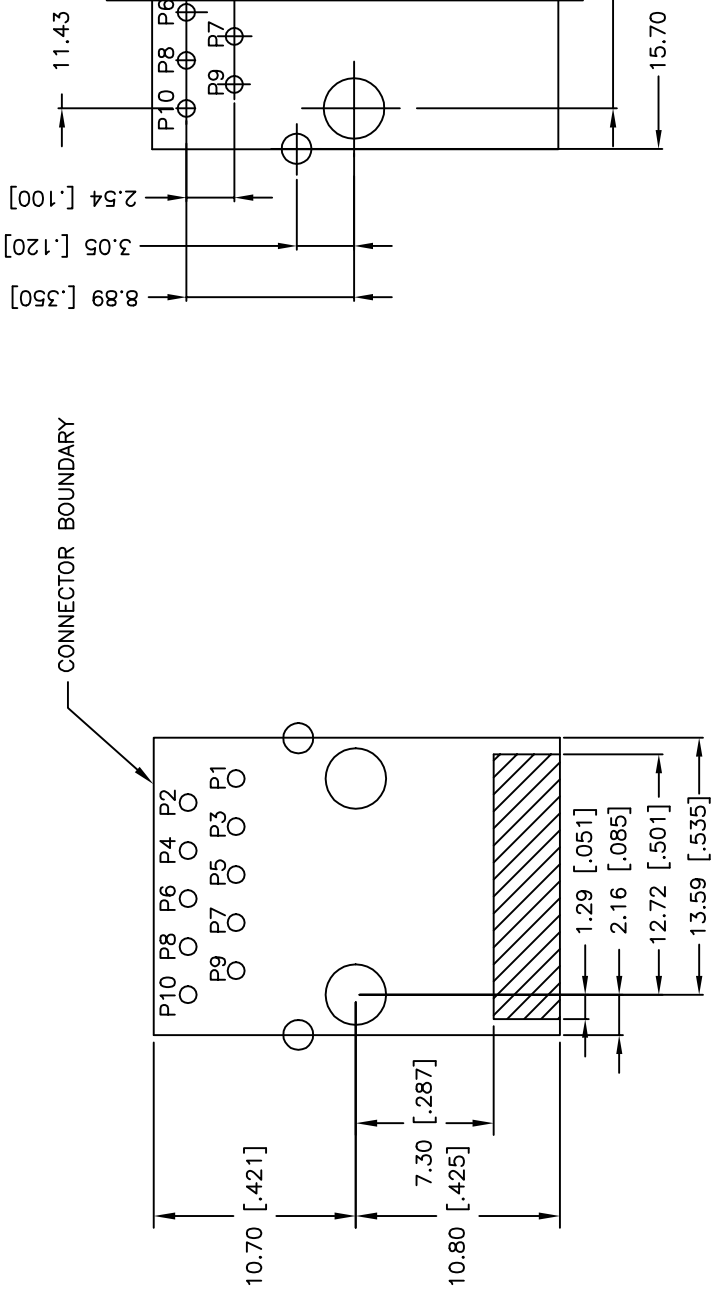

KEEP-OUT AREA (COMPONENT SIDE SHOWN)

RECOMMENDED
(COMPONENT)

DIMENSIONS ARE IN MILLIMETERS [INCHES] WITH THE FOLLOWING TOLERANCES: [INCHES] ARE FOR REFERENCE ONLY.
X.XX = ± 0.10 [± 0.004]

© Copyright, 2015. Pulse Electronics Corp. All rights reserved. Pulse confidential & proprietary. (03/02/15)

PRODUCT DESCRIPTION	TLA DRAWING	PS DRAWING	SHEET
CONN,RJ45,1X1,100P,1:1,TU	JXD1-0005NL-X1	-	4 OF 5

E-MAIL: PRODINFONETWORK@PULSEELECTRONICS.COM(US). ASIA@PULSEELECTRONICS.COM(Asia)

PHONE: USA:858 674 8100, GERMANY:49 7032 78060, SINGAPORE:65 6

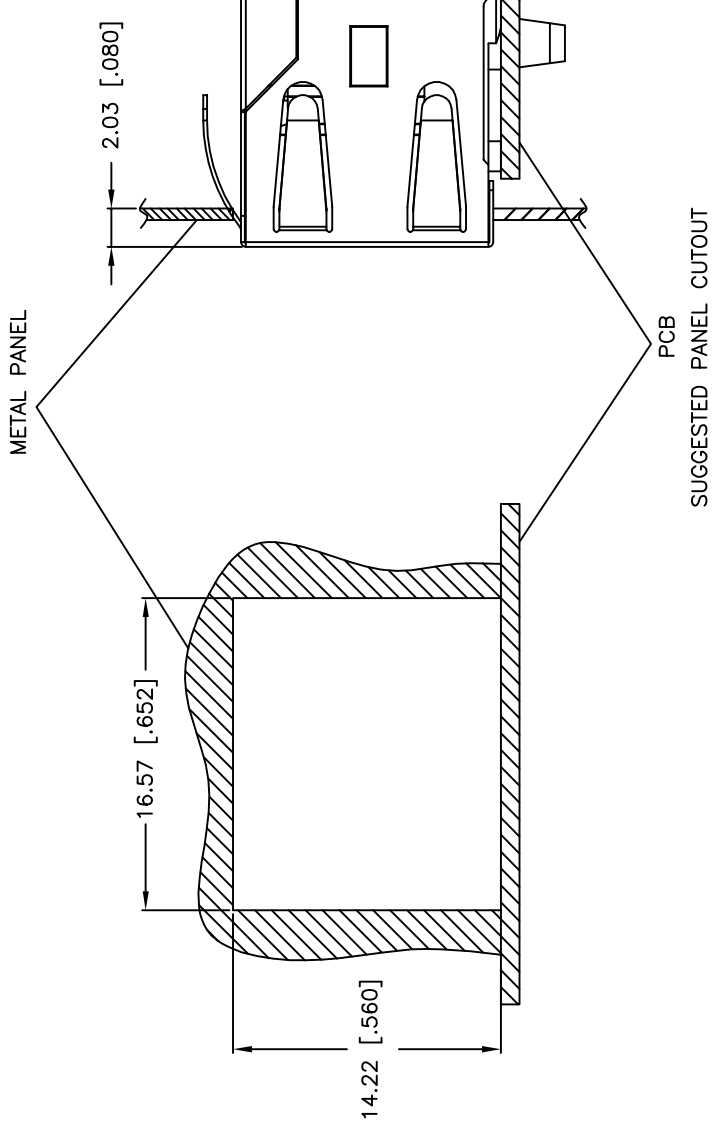

DIMENSIONS ARE IN MILLIMETERS [INCHES] WITH THE FOLLOWING TOLERANCES: [INCHES] ARE FOR REFERENCE ONLY.
 X.XX = ± 0.10 [± 0.004]

© Copyright, 2015. Pulse Electronics Corp. All rights reserved. Pulse confidential & proprietary. (03/02/15)



PRODUCT DESCRIPTION	TLA DRAWING	PS DRAWING	SHEET
CONN,RJ45,1X1,100P,1:1,TU	JXD1-0005NL-X1	-	5 OF 5

E-MAIL: PRODINFONETWORK@PULSEELECTRONICS.COM(US). ASIA@PULSEELECTRONICS.COM(Asia)

PHONE: USA:858 674 8100, GERMANY:49 7032 78060, SINGAPORE:65 6

Looking for pricing, stock, or lifecycle information?

Click below to explore more details on WIN SOURCE:

-  [View JXD1-0005NL on WIN SOURCE](#)
-  [Pulse Information](#)

Optimize Your Supply Chain with WIN SOURCE Solutions

-  Global Sourcing Solution
-  Obsolete Management
-  Cost Control Management
-  Shortage Management
-  Alternative Solution
-  Excess Inventory Management