

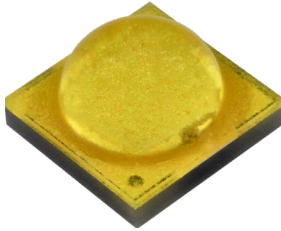

**THE DATASHEET OF
XPGDWT-H1-0000-00KE3**



XLamp® XP-G3 LEDs



XP-G3 White

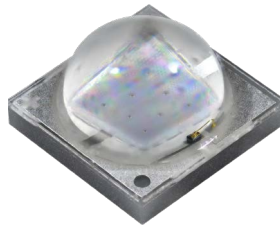

XP-G3 Royal Blue

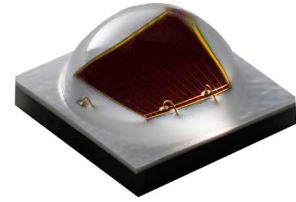

XP-G3 Photo Red

PRODUCT DESCRIPTION

XLamp® XP-G3 LEDs are optimized for directional, high-lumen lighting applications where efficacy and optical control are critical, such as roadway, portable and horticulture. The compact and proven 3.45-mm XP platform has an excellent ecosystem of optics and system solutions available, enabling lighting manufacturers to simplify their design process and shorten time-to-market.

XP-G3 LEDs are available in and two different White, Royal Blue and Photo Red versions: Standard & S Line. The White Standard version delivers best-in-class TM-21 lifetimes and color stability over time. The S Line versions of White, Royal Blue and Photo Red deliver improved efficiency, best-in-class sulfur resistance and better system-level reliability through switching and dimming cycles. With these S Line versions, Cree LED delivers high-power LED technology that is optimized for both general and horticulture lighting applications where sensors and switching are becoming common.

In this document, the terms White, Royal Blue and Photo Red denote the white, royal blue or photo red XP-G3 LED without regard to its Standard or S Line features. The terms Standard and S Line are used when necessary to differentiate the performance of the Standard XP-G3 LED from the XP-G3 LED with the S Line option.

FEATURES

- Available in no CRI minimum white, 70-, 80- and 90-CRI white, royal blue & photo red
- Broadcast color option at 5700 K
- ANSI-compatible chromaticity bins
- 3-step and 5-step options
- White binned at 85 °C, royal blue & photo red binned at 25 °C
- Maximum drive current: white, royal blue: 2000 mA, photo red: 1500 mA
- Low thermal resistance: white: 1.1 °C/W, royal blue: 0.9 °C/W, photo red: 1.2 °C/W
- Wide viewing angle: 123°–130°
- Unlimited floor life at ≤ 30 °C/85% RH
- Reflow solderable - JEDEC J-STD-020C
- Electrically neutral thermal path
- RoHS and REACH compliant
- UL® recognized component (E349212)



Cree LED / 4001 E. Hwy. 54, Suite 2000 / Durham, NC 27709 USA / +1.919.313.5330 / www.cree-led.com

TABLE OF CONTENTS

| | |
|---|----|
| Characteristics | 3 |
| Order Codes Suggested for New Designs - White (Standard) | 4 |
| Order Codes Suggested for New Designs - White (S Line) | 10 |
| Flux Characteristics - Color (Standard) | 13 |
| Flux Characteristics - Color (S Line) | 14 |
| Flux Characteristics - Broadcast Order Codes and Bins..... | 14 |
| Relative Spectral Power Distribution - White (Standard) | 15 |
| Relative Spectral Power Distribution - White (S Line) | 15 |
| Relative Spectral Power Distribution - Color | 16 |
| Relative Flux vs. Junction Temperature - White (Standard) | 16 |
| Relative Flux vs. Junction Temperature - White (S Line) | 17 |
| Relative Flux vs. Junction Temperature - Color..... | 17 |
| Electrical Characteristics - White (Standard) | 18 |
| Electrical Characteristics - White (S Line) | 18 |
| Electrical Characteristics - Color..... | 19 |
| Relative Luminous Flux vs. Current - White (Standard) | 19 |
| Relative Luminous Flux vs. Current - White (S Line) | 20 |
| Relative Radiant Flux vs. Current - Color | 20 |
| Relative Chromaticity vs. Current and Temperature | 21 |
| Typical Spatial Distribution - White (Standard) | 22 |
| Typical Spatial Distribution - White (S Line) | 22 |
| Typical Spatial Distribution - Color..... | 23 |
| Thermal Design..... | 24 |
| Performance Groups - Luminous Flux..... | 25 |
| Performance Groups - Radiant Flux..... | 26 |
| Performance Groups - Peak Wavelength..... | 27 |
| Performance Groups - Forward Voltage..... | 27 |
| Performance Groups - Chromaticity | 28 |
| Standard Cool White Kits Plotted on ANSI Standard Chromaticity Regions..... | 32 |
| Standard Warm and Neutral White Kits Plotted on ANSI Standard Chromaticity Regions..... | 33 |
| EasyWhite® White Kits Plotted on ANSI Standard Chromaticity Regions | 35 |
| Standard Chromaticity Kits | 36 |
| Bin and Order Code Formats..... | 37 |
| Reflow Soldering Characteristics..... | 38 |
| Notes | 39 |
| Mechanical Dimensions | 41 |
| Tape and Reel..... | 43 |
| Packaging..... | 45 |
| Appendix - Order Codes Not For New Designs | 46 |

CHARACTERISTICS

| Characteristics | Unit | Minimum | Typical | Maximum |
|--|---------|---------|----------|---------|
| Thermal resistance, junction to solder point - white [Ⓞ] | °C/W | | 1.1 | |
| Thermal resistance, junction to solder point - royal blue [Ⓞ] | °C/W | | 0.9 | |
| Thermal resistance, junction to solder point - photo red [Ⓞ] | °C/W | | 1.2 | |
| Viewing angle (FWHM) - white | degrees | | 125 | |
| Viewing angle (FWHM) - royal blue | degrees | | 130 | |
| Viewing angle (FWHM) - photo red | degrees | | 123 | |
| Temperature coefficient of voltage - royal blue | mV/°C | | -1.6 | |
| Temperature coefficient of voltage - photo red | mV/°C | | -0.9 | |
| ESD withstand voltage (HBM per Mil-Std-883D) | | | Class 3B | |
| DC forward current - white, royal blue | mA | | | 2000 |
| DC forward current - photo red | mA | | | 1500 |
| Reverse voltage | V | | | 1 |
| Forward voltage (@ 350 mA, 85 °C) - white | V | | 2.70 | 2.90 |
| Forward voltage (@ 350 mA, 25 °C) - royal blue | V | | 2.79 | 3.0 |
| Forward voltage (@ 350 mA, 25 °C) - photo red (Standard) | V | | 1.99 | 2.2 |
| Forward voltage (@ 350 mA, 25 °C) - photo red (S Line) | V | | 1.87 | 2.2 |
| Forward voltage (@ 700 mA, 85 °C) - white | V | | 2.80 | |
| Forward voltage (@ 700 mA, 25 °C) - royal blue | V | | 2.90 | |
| Forward voltage (@ 700 mA, 25 °C) - photo red (Standard) | V | | 2.18 | |
| Forward voltage (@ 700 mA, 25 °C) - photo red (S Line) | V | | 1.98 | |
| Forward voltage (@ 1000 mA, 85 °C) - white | V | | 2.87 | |
| Forward voltage (@ 1000 mA, 25 °C) - royal blue | V | | 2.99 | |
| Forward voltage (@ 1000 mA, 25 °C) - photo red (Standard) | V | | 2.36 | |
| Forward voltage (@ 1000 mA, 25 °C) - photo red (S Line) | V | | 2.06 | |
| Forward voltage (@ 1500 mA, 85 °C) - white | V | | 2.97 | |
| Forward voltage (@ 1500 mA, 25 °C) - royal blue | V | | 3.11 | |
| Forward voltage (@ 1500 mA, 25 °C) - photo red (Standard) | V | | 2.65 | |
| Forward voltage (@ 1500 mA, 25 °C) - photo red (S Line) | V | | 2.19 | |
| Forward voltage (@ 2000 mA, 85 °C) - white | V | | 3.06 | |
| Forward voltage (@ 2000 mA, 25 °C) - royal blue | V | | 3.20 | |
| LED junction temperature | °C | | | 150 |

Note:

- Ⓞ Thermal resistance measurement was performed per the JEDEC JESD51-14 standard. See the [Thermal Resistance Measurement application note](#) for more details.

ORDER CODES SUGGESTED FOR NEW DESIGNS - WHITE (STANDARD) - $T_j = 85\text{ }^\circ\text{C}$

The following table provides order codes for XLamp XP-G3 White (Standard) LEDs. For a complete description of the order code nomenclature, please see the Bin and Order Code Formats section (page 37). For definitions of the chromaticity kits, please see the Standard Chromaticity Kits section (page 36).

| Chromaticity | | Minimum Luminous Flux (lm) @ 350 mA | | | Order Codes | | | |
|--------------|---------|-------------------------------------|-------------------|--------------------|----------------------|----------------------|----------------------|----------------------|
| Kit | CCT | Code | Flux (lm) @ 85 °C | Flux (lm) @ 25 °C* | 70 CRI Typical | 70 CRI Minimum | 80 CRI Minimum | 90 CRI Minimum |
| DT | 7000 K | S6 | 180 | 196 | | XPGDWT-B1-0000-00NDT | | |
| | | S5 | 172 | 187 | XPGDWT-01-0000-00MDT | XPGDWT-B1-0000-00MDT | | |
| | | S4 | 164 | 179 | XPGDWT-01-0000-00LDT | XPGDWT-B1-0000-00LDT | XPGDWT-H1-0000-00LDT | |
| | | S3 | 156 | 170 | XPGDWT-01-0000-00KDT | XPGDWT-B1-0000-00KDT | XPGDWT-H1-0000-00KDT | |
| | | S2 | 148 | 161 | XPGDWT-01-0000-00JDT | | | |
| CB | 6500 K | S4 | 164 | 179 | | | XPGDWT-H1-0000-00LCB | |
| | | S3 | 156 | 170 | | | XPGDWT-H1-0000-00KCB | |
| E0 | >6500 K | S5 | 172 | 187 | XPGDWT-01-0000-00ME0 | XPGDWT-B1-0000-00ME0 | | |
| | | S4 | 164 | 179 | XPGDWT-01-0000-00LE0 | XPGDWT-B1-0000-00LE0 | | |
| | | S3 | 156 | 170 | | XPGDWT-B1-0000-00KE0 | XPGDWT-H1-0000-00KE0 | |
| E1 | 6500 K | S5 | 172 | 187 | XPGDWT-01-0000-00ME1 | XPGDWT-B1-0000-00ME1 | | |
| | | S4 | 164 | 179 | XPGDWT-01-0000-00LE1 | XPGDWT-B1-0000-00LE1 | XPGDWT-H1-0000-00LE1 | |
| | | S3 | 156 | 170 | | XPGDWT-B1-0000-00KE1 | XPGDWT-H1-0000-00KE1 | |
| DV | 6000 K | S6 | 180 | 196 | | XPGDWT-B1-0000-00NDV | | |
| | | S5 | 172 | 187 | XPGDWT-01-0000-00MDV | XPGDWT-B1-0000-00MDV | | |
| | | S4 | 164 | 179 | XPGDWT-01-0000-00LDV | XPGDWT-B1-0000-00LDV | XPGDWT-H1-0000-00LDV | |
| | | S3 | 156 | 170 | | XPGDWT-B1-0000-00KDV | XPGDWT-H1-0000-00KDV | |
| | | S2 | 148 | 161 | | | | XPGDWT-U1-0000-00JDV |
| | | R5 | 139 | 152 | | | | XPGDWT-U1-0000-00HDV |
| | | R4 | 130 | 142 | | | | XPGDWT-U1-0000-00GDV |
| 50 | 6000 K | S5 | 172 | 187 | XPGDWT-01-0000-00M50 | XPGDWT-B1-0000-00M50 | | |
| | | S4 | 164 | 179 | XPGDWT-01-0000-00L50 | XPGDWT-B1-0000-00L50 | XPGDWT-H1-0000-00L50 | |
| | | S3 | 156 | 170 | | XPGDWT-B1-0000-00K50 | XPGDWT-H1-0000-00K50 | |
| | | S2 | 148 | 161 | | | | XPGDWT-U1-0000-00J50 |
| | | R5 | 139 | 152 | | | | XPGDWT-U1-0000-00H50 |
| | | R4 | 130 | 142 | | | | XPGDWT-U1-0000-00G50 |

Notes

- Cree LED maintains a tolerance of $\pm 7\%$ on flux and power measurements, ± 0.005 on chromaticity (CCx, CCy) measurements and a tolerance of ± 2 on CRI measurements. See the Measurements section (page 39).
- XLamp XP-G3 LED order codes specify only a minimum flux bin and not a maximum. Cree LED may ship reels in flux bins higher than the minimum specified by the order code without advance notice. Shipments will always adhere to the chromaticity bin restrictions specified by the order code.
- * Flux values @ 25 °C are calculated and for reference only.

ORDER CODES SUGGESTED FOR NEW DESIGNS - WHITE (STANDARD) - T_j = 85 °C (CONTINUED)

| Chromaticity | | Minimum Luminous Flux (lm) @ 350 mA | | | Order Codes | | | |
|--------------|--------|-------------------------------------|-------------------|--------------------|----------------------|----------------------|----------------------|-----------------------|
| Kit | CCT | Code | Flux (lm) @ 85 °C | Flux (lm) @ 25 °C* | 70 CRI Typical | 70 CRI Minimum | 80 CRI Minimum | 90 CRI Minimum |
| E2 | 5700 K | S6 | 180 | 196 | XPGDWT-01-0000-00NE2 | XPGDWT-B1-0000-00NE2 | | |
| | | S5 | 172 | 187 | XPGDWT-01-0000-00ME2 | XPGDWT-B1-0000-00ME2 | | |
| | | S4 | 164 | 179 | XPGDWT-01-0000-00LE2 | XPGDWT-B1-0000-00LE2 | XPGDWT-H1-0000-00LE2 | |
| | | S3 | 156 | 170 | | XPGDWT-B1-0000-00KE2 | XPGDWT-H1-0000-00KE2 | |
| | | S2 | 148 | 161 | | | | XPGDWT-U1-0000-00JE2 |
| | | R5 | 139 | 152 | | | | XPGDWT-U1-0000-00HE2 |
| | | R4 | 130 | 142 | | | | XPGDWT-U1-0000-00GE2 |
| 2E | 5700 K | S6 | 180 | 196 | | XPGDWT-B1-0000-00N2E | | |
| | | S5 | 172 | 187 | | XPGDWT-B1-0000-00M2E | | |
| | | S4 | 164 | 179 | | XPGDWT-B1-0000-00L2E | XPGDWT-H1-0000-00L2E | |
| | | S3 | 156 | 170 | | XPGDWT-B1-0000-00K2E | XPGDWT-H1-0000-00K2E | |
| | | S2 | 148 | 161 | | | | XPGDWT-U1-0000-00J2E |
| | | R5 | 139 | 152 | | | | XPGDWT-U1-0000-00H2E |
| | | R4 | 130 | 142 | | | | XPGDWT-U1-0000-00G2E |
| 3E | 5000 K | S6 | 180 | 196 | | XPGDWT-B1-0000-00N3E | | |
| | | S5 | 172 | 187 | | XPGDWT-B1-0000-00M3E | | |
| | | S4 | 164 | 179 | | XPGDWT-B1-0000-00L3E | XPGDWT-H1-0000-00L3E | |
| | | S3 | 156 | 170 | | XPGDWT-B1-0000-00K3E | XPGDWT-H1-0000-00K3E | |
| | | S2 | 148 | 161 | | | | XPGDWT-U1-0000-00J3E |
| | | R5 | 139 | 152 | | | | XPGDWT-U1-0000-00H3E |
| | | R4 | 130 | 142 | | | | XPGDWT-U1-0000-00G4E |
| E3 | 5000 K | S6 | 180 | 196 | XPGDWT-01-0000-00NE3 | XPGDWT-B1-0000-00NE3 | | |
| | | S5 | 172 | 187 | XPGDWT-01-0000-00ME3 | XPGDWT-B1-0000-00ME3 | | |
| | | S4 | 164 | 179 | XPGDWT-01-0000-00LE3 | XPGDWT-B1-0000-00LE3 | XPGDWT-H1-0000-00LE3 | |
| | | S3 | 156 | 170 | | | XPGDWT-H1-0000-00KE3 | |
| | | S2 | 148 | 161 | | | | XPGDWT-U1-0000-00EJE3 |
| | | R5 | 139 | 152 | | | | XPGDWT-U1-0000-00HE3 |
| | | R4 | 130 | 142 | | | | XPGDWT-U1-0000-00GE3 |

Notes

- Cree LED maintains a tolerance of ±7% on flux and power measurements, ±0.005 on chromaticity (CCx, CCy) measurements and a tolerance of ±2 on CRI measurements. See the Measurements section (page 39).
- XLamp XP-G3 LED order codes specify only a minimum flux bin and not a maximum. Cree LED may ship reels in flux bins higher than the minimum specified by the order code without advance notice. Shipments will always adhere to the chromaticity bin restrictions specified by the order code.
- * Flux values @ 25 °C are calculated and for reference only.

ORDER CODES SUGGESTED FOR NEW DESIGNS - WHITE (STANDARD) - T_j = 85 °C (CONTINUED)

| Chromaticity | | Minimum Luminous Flux (lm) @ 350 mA | | | Order Codes | | | |
|--------------|--------|-------------------------------------|-------------------|--------------------|----------------------|----------------------|----------------------|----------------------|
| Kit | CCT | Code | Flux (lm) @ 85 °C | Flux (lm) @ 25 °C* | 70 CRI Typical | 70 CRI Minimum | 80 CRI Minimum | 90 CRI Minimum |
| F4 | 4750 K | S6 | 180 | 196 | XPGDWT-01-0000-00NF4 | XPGDWT-B1-0000-00NF4 | | |
| | | S5 | 172 | 187 | XPGDWT-01-0000-00MF4 | XPGDWT-B1-0000-00MF4 | | |
| | | S4 | 164 | 179 | XPGDWT-01-0000-00LF4 | XPGDWT-B1-0000-00LF4 | XPGDWT-H1-0000-00LF4 | |
| | | S3 | 156 | 170 | | | XPGDWT-H1-0000-00KF4 | |
| | | S2 | 148 | 161 | | | XPGDWT-H1-0000-00JF4 | XPGDWT-U1-0000-00JF4 |
| | | R5 | 139 | 152 | | | | XPGDWT-U1-0000-00HF4 |
| | | R4 | 130 | 142 | | | | XPGDWT-U1-0000-00GF4 |
| 4E | 4500 K | S6 | 180 | 196 | | XPGDWT-B1-0000-00N4E | | |
| | | S5 | 172 | 187 | | XPGDWT-B1-0000-00M4E | | |
| | | S4 | 164 | 179 | | XPGDWT-B1-0000-00L4E | XPGDWT-H1-0000-00L4E | |
| | | S3 | 156 | 170 | | | XPGDWT-H1-0000-00K4E | |
| | | S2 | 148 | 161 | | | XPGDWT-H1-0000-00J4E | XPGDWT-U1-0000-00J4E |
| | | R5 | 139 | 152 | | | | XPGDWT-U1-0000-00H4E |
| | | R4 | 130 | 142 | | | | XPGDWT-U1-0000-00G4E |
| E4 | 4500 K | S6 | 180 | 196 | XPGDWT-01-0000-00NE4 | XPGDWT-B1-0000-00NE4 | | |
| | | S5 | 172 | 187 | XPGDWT-01-0000-00ME4 | XPGDWT-B1-0000-00ME4 | | |
| | | S4 | 164 | 179 | XPGDWT-01-0000-00LE4 | XPGDWT-B1-0000-00LE4 | XPGDWT-H1-0000-00LE4 | |
| | | S3 | 156 | 170 | | | XPGDWT-H1-0000-00KE4 | |
| | | S2 | 148 | 161 | | | XPGDWT-H1-0000-00JE4 | XPGDWT-U1-0000-00JE4 |
| | | R5 | 139 | 152 | | | | XPGDWT-U1-0000-00HE4 |
| | | R4 | 130 | 142 | | | | XPGDWT-U1-0000-00GE4 |
| F5 | 4200 K | S6 | 180 | 196 | | XPGDWT-B1-0000-00NF5 | | |
| | | S5 | 172 | 187 | XPGDWT-01-0000-00MF5 | XPGDWT-B1-0000-00MF5 | | |
| | | S4 | 164 | 179 | XPGDWT-01-0000-00LF5 | XPGDWT-B1-0000-00LF5 | XPGDWT-H1-0000-00LF5 | |
| | | S3 | 156 | 170 | | XPGDWT-B1-0000-00KF5 | XPGDWT-H1-0000-00KF5 | |
| | | S2 | 148 | 161 | | | XPGDWT-H1-0000-00JF5 | XPGDWT-U1-0000-00JF5 |
| | | R5 | 139 | 152 | | | | XPGDWT-U1-0000-00HF5 |
| | | R4 | 130 | 142 | | | | XPGDWT-U1-0000-00GF5 |

Notes

- Cree LED maintains a tolerance of ±7% on flux and power measurements, ±0.005 on chromaticity (CCx, CCy) measurements and a tolerance of ±2 on CRI measurements. See the Measurements section (page 39).
- XLamp XP-G3 LED order codes specify only a minimum flux bin and not a maximum. Cree LED may ship reels in flux bins higher than the minimum specified by the order code without advance notice. Shipments will always adhere to the chromaticity bin restrictions specified by the order code.
- * Flux values @ 25 °C are calculated and for reference only.

ORDER CODES SUGGESTED FOR NEW DESIGNS - WHITE (STANDARD) - T_j = 85 °C (CONTINUED)

| Chromaticity | | Minimum Luminous Flux (lm) @ 350 mA | | | Order Codes | | | |
|--------------|--------|-------------------------------------|-------------------|--------------------|----------------------|----------------------|----------------------|----------------------|
| Kit | CCT | Code | Flux (lm) @ 85 °C | Flux (lm) @ 25 °C* | 70 CRI Typical | 70 CRI Minimum | 80 CRI Minimum | 90 CRI Minimum |
| 5E | 4000 K | S6 | 180 | 196 | | XPGDWT-B1-0000-00N5E | | |
| | | S5 | 172 | 187 | | XPGDWT-B1-0000-00M5E | | |
| | | S4 | 164 | 179 | | XPGDWT-B1-0000-00L5E | XPGDWT-H1-0000-00L5E | |
| | | S3 | 156 | 170 | | XPGDWT-B1-0000-00K5E | XPGDWT-H1-0000-00K5E | |
| | | S2 | 148 | 161 | | | XPGDWT-H1-0000-00J5E | XPGDWT-U1-0000-00J5E |
| | | R5 | 139 | 152 | | | | XPGDWT-U1-0000-00H5E |
| | | R4 | 130 | 142 | | | | XPGDWT-U1-0000-00G5E |
| E5 | 4000 K | S6 | 180 | 196 | | XPGDWT-B1-0000-00NE5 | | |
| | | S5 | 172 | 187 | XPGDWT-01-0000-00ME5 | XPGDWT-B1-0000-00ME5 | | |
| | | S4 | 164 | 179 | XPGDWT-01-0000-00LE5 | XPGDWT-B1-0000-00LE5 | XPGDWT-H1-0000-00LE5 | |
| | | S3 | 156 | 170 | | XPGDWT-B1-0000-00KE5 | XPGDWT-H1-0000-00KE5 | |
| | | S2 | 148 | 161 | | | XPGDWT-H1-0000-00JE5 | XPGDWT-U1-0000-00JE5 |
| | | R5 | 139 | 152 | | | | XPGDWT-U1-0000-00HE5 |
| | | R4 | 130 | 142 | | | | XPGDWT-U1-0000-00GE5 |
| F6 | 3700 K | S5 | 172 | 187 | | XPGDWT-B1-0000-00MF6 | | |
| | | S4 | 164 | 179 | XPGDWT-01-0000-00LF6 | XPGDWT-B1-0000-00LF6 | | |
| | | S3 | 156 | 170 | XPGDWT-01-0000-00KF6 | XPGDWT-B1-0000-00KF6 | XPGDWT-H1-0000-00KF6 | |
| | | S2 | 148 | 161 | | | XPGDWT-H1-0000-00JF6 | |
| | | R5 | 139 | 152 | | | XPGDWT-H1-0000-00HF6 | XPGDWT-U1-0000-00HF6 |
| | | R4 | 130 | 142 | | | | XPGDWT-U1-0000-00GF6 |
| 6E | 3500 K | S5 | 172 | 187 | | XPGDWT-B1-0000-00M6E | | |
| | | S4 | 164 | 179 | | XPGDWT-B1-0000-00L6E | | |
| | | S3 | 156 | 170 | | XPGDWT-B1-0000-00K6E | XPGDWT-H1-0000-00K6E | |
| | | S2 | 148 | 161 | | | XPGDWT-H1-0000-00J6E | |
| | | R5 | 139 | 152 | | | XPGDWT-H1-0000-00H6E | XPGDWT-U1-0000-00H6E |
| | | R4 | 130 | 142 | | | | XPGDWT-U1-0000-00G6E |
| 6G | 3500 K | R5 | 139 | 152 | | | | XPGDWT-U1-0000-00H6G |
| | | R4 | 130 | 142 | | | | XPGDWT-U1-0000-00G6G |

Notes

- Cree LED maintains a tolerance of ±7% on flux and power measurements, ±0.005 on chromaticity (CCx, CCy) measurements and a tolerance of ±2 on CRI measurements. See the Measurements section (page 39).
- XLamp XP-G3 LED order codes specify only a minimum flux bin and not a maximum. Cree LED may ship reels in flux bins higher than the minimum specified by the order code without advance notice. Shipments will always adhere to the chromaticity bin restrictions specified by the order code.
- * Flux values @ 25 °C are calculated and for reference only.

ORDER CODES SUGGESTED FOR NEW DESIGNS - WHITE (STANDARD) - T_J = 85 °C (CONTINUED)

| Chromaticity | | Minimum Luminous Flux (lm) @ 350 mA | | | Order Codes | | | |
|--------------|--------|-------------------------------------|-------------------|--------------------|----------------------|----------------------|----------------------|----------------------|
| Kit | CCT | Code | Flux (lm) @ 85 °C | Flux (lm) @ 25 °C* | 70 CRI Typical | 70 CRI Minimum | 80 CRI Minimum | 90 CRI Minimum |
| E6 | 3500 K | S5 | 172 | 187 | | XPGDWT-B1-0000-00ME6 | | |
| | | S4 | 164 | 179 | XPGDWT-01-0000-00LE6 | XPGDWT-B1-0000-00LE6 | | |
| | | S3 | 156 | 170 | XPGDWT-01-0000-00KE6 | XPGDWT-B1-0000-00KE6 | XPGDWT-H1-0000-00KE6 | |
| | | S2 | 148 | 161 | | | XPGDWT-H1-0000-00JE6 | |
| | | R5 | 139 | 152 | | | XPGDWT-H1-0000-00HE6 | XPGDWT-U1-0000-00HE6 |
| | | R4 | 130 | 142 | | | | XPGDWT-U1-0000-00GE6 |
| F7 | 3200 K | S5 | 172 | 187 | | XPGDWT-B1-0000-00MF7 | | |
| | | S4 | 164 | 179 | XPGDWT-01-0000-00LF7 | XPGDWT-B1-0000-00LF7 | | |
| | | S3 | 156 | 170 | XPGDWT-01-0000-00KF7 | XPGDWT-B1-0000-00KF7 | XPGDWT-H1-0000-00KF7 | |
| | | S2 | 148 | 161 | XPGDWT-01-0000-00JF7 | XPGDWT-B1-0000-00JF7 | XPGDWT-H1-0000-00JF7 | |
| | | R5 | 139 | 152 | | | XPGDWT-H1-0000-00HF7 | |
| | | R4 | 130 | 142 | | | | XPGDWT-U1-0000-00GF7 |
| | | R3 | 122 | 133 | | | | XPGDWT-U1-0000-00FF7 |
| 7E | 3000 K | S5 | 172 | 187 | | XPGDWT-B1-0000-00M7E | | |
| | | S4 | 164 | 179 | | XPGDWT-B1-0000-00L7E | | |
| | | S3 | 156 | 170 | | XPGDWT-B1-0000-00K7E | XPGDWT-H1-0000-00K7E | |
| | | S2 | 148 | 161 | | XPGDWT-B1-0000-00J7E | XPGDWT-H1-0000-00J7E | |
| | | R5 | 139 | 152 | | | XPGDWT-H1-0000-00H7E | |
| | | R4 | 130 | 142 | | | | XPGDWT-U1-0000-00G7E |
| | | R3 | 122 | 133 | | | | XPGDWT-U1-0000-00F7E |
| 7G | 3000 K | R4 | 130 | 142 | | | | XPGDWT-U1-0000-00G7G |
| | | R3 | 122 | 133 | | | | XPGDWT-U1-0000-00F7G |
| E7 | 3000 K | S5 | 172 | 187 | | XPGDWT-B1-0000-00ME7 | | |
| | | S4 | 164 | 179 | XPGDWT-01-0000-00LE7 | XPGDWT-B1-0000-00LE7 | | |
| | | S3 | 156 | 170 | XPGDWT-01-0000-00KE7 | XPGDWT-B1-0000-00KE7 | XPGDWT-H1-0000-00KE7 | |
| | | S2 | 148 | 161 | XPGDWT-01-0000-00JE7 | XPGDWT-B1-0000-00JE7 | XPGDWT-H1-0000-00JE7 | |
| | | R5 | 139 | 152 | | | XPGDWT-H1-0000-00HE7 | |
| | | R4 | 130 | 142 | | | | XPGDWT-U1-0000-00GE7 |
| | | R3 | 122 | 133 | | | | XPGDWT-U1-0000-00FE7 |

Notes

- Cree LED maintains a tolerance of ±7% on flux and power measurements, ±0.005 on chromaticity (CCx, CCy) measurements and a tolerance of ±2 on CRI measurements. See the Measurements section (page 39).
- XLamp XP-G3 LED order codes specify only a minimum flux bin and not a maximum. Cree LED may ship reels in flux bins higher than the minimum specified by the order code without advance notice. Shipments will always adhere to the chromaticity bin restrictions specified by the order code.
- * Flux values @ 25 °C are calculated and for reference only.

ORDER CODES SUGGESTED FOR NEW DESIGNS - WHITE (STANDARD) - T_j = 85 °C (CONTINUED)

| Chromaticity | | Minimum Luminous Flux (lm) @ 350 mA | | | Order Codes | | | |
|--------------|--------|-------------------------------------|-------------------|--------------------|----------------------|----------------------|----------------------|----------------------|
| Kit | CCT | Code | Flux (lm) @ 85 °C | Flux (lm) @ 25 °C* | 70 CRI Typical | 70 CRI Minimum | 80 CRI Minimum | 90 CRI Minimum |
| F8 | 2850 K | S2 | 148 | 161 | | | XPGDWT-H1-0000-00JF8 | |
| | | R5 | 139 | 152 | | | XPGDWT-H1-0000-00HF8 | |
| | | R4 | 130 | 142 | | | XPGDWT-H1-0000-00GF8 | |
| | | R3 | 122 | 133 | | | | XPGDWT-U1-0000-00FF8 |
| | | R2 | 114 | 124 | | | | XPGDWT-U1-0000-00EF8 |
| 8E | 2700 K | S4 | 164 | 179 | | XPGDWT-B1-0000-00L8E | | |
| | | S3 | 156 | 170 | | XPGDWT-B1-0000-00K8E | | |
| | | S2 | 148 | 161 | | XPGDWT-B1-0000-00J8E | XPGDWT-H1-0000-00J8E | |
| | | R5 | 139 | 152 | | | XPGDWT-H1-0000-00H8E | |
| | | R4 | 130 | 142 | | | XPGDWT-H1-0000-00G8E | |
| | | R3 | 122 | 133 | | | | XPGDWT-U1-0000-00F8E |
| | | R2 | 114 | 124 | | | | XPGDWT-U1-0000-00E8E |
| 8G | 2700 K | R3 | 122 | 133 | | | | XPGDWT-U1-0000-00F8G |
| | | R2 | 114 | 124 | | | | XPGDWT-U1-0000-00E8G |
| E8 | 2700 K | S4 | 164 | 179 | | XPGDWT-B1-0000-00LE8 | | |
| | | S3 | 156 | 170 | | XPGDWT-B1-0000-00KE8 | | |
| | | S2 | 148 | 161 | | XPGDWT-B1-0000-00JE8 | XPGDWT-H1-0000-00JE8 | |
| | | R5 | 139 | 152 | | | XPGDWT-H1-0000-00HE8 | |
| | | R4 | 130 | 142 | | | XPGDWT-H1-0000-00GE8 | |
| | | R3 | 122 | 133 | | | | XPGDWT-U1-0000-00FE8 |
| | | R2 | 114 | 124 | | | | XPGDWT-U1-0000-00EE8 |
| EA | 2200 K | R5 | 139 | 152 | | XPGDWT-B1-0000-00HEA | | |
| | | R4 | 130 | 142 | | XPGDWT-B1-0000-00GEA | | |
| BE | 1800 K | R3 | 122 | 133 | XPGDWT-01-0000-00FBE | | | |
| | | R2 | 114 | 124 | XPGDWT-01-0000-00EBE | | | |

Notes

- Cree LED maintains a tolerance of ±7% on flux and power measurements, ±0.005 on chromaticity (CCx, CCy) measurements and a tolerance of ±2 on CRI measurements. See the Measurements section (page 39).
- XLamp XP-G3 LED order codes specify only a minimum flux bin and not a maximum. Cree LED may ship reels in flux bins higher than the minimum specified by the order code without advance notice. Shipments will always adhere to the chromaticity bin restrictions specified by the order code.
- * Flux values @ 25 °C are calculated and for reference only.

ORDER CODES SUGGESTED FOR NEW DESIGNS - WHITE (S LINE) - T_J = 85 °C

The following table provides order codes for XLamp XP-G3 White (S Line) LEDs. For a complete description of the order code nomenclature, please see the Bin and Order Code Formats section (page 37). For definitions of the chromaticity kits, please see the Standard Chromaticity Kits section (page 36).

| Chromaticity | | Minimum Luminous Flux (lm) @ 350 mA | | | Order Codes |
|--------------|--------|-------------------------------------|-------------------|--------------------|----------------------|
| Kit | CCT | Code | Flux (lm) @ 85 °C | Flux (lm) @ 25 °C* | 70 CRI Minimum |
| E1 | 6500 K | S6 | 180 | 196 | XPGDWT-BS-0000-00NE1 |
| | | S5 | 172 | 187 | XPGDWT-BS-0000-00ME1 |
| | | S4 | 164 | 179 | XPGDWT-BS-0000-00LE1 |
| DV | 6000 K | S6 | 180 | 196 | XPGDWT-BS-0000-00NDV |
| | | S5 | 172 | 187 | XPGDWT-BS-0000-00MDV |
| | | S4 | 164 | 179 | XPGDWT-BS-0000-00LDV |
| 50 | 6000 K | S6 | 180 | 196 | XPGDWT-BS-0000-00N50 |
| | | S5 | 172 | 187 | XPGDWT-BS-0000-00M50 |
| | | S4 | 164 | 179 | XPGDWT-BS-0000-00L50 |
| E2 | 5700 K | S7 | 188 | 205 | XPGDWT-BS-0000-00PE2 |
| | | S6 | 180 | 196 | XPGDWT-BS-0000-00NE2 |
| | | S5 | 172 | 187 | XPGDWT-BS-0000-00ME2 |
| | | S4 | 164 | 179 | XPGDWT-BS-0000-00LE2 |
| 2E | 5700 K | S7 | 188 | 205 | XPGDWT-BS-0000-00P2E |
| | | S6 | 180 | 196 | XPGDWT-BS-0000-00N2E |
| | | S5 | 172 | 187 | XPGDWT-BS-0000-00M2E |
| | | S4 | 164 | 179 | XPGDWT-BS-0000-00L2E |
| 3E | 5000 K | S7 | 188 | 205 | XPGDWT-BS-0000-00P3E |
| | | S6 | 180 | 196 | XPGDWT-BS-0000-00N3E |
| | | S5 | 172 | 187 | XPGDWT-BS-0000-00M3E |
| | | S4 | 164 | 179 | XPGDWT-BS-0000-00L3E |
| E3 | 5000 K | S7 | 188 | 205 | XPGDWT-BS-0000-00PE3 |
| | | S6 | 180 | 196 | XPGDWT-BS-0000-00NE3 |
| | | S5 | 172 | 187 | XPGDWT-BS-0000-00ME3 |
| | | S4 | 164 | 179 | XPGDWT-BS-0000-00LE3 |

Notes

- Cree LED maintains a tolerance of ±7% on flux and power measurements, ±0.005 on chromaticity (CCx, CCy) measurements and a tolerance of ±2 on CRI measurements. See the Measurements section (page 39).
- XLamp XP-G3 LED order codes specify only a minimum flux bin and not a maximum. Cree LED may ship reels in flux bins higher than the minimum specified by the order code without advance notice. Shipments will always adhere to the chromaticity bin restrictions specified by the order code.
- * Flux values @ 25 °C are calculated and for reference only.

ORDER CODES SUGGESTED FOR NEW DESIGNS - WHITE (S LINE) - T_J = 85 °C (CONTINUED)

| Chromaticity | | Minimum Luminous Flux (lm) @ 350 mA | | | Order Codes |
|--------------|--------|-------------------------------------|-------------------|--------------------|----------------------|
| Kit | CCT | Code | Flux (lm) @ 85 °C | Flux (lm) @ 25 °C* | 70 CRI Minimum |
| 4E | 4500 K | S7 | 188 | 205 | XPGDWT-BS-0000-00P4E |
| | | S6 | 180 | 196 | XPGDWT-BS-0000-00N4E |
| | | S5 | 172 | 187 | XPGDWT-BS-0000-00M4E |
| | | S4 | 164 | 179 | XPGDWT-BS-0000-00L4E |
| E4 | 4500 K | S7 | 188 | 205 | XPGDWT-BS-0000-00PE4 |
| | | S6 | 180 | 196 | XPGDWT-BS-0000-00NE4 |
| | | S5 | 172 | 187 | XPGDWT-BS-0000-00ME4 |
| | | S4 | 164 | 179 | XPGDWT-BS-0000-00LE4 |
| 5E | 4000 K | S7 | 188 | 205 | XPGDWT-BS-0000-00P5E |
| | | S6 | 180 | 196 | XPGDWT-BS-0000-00N5E |
| | | S5 | 172 | 187 | XPGDWT-BS-0000-00M5E |
| | | S4 | 164 | 179 | XPGDWT-BS-0000-00L5E |
| E5 | 4000 K | S7 | 188 | 205 | XPGDWT-BS-0000-00PE5 |
| | | S6 | 180 | 196 | XPGDWT-BS-0000-00NE5 |
| | | S5 | 172 | 187 | XPGDWT-BS-0000-00ME5 |
| | | S4 | 164 | 179 | XPGDWT-BS-0000-00LE5 |
| 6E | 3500 K | S6 | 180 | 196 | XPGDWT-BS-0000-00N6E |
| | | S5 | 172 | 187 | XPGDWT-BS-0000-00M6E |
| | | S4 | 164 | 179 | XPGDWT-BS-0000-00L6E |
| E6 | 3500 K | S6 | 180 | 196 | XPGDWT-BS-0000-00NE6 |
| | | S5 | 172 | 187 | XPGDWT-BS-0000-00ME6 |
| | | S4 | 164 | 179 | XPGDWT-BS-0000-00LE6 |
| F7 | 3200K | S6 | 180 | 196 | XPGDWT-BS-0000-00NF7 |
| | | S5 | 172 | 187 | XPGDWT-BS-0000-00MF7 |
| | | S4 | 164 | 179 | XPGDWT-BS-0000-00LF7 |
| 7E | 3000 K | S6 | 180 | 196 | XPGDWT-BS-0000-00N7E |
| | | S5 | 172 | 187 | XPGDWT-BS-0000-00M7E |
| | | S4 | 164 | 179 | XPGDWT-BS-0000-00L7E |

Notes

- Cree LED maintains a tolerance of ±7% on flux and power measurements, ±0.005 on chromaticity (CCx, CCy) measurements and a tolerance of ±2 on CRI measurements. See the Measurements section (page 39).
- XLamp XP-G3 LED order codes specify only a minimum flux bin and not a maximum. Cree LED may ship reels in flux bins higher than the minimum specified by the order code without advance notice. Shipments will always adhere to the chromaticity bin restrictions specified by the order code.
- * Flux values @ 25 °C are calculated and for reference only.

ORDER CODES SUGGESTED FOR NEW DESIGNS - WHITE (S LINE) - $T_j = 85\text{ }^\circ\text{C}$ (CONTINUED)

| Chromaticity | | Minimum Luminous Flux (lm) @ 350 mA | | | Order Codes |
|--------------|--------|-------------------------------------|-------------------|--------------------|----------------------|
| Kit | CCT | Code | Flux (lm) @ 85 °C | Flux (lm) @ 25 °C* | 70 CRI Minimum |
| E7 | 3000 K | S6 | 180 | 196 | XPGDWT-BS-0000-00NE7 |
| | | S5 | 172 | 187 | XPGDWT-BS-0000-00ME7 |
| | | S4 | 164 | 179 | XPGDWT-BS-0000-00LE7 |

Notes

- Cree LED maintains a tolerance of $\pm 7\%$ on flux and power measurements, ± 0.005 on chromaticity (CCx, CCy) measurements and a tolerance of ± 2 on CRI measurements. See the Measurements section (page 39).
- XLamp XP-G3 LED order codes specify only a minimum flux bin and not a maximum. Cree LED may ship reels in flux bins higher than the minimum specified by the order code without advance notice. Shipments will always adhere to the chromaticity bin restrictions specified by the order code.
- * Flux values @ 25 °C are calculated and for reference only.

FLUX CHARACTERISTICS - COLOR (STANDARD) - $T_j = 25\text{ }^\circ\text{C}$

The following tables provide the order codes for XLamp XP-G3 color (Standard) LEDs. For a complete description of the order code nomenclature, please see the Bin and Order Code Formats section (page 37).

| Color | PWL Kit Code | Peak Wavelength Range | | | | Typical Dominant Wavelength (nm) @ 350 mA, $T_j = 25\text{ }^\circ\text{C}$ | Minimum Radiant Flux (mW) @ 350 mA, | | Calculated Minimum PPF ($\mu\text{mol/s}$) @ 350 mA, $25\text{ }^\circ\text{C}$ | Order Code |
|-----------------------|--------------|-----------------------|----------|---------|----------|--|--|-----------------------------------|--|----------------------|
| | | Minimum | | Maximum | | | Code | Flux (mW) @25 $^\circ\text{C}$ | | |
| | | Group | PWL (nm) | Group | PWL (nm) | | | | | |
| Royal Blue (Standard) | 01 | H26 | 440 | H47 | 455 | 451 | F2 | 680 | 2.58 | XPGDRY-L1-0000-00501 |
| | | | | | | | F4 | 730 | 2.77 | XPGDRY-L1-0000-00601 |

| Color | PWL Kit Code | Peak Wavelength Range | | | | Typical Dominant Wavelength (nm) @ 350 mA, $T_j = 25\text{ }^\circ\text{C}$ | Minimum Radiant Flux (mW) @ 350 mA, | | Calculated Minimum PPF ($\mu\text{mol/s}$) @ 350 mA, $25\text{ }^\circ\text{C}$ | Order Code |
|----------------------|--------------|-----------------------|----------|---------|----------|--|--|-----------------------------------|--|----------------------|
| | | Minimum | | Maximum | | | Code | Flux (mW) @25 $^\circ\text{C}$ | | |
| | | Group | PWL (nm) | Group | PWL (nm) | | | | | |
| Photo Red (Standard) | 01 | P2 | 650 | P5 | 670 | 645 | 31 | 475 | 2.58 | XPGDPR-L1-0000-00E01 |
| | | | | | | | 32 | 500 | 2.72 | XPGDPR-L1-0000-00F01 |

Notes

- Cree LED maintains a tolerance of $\pm 7\%$ on flux and power measurements, ± 0.005 on chromaticity (CCx, CCy) measurements and a tolerance of ± 2 on CRI measurements. See the Measurements section (page 39).
- XLamp XP-G3 LED order codes specify only a minimum flux bin and not a maximum. Cree LED may ship reels in flux bins higher than the minimum specified by the order code without advance notice. Shipments will always adhere to the chromaticity bin restrictions specified by the order code.
- Dominant wavelengths are calculated based on peak wavelength specifications and are for reference only.
- Calculated Photosynthetic Photon Flux (PPF) values are for reference only.

FLUX CHARACTERISTICS - COLOR (S LINE) - $T_j = 25\text{ }^\circ\text{C}$

The following tables provide the order codes for XLamp XP-G3 color (S Line) LEDs. For a complete description of the order code nomenclature, please see the Bin and Order Code Formats section (page 37).

| Color | PWL Kit Code | Peak Wavelength Range | | | | Typical Dominant Wavelength (nm) @ 350 mA, $T_j=25\text{ }^\circ\text{C}$ | Minimum Radiant Flux (mW) @ 350 mA, | | Calculated Minimum PPF ($\mu\text{mol/s}$) @ 350 mA, $25\text{ }^\circ\text{C}$ | Order Code |
|---------------------|--------------|-----------------------|----------|---------|----------|---|-------------------------------------|--------------------------------|---|----------------------|
| | | Minimum | | Maximum | | | Code | Flux (mW) @25 $^\circ\text{C}$ | | |
| | | Group | PWL (nm) | Group | PWL (nm) | | | | | |
| Royal Blue (S Line) | 01 | H26 | 440 | H47 | 455 | 451 | F2 | 680 | 2.58 | XPGDRY-LS-0000-00501 |
| | | | | | | 451 | F4 | 730 | 2.77 | XPGDRY-LS-0000-00601 |

| Color | PWL Kit Code | Peak Wavelength Range | | | | Typical Dominant Wavelength (nm) @ 350 mA, $T_j=25\text{ }^\circ\text{C}$ | Minimum Radiant Flux (mW) @ 350 mA, | | Calculated Minimum PPF ($\mu\text{mol/s}$) @ 350 mA, $25\text{ }^\circ\text{C}$ | Order Code |
|--------------------|--------------|-----------------------|----------|---------|----------|---|-------------------------------------|--------------------------------|---|----------------------|
| | | Minimum | | Maximum | | | Code | Flux (mW) @25 $^\circ\text{C}$ | | |
| | | Group | PWL (nm) | Group | PWL (nm) | | | | | |
| Photo Red (S Line) | 01 | P2 | 650 | P5 | 670 | 645 | 33 | 525 | 2.85 | XPGDPR-LS-0000-00G01 |
| | | | | | | 645 | 34 | 550 | 2.98 | XPGDPR-LS-0000-00H01 |
| | | | | | | 645 | 35 | 575 | 3.11 | XPGDPR-LS-0000-00J01 |

FLUX CHARACTERISTICS - BROADCAST ORDER CODES AND BINS ($T_j = 85\text{ }^\circ\text{C}$)

The following table provides order codes for XLamp XP-G3 Broadcast LEDs. For a complete description of the order code nomenclature, please see the Bin and Order Code Formats section (page 37). For definitions of the chromaticity kits, please see the Standard Chromaticity Kits section (page 36).

| Chromaticity | | Minimum Luminous Flux (lm) @ 350 mA | | | Order Codes | |
|--------------|--------|-------------------------------------|---------------------------------|-----------------------------------|-----------------------------------|-----------------------------------|
| Kit | CCT | Flux Bin | Flux (lm) @ 85 $^\circ\text{C}$ | Flux (lm) @ 25 $^\circ\text{C}^*$ | 90 CRI Minimum 90 TLCI Minimum | 95 CRI Minimum 95 TLCI Minimum |
| E2 | 5700 K | R5 | 139 | 152 | XPGDWT-U1-B001-A0HE2 | XPGDWT-Z1-B001-A0GE2 |
| | | R4 | 130 | 142 | | |

Notes

- Cree LED maintains a tolerance of $\pm 7\%$ on flux and power measurements, ± 0.005 on chromaticity (CCx, CCy) measurements and a tolerance of ± 2 on CRI measurements. See the Measurements section (page 39).
- XLamp XP-G3 LED order codes specify only a minimum flux bin and not a maximum. Cree LED may ship reels in flux bins higher than the minimum specified by the order code without advance notice. Shipments will always adhere to the chromaticity bin restrictions specified by the order code.
- * Flux values @ 25 $^\circ\text{C}$ are calculated and for reference only.

RELATIVE SPECTRAL POWER DISTRIBUTION - WHITE (STANDARD)

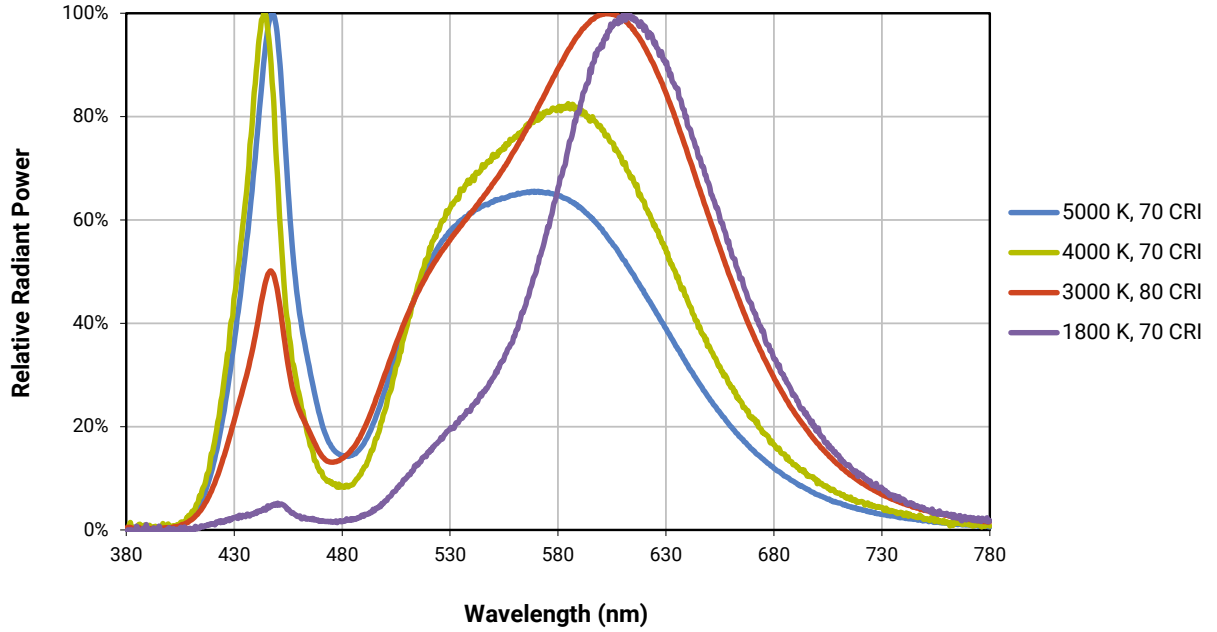

RELATIVE SPECTRAL POWER DISTRIBUTION - WHITE (S LINE)

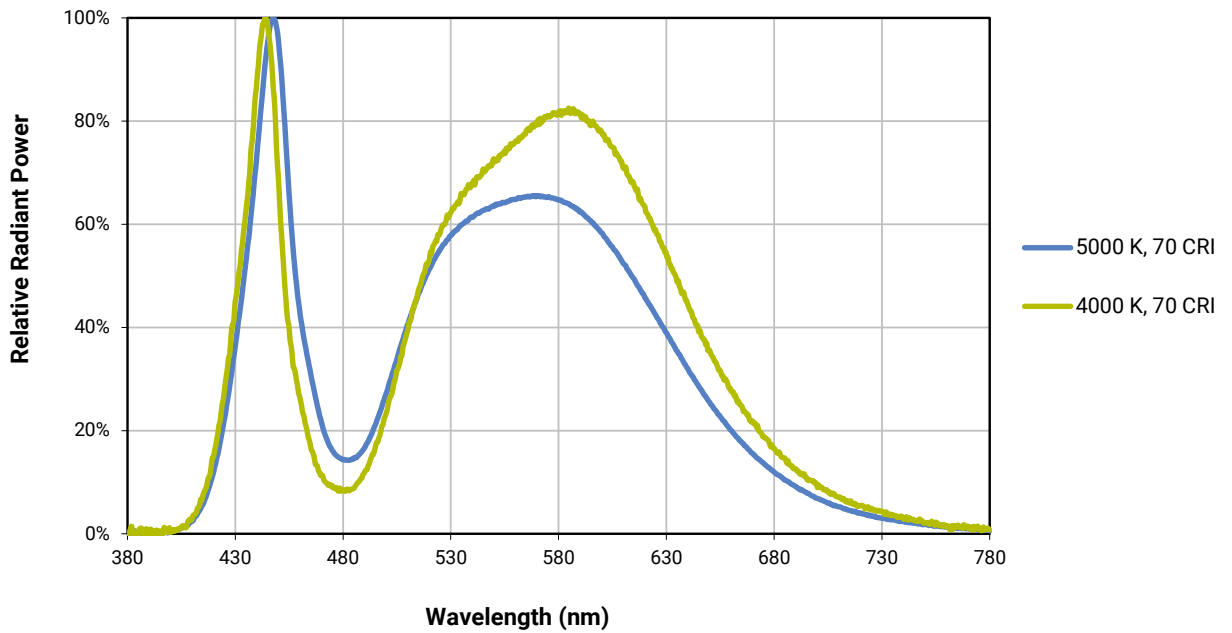

RELATIVE SPECTRAL POWER DISTRIBUTION - COLOR

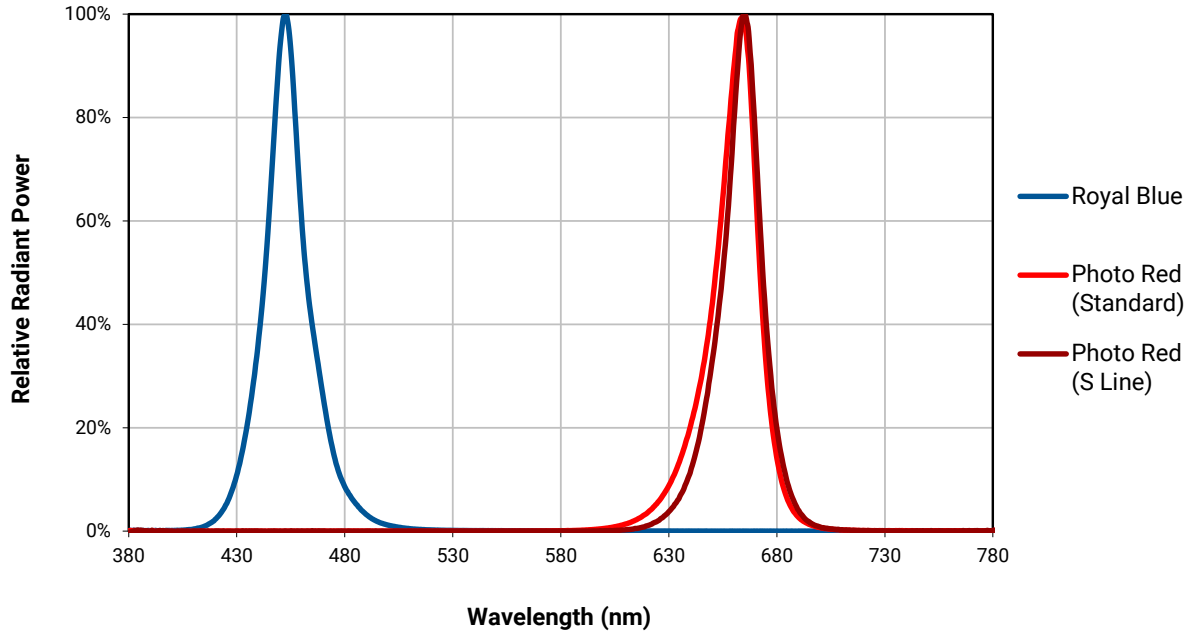

RELATIVE FLUX VS. JUNCTION TEMPERATURE - WHITE (STANDARD) - $I_f = 350$ mA

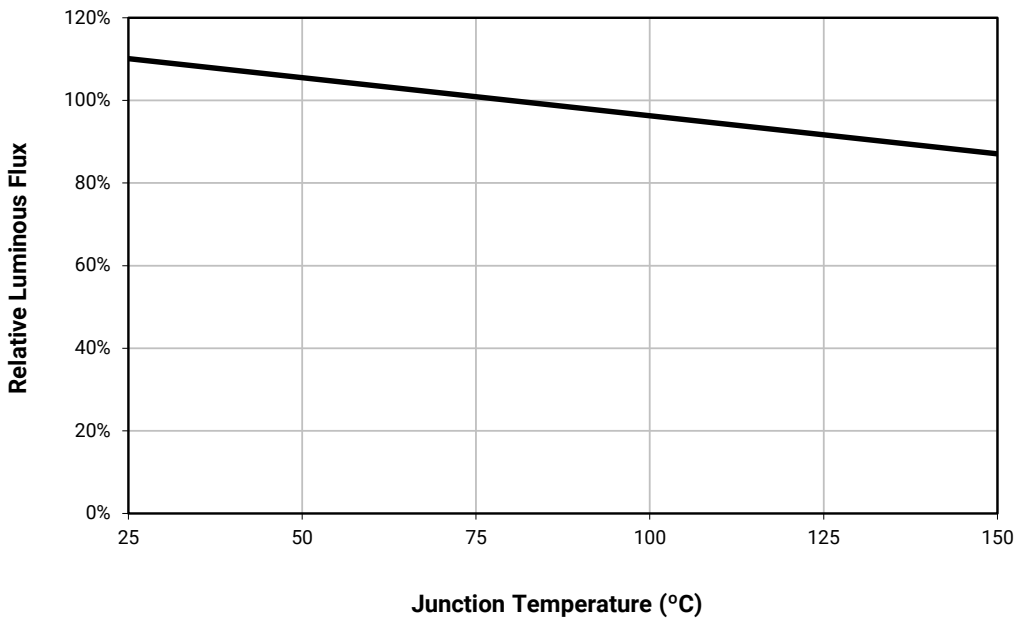

RELATIVE FLUX VS. JUNCTION TEMPERATURE - WHITE (S LINE) - $I_F = 350 \text{ mA}$

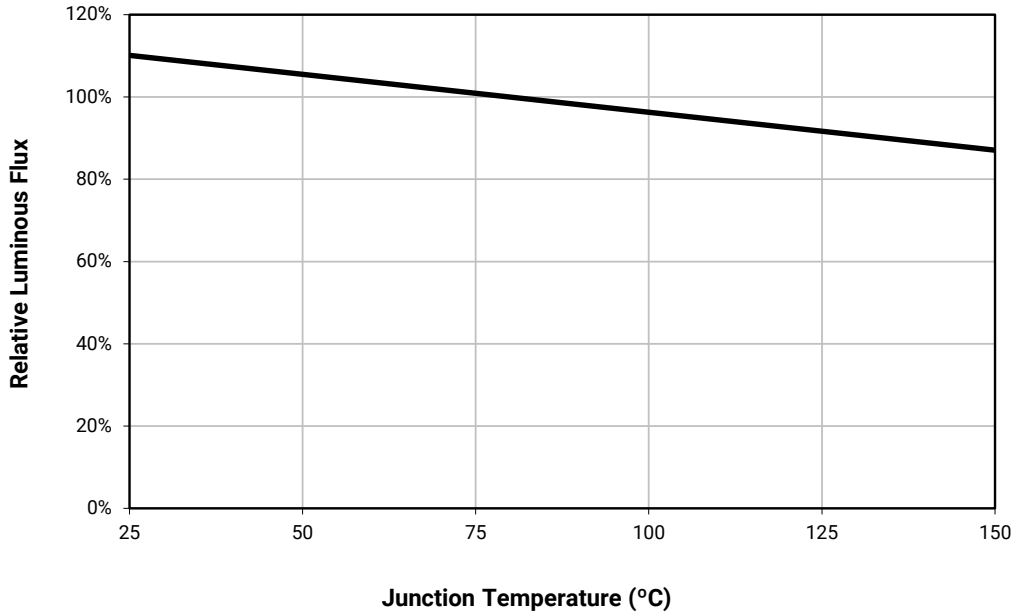

RELATIVE FLUX VS. JUNCTION TEMPERATURE - COLOR - $I_F = 350 \text{ mA}$

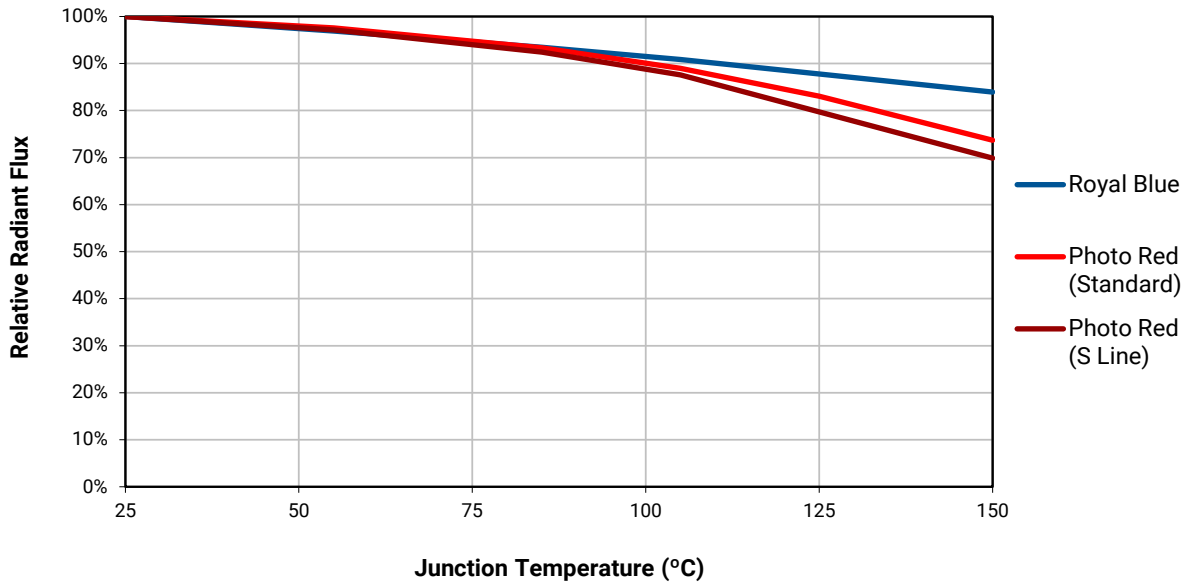

ELECTRICAL CHARACTERISTICS - WHITE (STANDARD) - $T_j = 85\text{ }^\circ\text{C}$

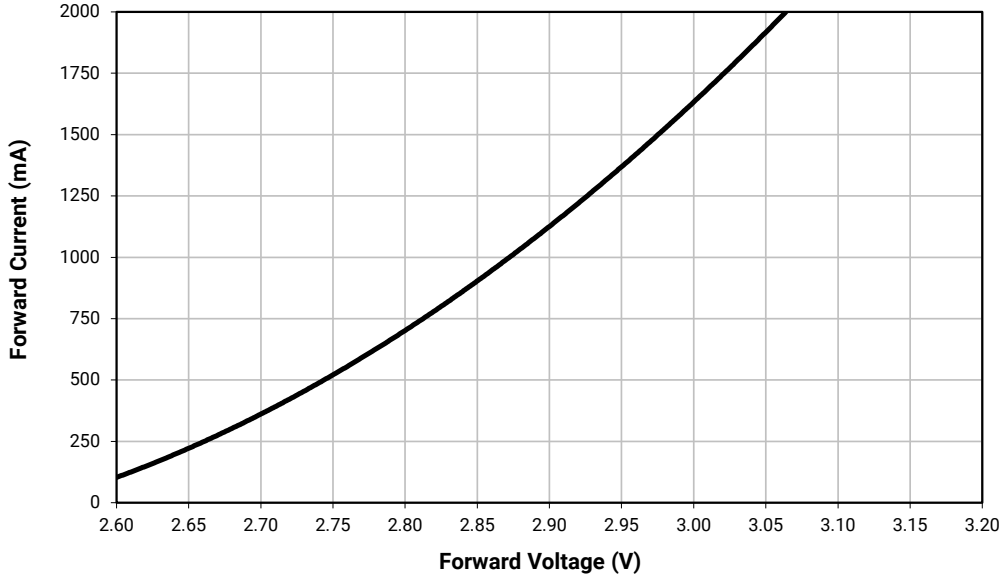

ELECTRICAL CHARACTERISTICS - WHITE (S LINE) - $T_j = 85\text{ }^\circ\text{C}$

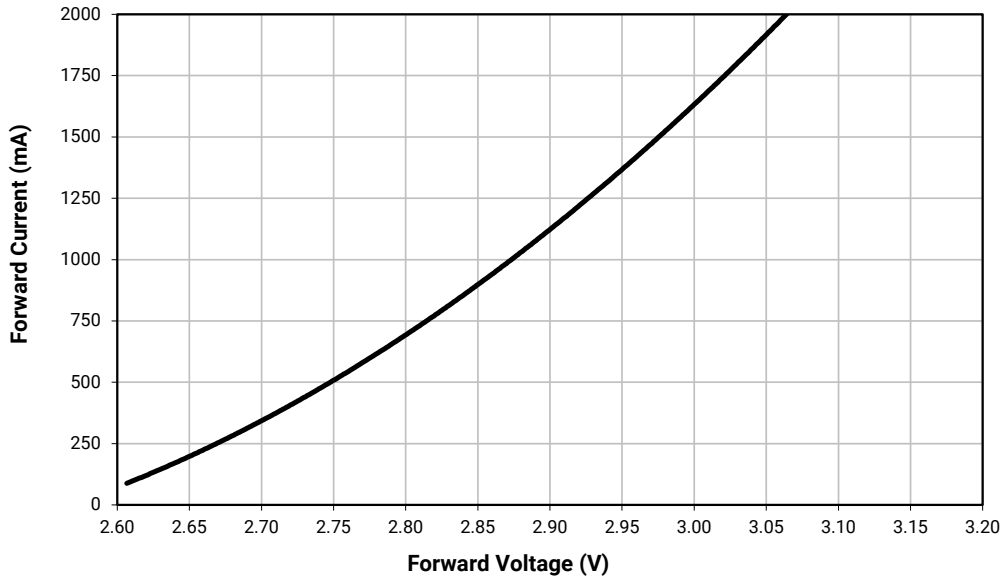

ELECTRICAL CHARACTERISTICS - COLOR ($T_j = 25\text{ }^\circ\text{C}$)

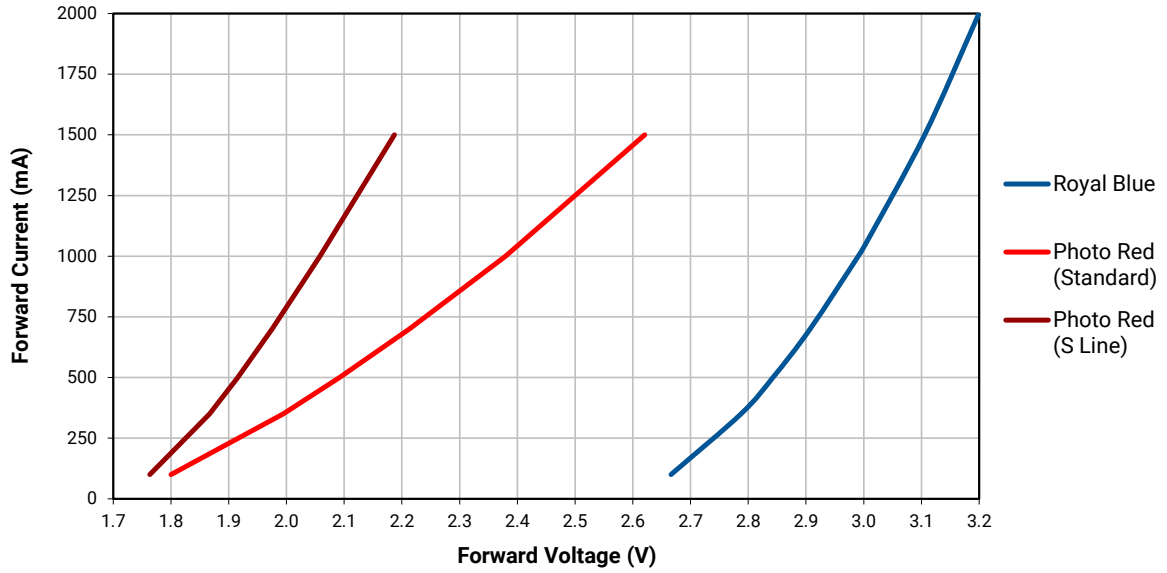

RELATIVE LUMINOUS FLUX VS. CURRENT - WHITE (STANDARD) - $T_j = 85\text{ }^\circ\text{C}$

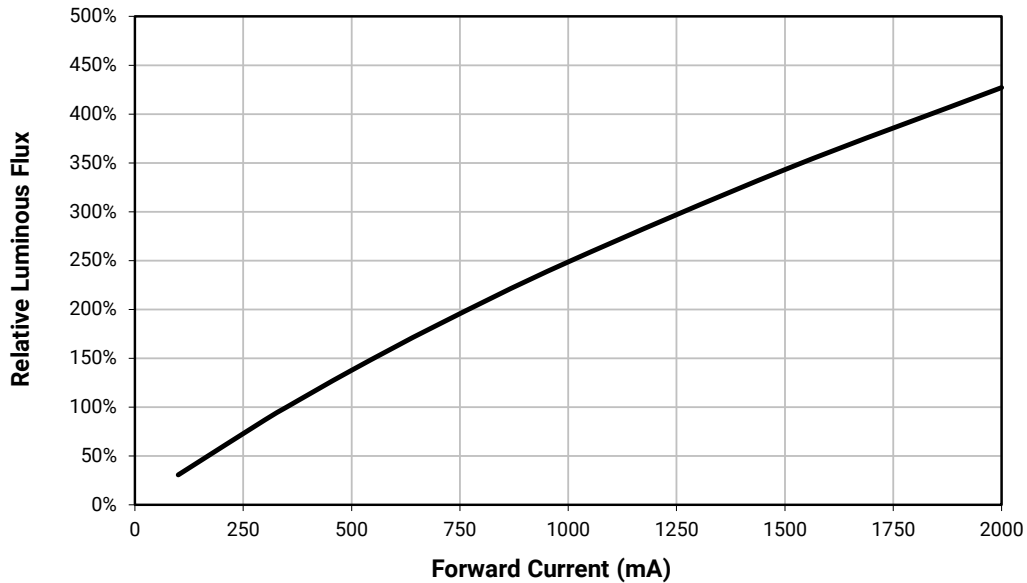

RELATIVE LUMINOUS FLUX VS. CURRENT - WHITE (S LINE) - $T_j = 85\text{ }^\circ\text{C}$

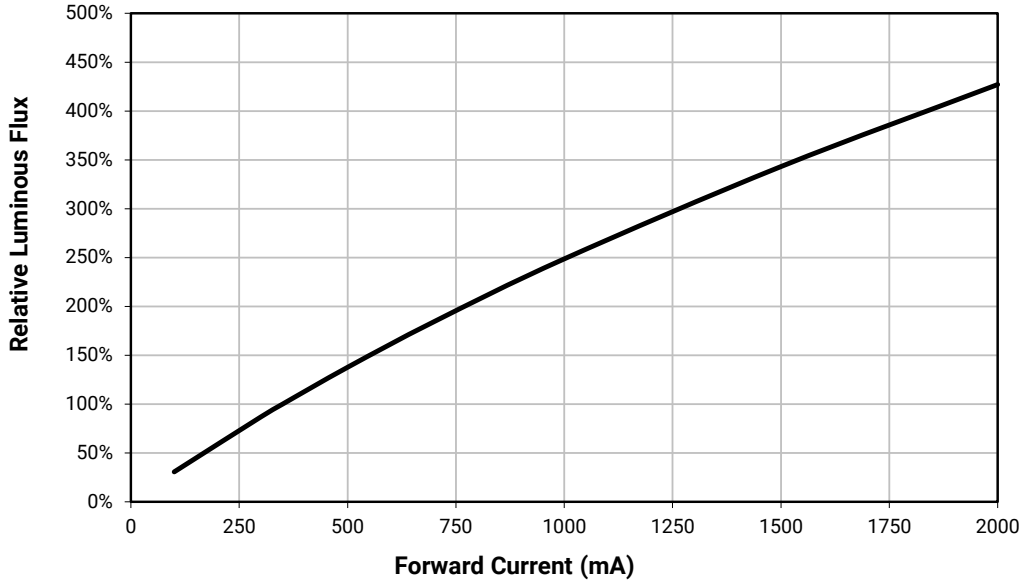

RELATIVE RADIANT FLUX VS. CURRENT - COLOR ($T_j = 25\text{ }^\circ\text{C}$)

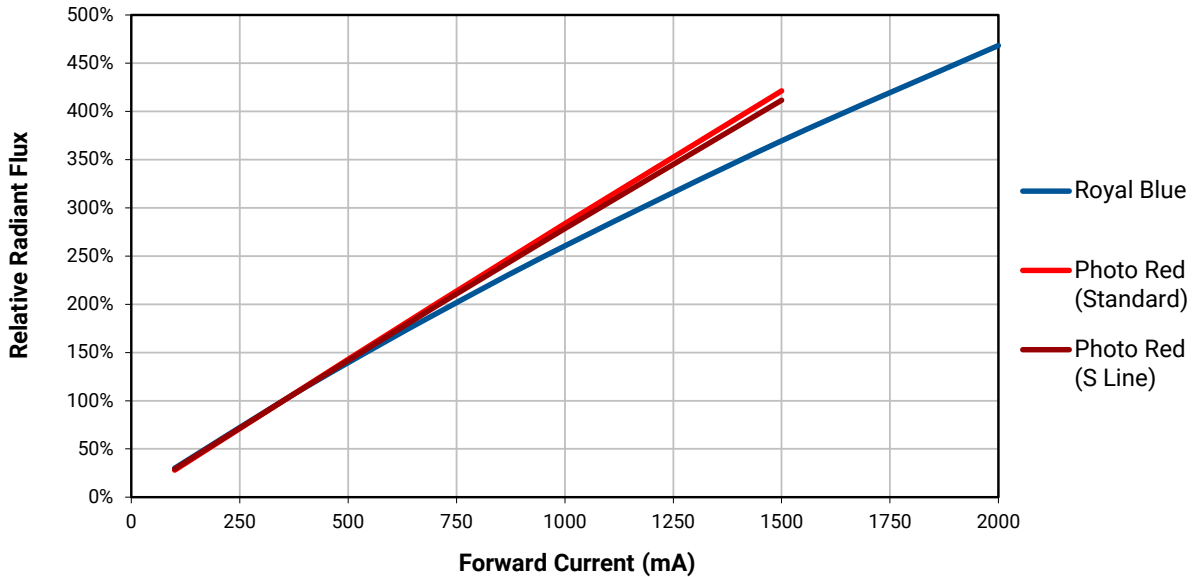

RELATIVE CHROMATICITY VS. CURRENT AND TEMPERATURE

Data shown is representative of typical XP-G3 70 CRI performance.

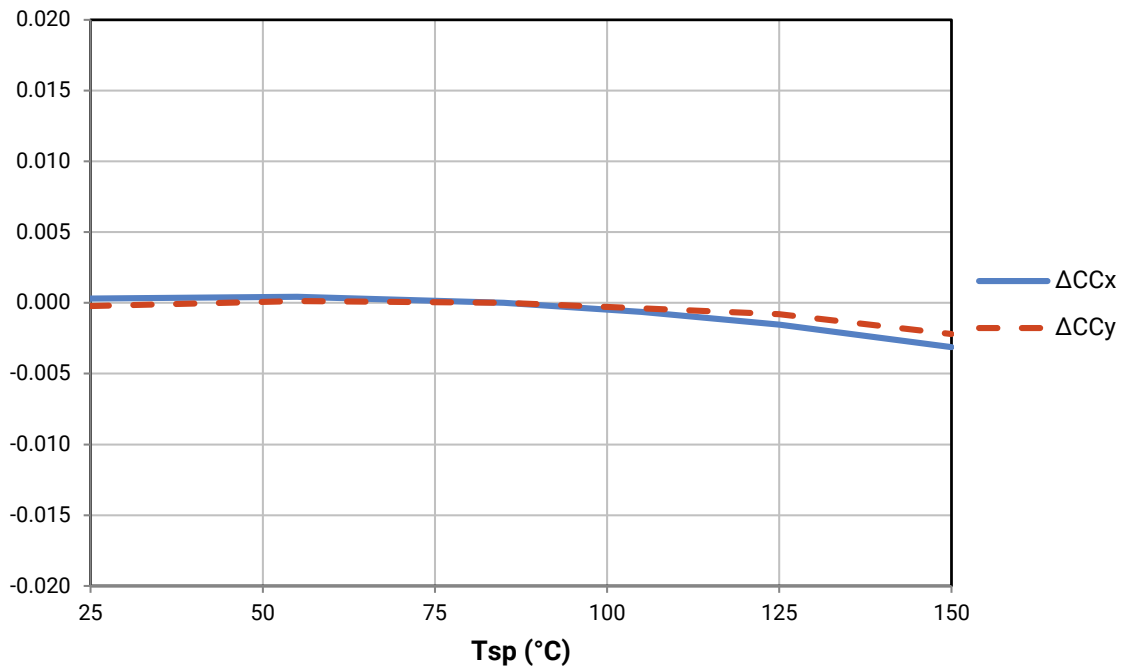
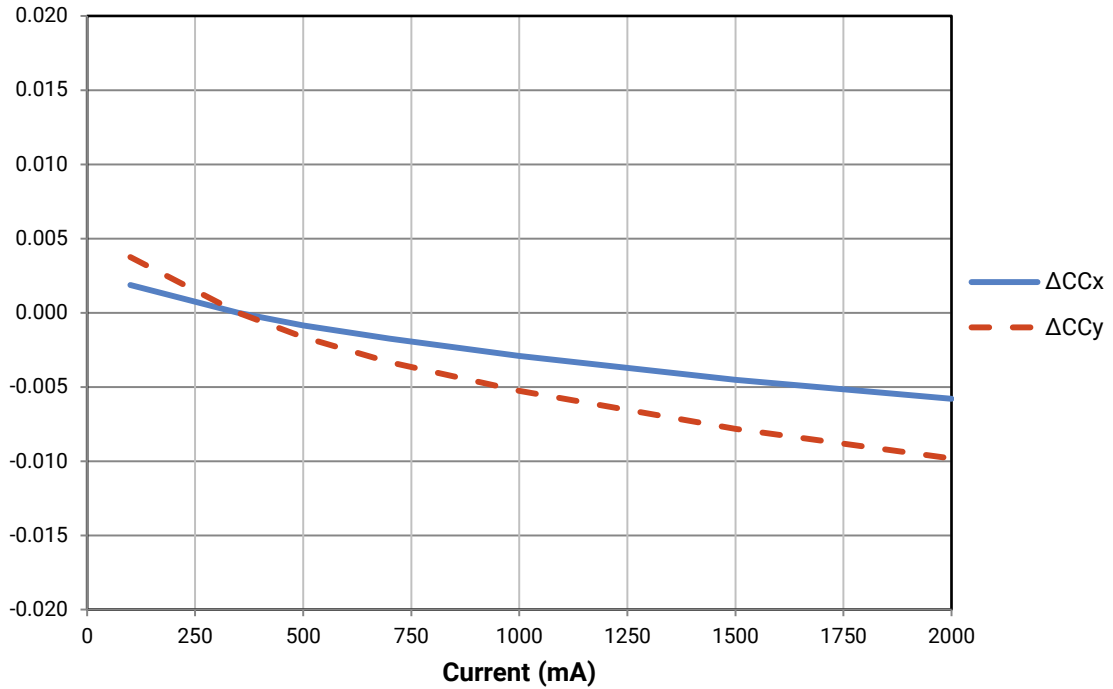

TYPICAL SPATIAL DISTRIBUTION - WHITE (STANDARD)

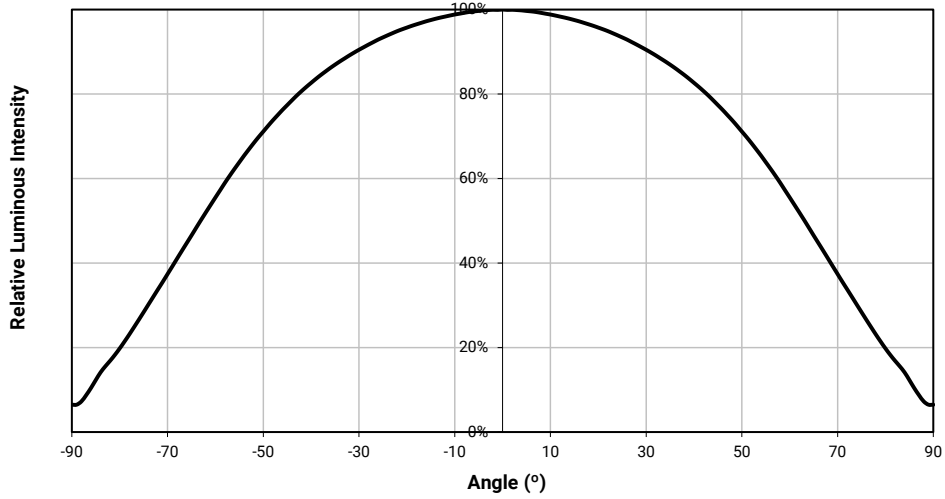

TYPICAL SPATIAL DISTRIBUTION - WHITE (S LINE)

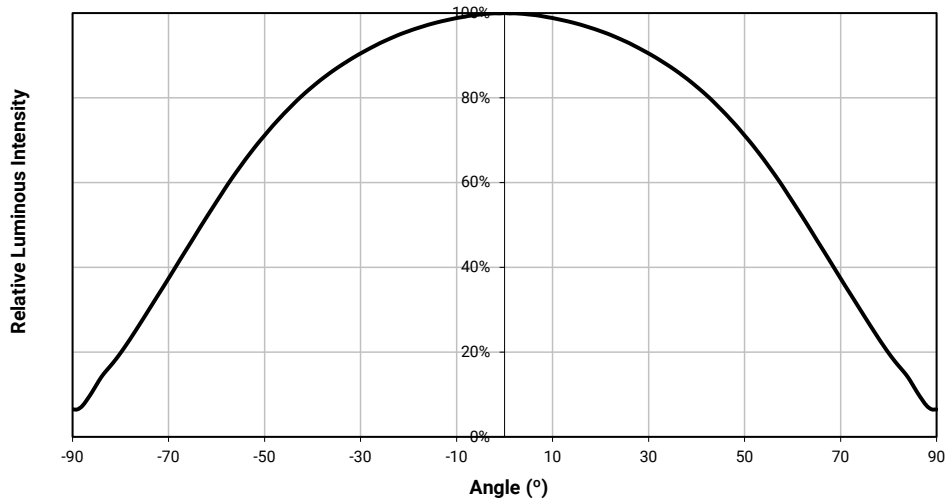

TYPICAL SPATIAL DISTRIBUTION - COLOR

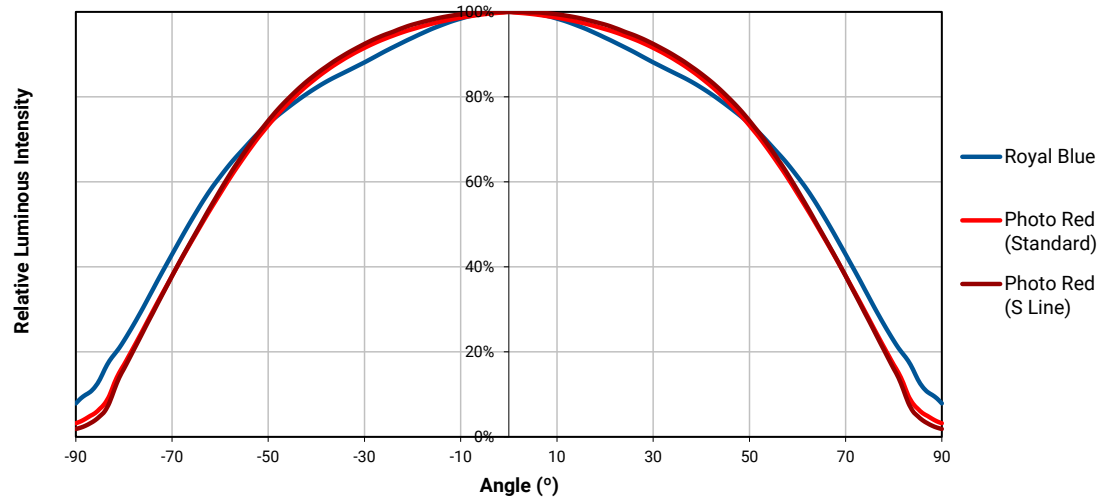

THERMAL DESIGN

The maximum forward current is determined by the thermal resistance between the LED junction and ambient. It is crucial for the end product to be designed in a manner that minimizes the thermal resistance from the solder point to ambient in order to optimize lamp life and optical characteristics.

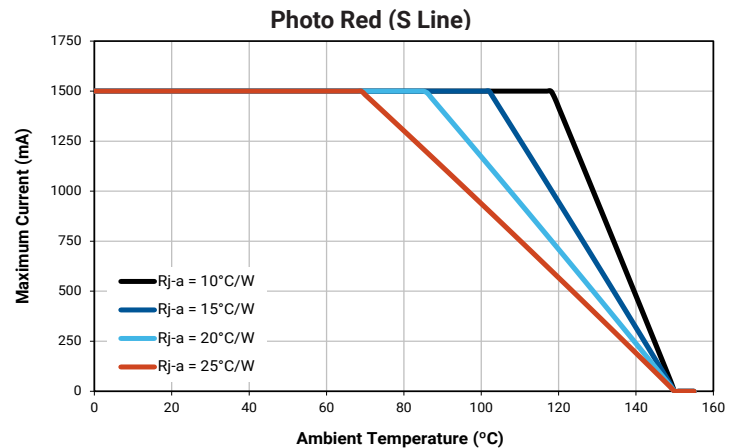
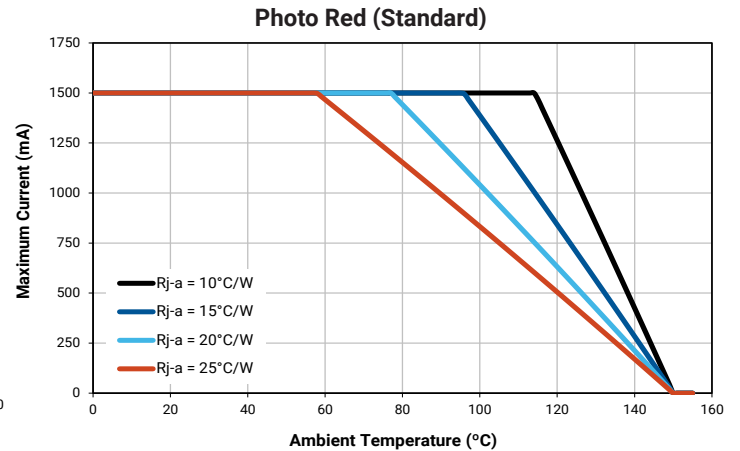
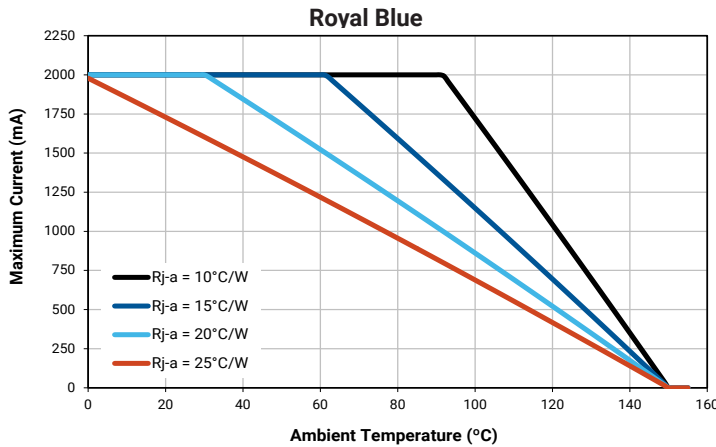
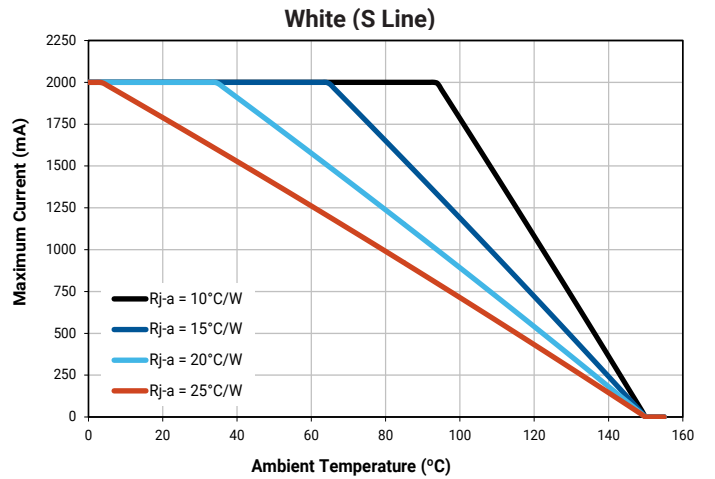
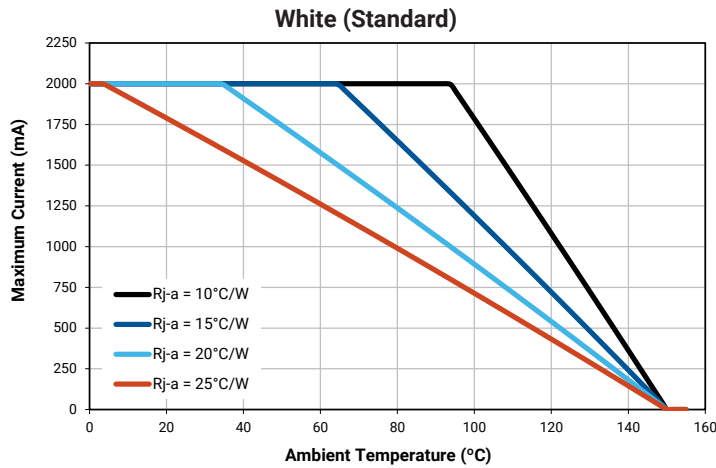

PERFORMANCE GROUPS - LUMINOUS FLUX

XLamp XP-G3 White LEDs are tested for luminous flux and placed into one of the following luminous-flux groups.

| Group Code | Minimum Luminous Flux (lm) @ 350 mA | Maximum Luminous Flux (lm) @ 350 mA |
|------------|--|--|
| Q4 | 100 | 107 |
| Q5 | 107 | 114 |
| R2 | 114 | 122 |
| R3 | 122 | 130 |
| R4 | 130 | 139 |
| R5 | 139 | 148 |
| S2 | 148 | 156 |
| S3 | 156 | 164 |
| S4 | 164 | 172 |
| S5 | 172 | 180 |
| S6 | 180 | 188 |
| S7 | 188 | 196 |
| S8 | 196 | 204 |

PERFORMANCE GROUPS - RADIANT FLUX ($T_j = 25\text{ }^\circ\text{C}$)

XLamp XP-G3 Royal Blue LEDs are tested for radiant flux and placed into one of the following bins.

| Group Code | Minimum Radiant Flux (mW) | Maximum Radiant Flux (mW) | Calculated PPF ($\mu\text{mol/s}$) | |
|------------|---------------------------|---------------------------|--------------------------------------|---------|
| | | | Minimum | Maximum |
| F2 | 680 | 730 | 2.58 | 2.77 |
| F4 | 730 | 780 | 2.77 | 2.96 |

XLamp XP-G3 Photo Red (Standard) LEDs are tested for radiant flux and placed into one of the following bins.

| Group Code | Minimum Radiant Flux (mW) | Maximum Radiant Flux (mW) | Calculated PPF ($\mu\text{mol/s}$) | |
|------------|---------------------------|---------------------------|--------------------------------------|---------|
| | | | Minimum | Maximum |
| 31 | 475 | 500 | 2.58 | 2.72 |
| 32 | 500 | 525 | 2.72 | 2.85 |

XLamp XP-G3 Photo Red (S Line) LEDs are tested for radiant flux and placed into one of the following bins.

| Group Code | Minimum Radiant Flux (mW) | Maximum Radiant Flux (mW) | Calculated PPF ($\mu\text{mol/s}$) | |
|------------|---------------------------|---------------------------|--------------------------------------|---------|
| | | | Minimum | Maximum |
| 32 | 500 | 525 | 2.72 | 2.85 |
| 33 | 525 | 550 | 2.85 | 2.98 |
| 34 | 550 | 575 | 2.98 | 3.11 |
| 35 | 575 | 600 | 3.11 | 3.26 |

Note

- Calculated PPF values are for reference only.

PERFORMANCE GROUPS - PEAK WAVELENGTH ($T_j = 25\text{ °C}$)

XLamp XP-G3 Royal Blue LEDs are tested for peak wavelength and sorted into one of the PWL bins defined below.

| Group Code | Minimum Peak Wavelength (nm) | Maximum Peak Wavelength (nm) | Typical Dominant Wavelength (nm) |
|------------|------------------------------|------------------------------|----------------------------------|
| H26 | 440.0 | 442.5 | 446.5 |
| H27 | 442.5 | 445.0 | 449.0 |
| H36 | 445.0 | 447.5 | 451.5 |
| H37 | 447.5 | 450.0 | 454.0 |
| H46 | 450.0 | 452.5 | 456.5 |
| H47 | 452.5 | 455.0 | 459.0 |

XLamp XP-G3 Photo Red LEDs are tested for peak wavelength and sorted into one of the PWL bins defined below.

| Group Code | Minimum Peak Wavelength (nm) | Maximum Peak Wavelength (nm) | Typical Dominant Wavelength (nm) |
|------------|------------------------------|------------------------------|----------------------------------|
| P2 | 650 | 655 | 638 |
| P3 | 655 | 660 | 643 |
| P4 | 660 | 665 | 647 |
| P5 | 665 | 670 | 652 |

Note

- Typical dominant wavelength values are calculated and for reference only.

PERFORMANCE GROUPS - FORWARD VOLTAGE

XLamp XP-G3 Photo Red LEDs are tested for forward voltage and sorted into one of the forward voltage bins defined below.

| Forward Voltage Group | Minimum Forward Voltage (V) @ 350 mA | Maximum Forward Voltage (V) @ 350 mA |
|-----------------------|--------------------------------------|--------------------------------------|
| W | 1.8 | 1.9 |
| X | 1.9 | 2.0 |
| Y | 2.0 | 2.1 |
| Z | 2.1 | 2.2 |

PERFORMANCE GROUPS - CHROMATICITY

| Region | x | y | Region | x | y | Region | x | y | Region | x | y |
|--------|--------|--------|--------|--------|--------|--------|--------|--------|--------|--------|--------|
| 0A | 0.2950 | 0.2970 | 0B | 0.2920 | 0.3060 | 0C | 0.2984 | 0.3133 | 0D | 0.2984 | 0.3133 |
| | 0.2920 | 0.3060 | | 0.2895 | 0.3135 | | 0.2962 | 0.3220 | | 0.3048 | 0.3207 |
| | 0.2984 | 0.3133 | | 0.2962 | 0.3220 | | 0.3028 | 0.3304 | | 0.3068 | 0.3113 |
| | 0.3009 | 0.3042 | | 0.2984 | 0.3133 | | 0.3048 | 0.3207 | | 0.3009 | 0.3042 |
| 0R | 0.2980 | 0.2880 | 0S | 0.2895 | 0.3135 | 0T | 0.2962 | 0.3220 | 0U | 0.3037 | 0.2937 |
| | 0.2950 | 0.2970 | | 0.2870 | 0.3210 | | 0.2937 | 0.3312 | | 0.3009 | 0.3042 |
| | 0.3009 | 0.3042 | | 0.2937 | 0.3312 | | 0.3005 | 0.3415 | | 0.3068 | 0.3113 |
| | 0.3037 | 0.2937 | | 0.2962 | 0.3220 | | 0.3028 | 0.3304 | | 0.3093 | 0.2993 |
| 1A | 0.3048 | 0.3207 | 1B | 0.3028 | 0.3304 | 1C | 0.3115 | 0.3391 | 1D | 0.3130 | 0.3290 |
| | 0.3130 | 0.3290 | | 0.3115 | 0.3391 | | 0.3205 | 0.3481 | | 0.3213 | 0.3373 |
| | 0.3144 | 0.3186 | | 0.3130 | 0.3290 | | 0.3213 | 0.3373 | | 0.3221 | 0.3261 |
| | 0.3068 | 0.3113 | | 0.3048 | 0.3207 | | 0.3130 | 0.3290 | | 0.3144 | 0.3186 |
| 1R | 0.3068 | 0.3113 | 1S | 0.3005 | 0.3415 | 1T | 0.3099 | 0.3509 | 1U | 0.3144 | 0.3186 |
| | 0.3144 | 0.3186 | | 0.3099 | 0.3509 | | 0.3196 | 0.3602 | | 0.3221 | 0.3261 |
| | 0.3161 | 0.3059 | | 0.3115 | 0.3391 | | 0.3205 | 0.3481 | | 0.3231 | 0.3120 |
| | 0.3093 | 0.2993 | | 0.3028 | 0.3304 | | 0.3115 | 0.3391 | | 0.3161 | 0.3059 |
| 2A | 0.3215 | 0.3350 | 2B | 0.3207 | 0.3462 | 2C | 0.3290 | 0.3538 | 2D | 0.3290 | 0.3417 |
| | 0.3290 | 0.3417 | | 0.3290 | 0.3538 | | 0.3376 | 0.3616 | | 0.3371 | 0.3490 |
| | 0.3290 | 0.3300 | | 0.3290 | 0.3417 | | 0.3371 | 0.3490 | | 0.3366 | 0.3369 |
| | 0.3222 | 0.3243 | | 0.3215 | 0.3350 | | 0.3290 | 0.3417 | | 0.3290 | 0.3300 |
| 2R | 0.3222 | 0.3243 | 2S | 0.3196 | 0.3602 | 2T | 0.3290 | 0.3690 | 2U | 0.3290 | 0.3300 |
| | 0.3290 | 0.3300 | | 0.3290 | 0.3690 | | 0.3381 | 0.3762 | | 0.3366 | 0.3369 |
| | 0.3290 | 0.3180 | | 0.3290 | 0.3538 | | 0.3376 | 0.3616 | | 0.3361 | 0.3245 |
| | 0.3231 | 0.3120 | | 0.3207 | 0.3462 | | 0.3290 | 0.3538 | | 0.3290 | 0.3180 |
| 3A | 0.3371 | 0.3490 | 3B | 0.3376 | 0.3616 | 3C | 0.3463 | 0.3687 | 3D | 0.3451 | 0.3554 |
| | 0.3451 | 0.3554 | | 0.3463 | 0.3687 | | 0.3551 | 0.3760 | | 0.3533 | 0.3620 |
| | 0.3440 | 0.3427 | | 0.3451 | 0.3554 | | 0.3533 | 0.3620 | | 0.3515 | 0.3487 |
| | 0.3366 | 0.3369 | | 0.3371 | 0.3490 | | 0.3451 | 0.3554 | | 0.3440 | 0.3427 |
| 3R | 0.3366 | 0.3369 | 3S | 0.3381 | 0.3762 | | | | | | |
| | 0.3440 | 0.3428 | | 0.3480 | 0.3840 | | | | | | |
| | 0.3429 | 0.3307 | | 0.3463 | 0.3687 | | | | | | |
| | 0.3361 | 0.3245 | | 0.3376 | 0.3616 | | | | | | |
| 4A | 0.3530 | 0.3597 | 4B | 0.3548 | 0.3736 | 4C | 0.3641 | 0.3804 | 4D | 0.3615 | 0.3659 |
| | 0.3615 | 0.3659 | | 0.3641 | 0.3804 | | 0.3736 | 0.3874 | | 0.3702 | 0.3722 |
| | 0.3590 | 0.3521 | | 0.3615 | 0.3659 | | 0.3702 | 0.3722 | | 0.3670 | 0.3578 |
| | 0.3512 | 0.3465 | | 0.3530 | 0.3597 | | 0.3615 | 0.3659 | | 0.3590 | 0.3521 |

PERFORMANCE GROUPS - CHROMATICITY (CONTINUED)

| Region | x | y | Region | x | y | Region | x | y | Region | x | y |
|--------|--------|--------|--------|--------|--------|--------|--------|--------|--------|--------|--------|
| 5A1 | 0.3670 | 0.3578 | 5A2 | 0.3686 | 0.3649 | 5A3 | 0.3744 | 0.3685 | 5A4 | 0.3726 | 0.3612 |
| | 0.3686 | 0.3649 | | 0.3702 | 0.3722 | | 0.3763 | 0.3760 | | 0.3744 | 0.3685 |
| | 0.3744 | 0.3685 | | 0.3763 | 0.3760 | | 0.3825 | 0.3798 | | 0.3804 | 0.3721 |
| | 0.3726 | 0.3612 | | 0.3744 | 0.3685 | | 0.3804 | 0.3721 | | 0.3783 | 0.3646 |
| 5B1 | 0.3702 | 0.3722 | 5B2 | 0.3719 | 0.3797 | 5B3 | 0.3782 | 0.3837 | 5B4 | 0.3763 | 0.3760 |
| | 0.3719 | 0.3797 | | 0.3736 | 0.3874 | | 0.3802 | 0.3916 | | 0.3782 | 0.3837 |
| | 0.3782 | 0.3837 | | 0.3802 | 0.3916 | | 0.3869 | 0.3958 | | 0.3847 | 0.3877 |
| | 0.3763 | 0.3760 | | 0.3782 | 0.3837 | | 0.3847 | 0.3877 | | 0.3825 | 0.3798 |
| 5C1 | 0.3825 | 0.3798 | 5C2 | 0.3847 | 0.3877 | 5C3 | 0.3912 | 0.3917 | 5C4 | 0.3887 | 0.3836 |
| | 0.3847 | 0.3877 | | 0.3869 | 0.3958 | | 0.3937 | 0.4001 | | 0.3912 | 0.3917 |
| | 0.3912 | 0.3917 | | 0.3937 | 0.4001 | | 0.4006 | 0.4044 | | 0.3978 | 0.3958 |
| | 0.3887 | 0.3836 | | 0.3912 | 0.3917 | | 0.3978 | 0.3958 | | 0.3950 | 0.3875 |
| 5D1 | 0.3783 | 0.3646 | 5D2 | 0.3804 | 0.3721 | 5D3 | 0.3863 | 0.3758 | 5D4 | 0.3840 | 0.3681 |
| | 0.3804 | 0.3721 | | 0.3825 | 0.3798 | | 0.3887 | 0.3836 | | 0.3863 | 0.3758 |
| | 0.3863 | 0.3758 | | 0.3887 | 0.3836 | | 0.3950 | 0.3875 | | 0.3924 | 0.3794 |
| | 0.3840 | 0.3681 | | 0.3863 | 0.3758 | | 0.3924 | 0.3794 | | 0.3898 | 0.3716 |
| 6A1 | 0.3889 | 0.3690 | 6A2 | 0.3915 | 0.3768 | 6A3 | 0.3981 | 0.3800 | 6A4 | 0.3953 | 0.3720 |
| | 0.3915 | 0.3768 | | 0.3941 | 0.3848 | | 0.4010 | 0.3882 | | 0.3981 | 0.3800 |
| | 0.3981 | 0.3800 | | 0.4010 | 0.3882 | | 0.4080 | 0.3916 | | 0.4048 | 0.3832 |
| | 0.3953 | 0.3720 | | 0.3981 | 0.3800 | | 0.4048 | 0.3832 | | 0.4017 | 0.3751 |
| 6B1 | 0.3941 | 0.3848 | 6B2 | 0.3968 | 0.3930 | 6B3 | 0.4040 | 0.3966 | 6B4 | 0.4010 | 0.3882 |
| | 0.3968 | 0.3930 | | 0.3996 | 0.4015 | | 0.4071 | 0.4052 | | 0.4040 | 0.3966 |
| | 0.4040 | 0.3966 | | 0.4071 | 0.4052 | | 0.4146 | 0.4089 | | 0.4113 | 0.4001 |
| | 0.4010 | 0.3882 | | 0.4040 | 0.3966 | | 0.4113 | 0.4001 | | 0.4080 | 0.3916 |
| 6C1 | 0.4080 | 0.3916 | 6C2 | 0.4113 | 0.4001 | 6C3 | 0.4186 | 0.4037 | 6C4 | 0.4150 | 0.3950 |
| | 0.4113 | 0.4001 | | 0.4146 | 0.4089 | | 0.4222 | 0.4127 | | 0.4186 | 0.4037 |
| | 0.4186 | 0.4037 | | 0.4222 | 0.4127 | | 0.4299 | 0.4165 | | 0.4259 | 0.4073 |
| | 0.4150 | 0.3950 | | 0.4186 | 0.4037 | | 0.4259 | 0.4073 | | 0.4221 | 0.3984 |
| 6D1 | 0.4017 | 0.3751 | 6D2 | 0.4048 | 0.3832 | 6D3 | 0.4116 | 0.3865 | 6D4 | 0.4082 | 0.3782 |
| | 0.4048 | 0.3832 | | 0.4080 | 0.3916 | | 0.4150 | 0.3950 | | 0.4116 | 0.3865 |
| | 0.4116 | 0.3865 | | 0.4150 | 0.3950 | | 0.4221 | 0.3984 | | 0.4183 | 0.3898 |
| | 0.4082 | 0.3782 | | 0.4116 | 0.3865 | | 0.4183 | 0.3898 | | 0.4147 | 0.3814 |
| 7A1 | 0.4147 | 0.3814 | 7A2 | 0.4183 | 0.3898 | 7A3 | 0.4242 | 0.3919 | 7A4 | 0.4203 | 0.3833 |
| | 0.4183 | 0.3898 | | 0.4221 | 0.3984 | | 0.4281 | 0.4006 | | 0.4242 | 0.3919 |
| | 0.4242 | 0.3919 | | 0.4281 | 0.4006 | | 0.4342 | 0.4028 | | 0.4300 | 0.3939 |
| | 0.4203 | 0.3833 | | 0.4242 | 0.3919 | | 0.4300 | 0.3939 | | 0.4259 | 0.3853 |

PERFORMANCE GROUPS - CHROMATICITY (CONTINUED)

| Region | x | y | Region | x | y | Region | x | y | Region | x | y |
|--------|--------|--------|--------|--------|--------|--------|--------|--------|--------|--------|--------|
| 7B1 | 0.4221 | 0.3984 | 7B2 | 0.4259 | 0.4073 | 7B3 | 0.4322 | 0.4096 | 7B4 | 0.4281 | 0.4006 |
| | 0.4259 | 0.4073 | | 0.4299 | 0.4165 | | 0.4364 | 0.4188 | | 0.4322 | 0.4096 |
| | 0.4322 | 0.4096 | | 0.4364 | 0.4188 | | 0.4430 | 0.4212 | | 0.4385 | 0.4119 |
| | 0.4281 | 0.4006 | | 0.4322 | 0.4096 | | 0.4385 | 0.4119 | | 0.4342 | 0.4028 |
| 7C1 | 0.4342 | 0.4028 | 7C2 | 0.4385 | 0.4119 | 7C3 | 0.4449 | 0.4141 | 7C4 | 0.4403 | 0.4049 |
| | 0.4385 | 0.4119 | | 0.4430 | 0.4212 | | 0.4496 | 0.4236 | | 0.4449 | 0.4141 |
| | 0.4449 | 0.4141 | | 0.4496 | 0.4236 | | 0.4562 | 0.4260 | | 0.4513 | 0.4164 |
| | 0.4403 | 0.4049 | | 0.4449 | 0.4141 | | 0.4513 | 0.4164 | | 0.4465 | 0.4071 |
| 7D1 | 0.4259 | 0.3853 | 7D2 | 0.4300 | 0.3939 | 7D3 | 0.4359 | 0.3960 | 7D4 | 0.4316 | 0.3873 |
| | 0.4300 | 0.3939 | | 0.4342 | 0.4028 | | 0.4403 | 0.4049 | | 0.4359 | 0.3960 |
| | 0.4359 | 0.3960 | | 0.4403 | 0.4049 | | 0.4465 | 0.4071 | | 0.4418 | 0.3981 |
| | 0.4316 | 0.3873 | | 0.4359 | 0.3960 | | 0.4418 | 0.3981 | | 0.4373 | 0.3893 |
| 8A1 | 0.4373 | 0.3893 | 8A2 | 0.4418 | 0.3981 | 8A3 | 0.4475 | 0.3994 | 8A4 | 0.4428 | 0.3906 |
| | 0.4418 | 0.3981 | | 0.4465 | 0.4071 | | 0.4523 | 0.4085 | | 0.4475 | 0.3994 |
| | 0.4475 | 0.3994 | | 0.4523 | 0.4085 | | 0.4582 | 0.4099 | | 0.4532 | 0.4008 |
| | 0.4428 | 0.3906 | | 0.4475 | 0.3994 | | 0.4532 | 0.4008 | | 0.4483 | 0.3919 |
| 8B1 | 0.4465 | 0.4071 | 8B2 | 0.4513 | 0.4164 | 8B3 | 0.4573 | 0.4178 | 8B4 | 0.4523 | 0.4085 |
| | 0.4513 | 0.4164 | | 0.4562 | 0.4260 | | 0.4624 | 0.4274 | | 0.4573 | 0.4178 |
| | 0.4573 | 0.4178 | | 0.4624 | 0.4274 | | 0.4687 | 0.4289 | | 0.4634 | 0.4193 |
| | 0.4523 | 0.4085 | | 0.4573 | 0.4178 | | 0.4634 | 0.4193 | | 0.4582 | 0.4099 |
| 8C1 | 0.4582 | 0.4099 | 8C2 | 0.4634 | 0.4193 | 8C3 | 0.4695 | 0.4207 | 8C4 | 0.4641 | 0.4112 |
| | 0.4634 | 0.4193 | | 0.4687 | 0.4289 | | 0.4750 | 0.4304 | | 0.4695 | 0.4207 |
| | 0.4695 | 0.4207 | | 0.4750 | 0.4304 | | 0.4813 | 0.4319 | | 0.4756 | 0.4221 |
| | 0.4641 | 0.4112 | | 0.4695 | 0.4207 | | 0.4756 | 0.4221 | | 0.4700 | 0.4126 |
| 8D1 | 0.4483 | 0.3919 | 8D2 | 0.4532 | 0.4008 | 8D3 | 0.4589 | 0.4021 | 8D4 | 0.4538 | 0.3931 |
| | 0.4532 | 0.4008 | | 0.4582 | 0.4099 | | 0.4641 | 0.4112 | | 0.4589 | 0.4021 |
| | 0.4589 | 0.4021 | | 0.4641 | 0.4112 | | 0.4700 | 0.4126 | | 0.4646 | 0.4034 |
| | 0.4538 | 0.3931 | | 0.4589 | 0.4021 | | 0.4646 | 0.4034 | | 0.4593 | 0.3944 |
| AA1 | 0.4822 | 0.3973 | AA2 | 0.4884 | 0.4067 | AA3 | 0.4942 | 0.4066 | AA4 | 0.4879 | 0.3972 |
| | 0.4884 | 0.4067 | | 0.4946 | 0.4162 | | 0.5006 | 0.4160 | | 0.4942 | 0.4066 |
| | 0.4942 | 0.4066 | | 0.5006 | 0.4160 | | 0.5066 | 0.4158 | | 0.5001 | 0.4064 |
| | 0.4879 | 0.3972 | | 0.4942 | 0.4066 | | 0.5001 | 0.4064 | | 0.4936 | 0.3970 |
| AB1 | 0.4946 | 0.4162 | AB2 | 0.5008 | 0.4256 | AB3 | 0.5069 | 0.4254 | AB4 | 0.5006 | 0.4160 |
| | 0.5008 | 0.4256 | | 0.5070 | 0.4350 | | 0.5133 | 0.4348 | | 0.5069 | 0.4254 |
| | 0.5069 | 0.4254 | | 0.5133 | 0.4348 | | 0.5196 | 0.4346 | | 0.5131 | 0.4252 |
| | 0.5006 | 0.4160 | | 0.5069 | 0.4254 | | 0.5131 | 0.4252 | | 0.5066 | 0.4158 |

PERFORMANCE GROUPS - CHROMATICITY (CONTINUED)

| Region | x | y | Region | x | y | Region | x | y | Region | x | y |
|--------|--------|--------|--------|--------|--------|--------|--------|--------|--------|--------|--------|
| AC1 | 0.5066 | 0.4158 | AC2 | 0.5131 | 0.4252 | AC3 | 0.5192 | 0.4250 | AC4 | 0.5126 | 0.4156 |
| | 0.5131 | 0.4252 | | 0.5196 | 0.4346 | | 0.5258 | 0.4343 | | 0.5192 | 0.4250 |
| | 0.5192 | 0.4250 | | 0.5258 | 0.4343 | | 0.5321 | 0.4341 | | 0.5253 | 0.4248 |
| | 0.5126 | 0.4156 | | 0.5192 | 0.4250 | | 0.5253 | 0.4248 | | 0.5186 | 0.4154 |
| AD1 | 0.4936 | 0.3970 | AD2 | 0.5001 | 0.4064 | AD3 | 0.5059 | 0.4062 | AD4 | 0.4993 | 0.3969 |
| | 0.5001 | 0.4064 | | 0.5066 | 0.4158 | | 0.5126 | 0.4156 | | 0.5059 | 0.4062 |
| | 0.5059 | 0.4062 | | 0.5126 | 0.4156 | | 0.5186 | 0.4154 | | 0.5118 | 0.4061 |
| | 0.4993 | 0.3969 | | 0.5059 | 0.4062 | | 0.5118 | 0.4061 | | 0.5050 | 0.3967 |

XLamp XP-G3 White LEDs are tested for chromaticity and placed into one of the regions defined by the following bounding coordinates.

| EasyWhite Color Temperatures – 3-Step Ellipse | | | | | | |
|---|--------|--------------|--------|------------|------------|--------------------|
| Bin Code | CCT | Center Point | | Major Axis | Minor Axis | Rotation Angle (°) |
| | | x | y | a | b | |
| 6G | 3500 K | 0.4073 | 0.3917 | 0.00927 | 0.00414 | 53.2 |
| 7G | 3000 K | 0.4338 | 0.4030 | 0.00834 | 0.00408 | 53.2 |
| 8G | 2700 K | 0.4577 | 0.4099 | 0.00834 | 0.00420 | 48.5 |

| EasyWhite Color Temperatures – 5-Step Ellipse | | | | | | |
|---|--------|--------------|--------|------------|------------|--------------------|
| Bin Code | CCT | Center Point | | Major Axis | Minor Axis | Rotation Angle (°) |
| | | x | y | a | b | |
| 2E | 5700 K | 0.3287 | 0.3417 | 0.01230 | 0.00600 | 72.0 |
| 3E | 5000 K | 0.3447 | 0.3553 | 0.01400 | 0.00520 | 65.0 |
| 4E | 4500 K | 0.3611 | 0.3658 | 0.01420 | 0.00550 | 61.5 |
| 5E | 4000 K | 0.3818 | 0.3797 | 0.01565 | 0.00670 | 53.7 |
| 6E | 3500 K | 0.4073 | 0.3917 | 0.01545 | 0.00690 | 54.0 |
| 7E | 3000 K | 0.4338 | 0.4030 | 0.01390 | 0.00680 | 53.2 |
| 8E | 2700 K | 0.4577 | 0.4099 | 0.01350 | 0.00700 | 48.5 |
| BE | 1800 K | 0.5492 | 0.4082 | 0.01546 | 0.00683 | 50.0 |

STANDARD COOL WHITE KITS PLOTTED ON ANSI STANDARD CHROMATICITY REGIONS

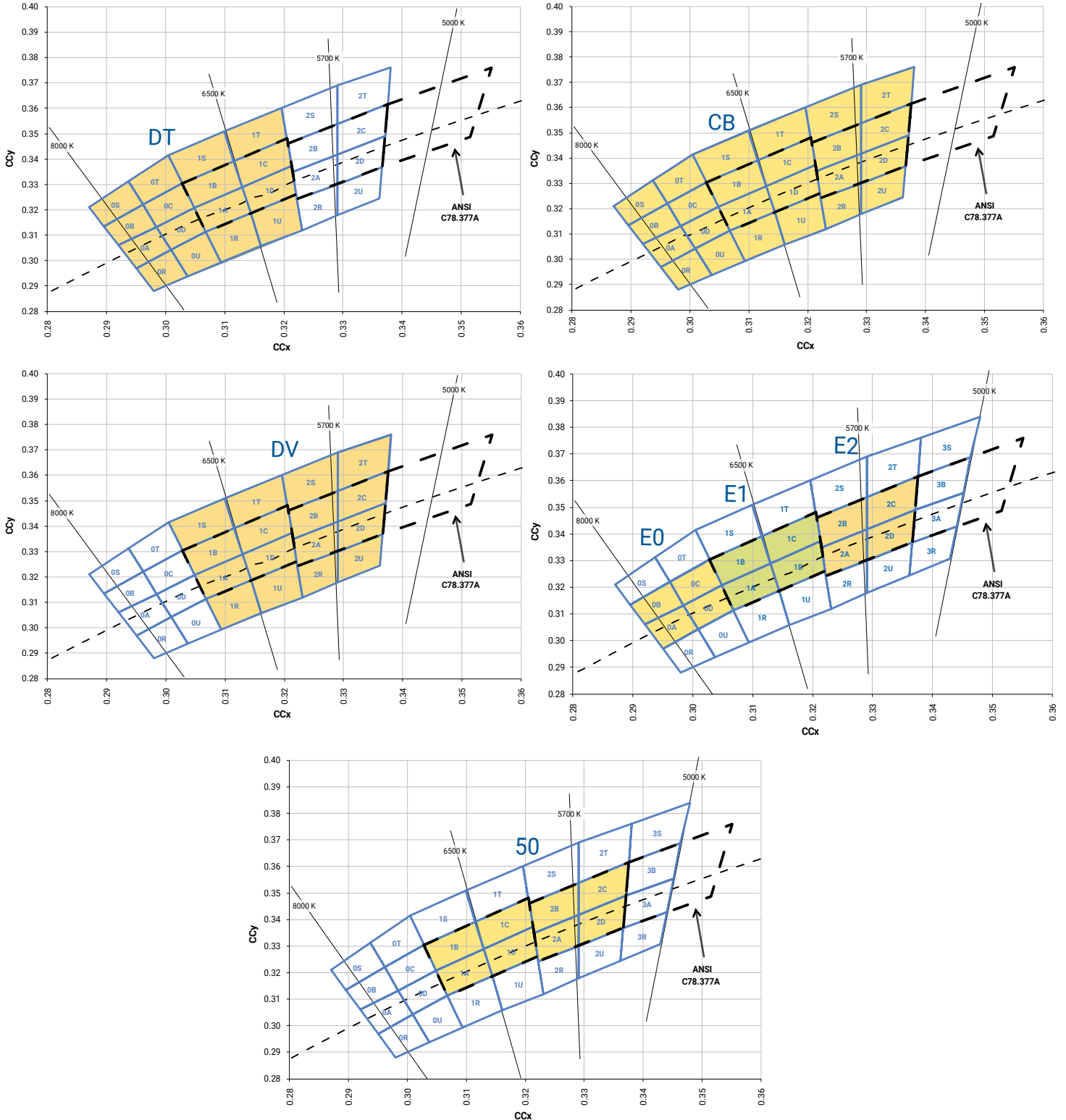

STANDARD WARM AND NEUTRAL WHITE KITS PLOTTED ON ANSI STANDARD CHROMATICITY REGIONS

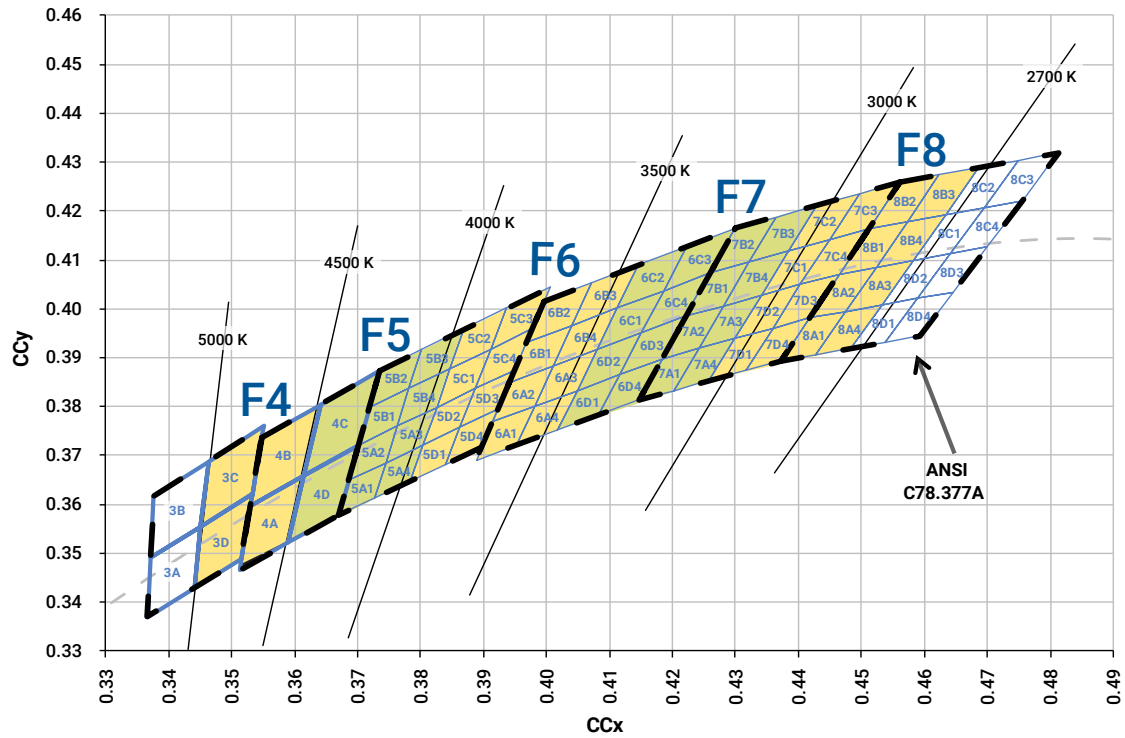
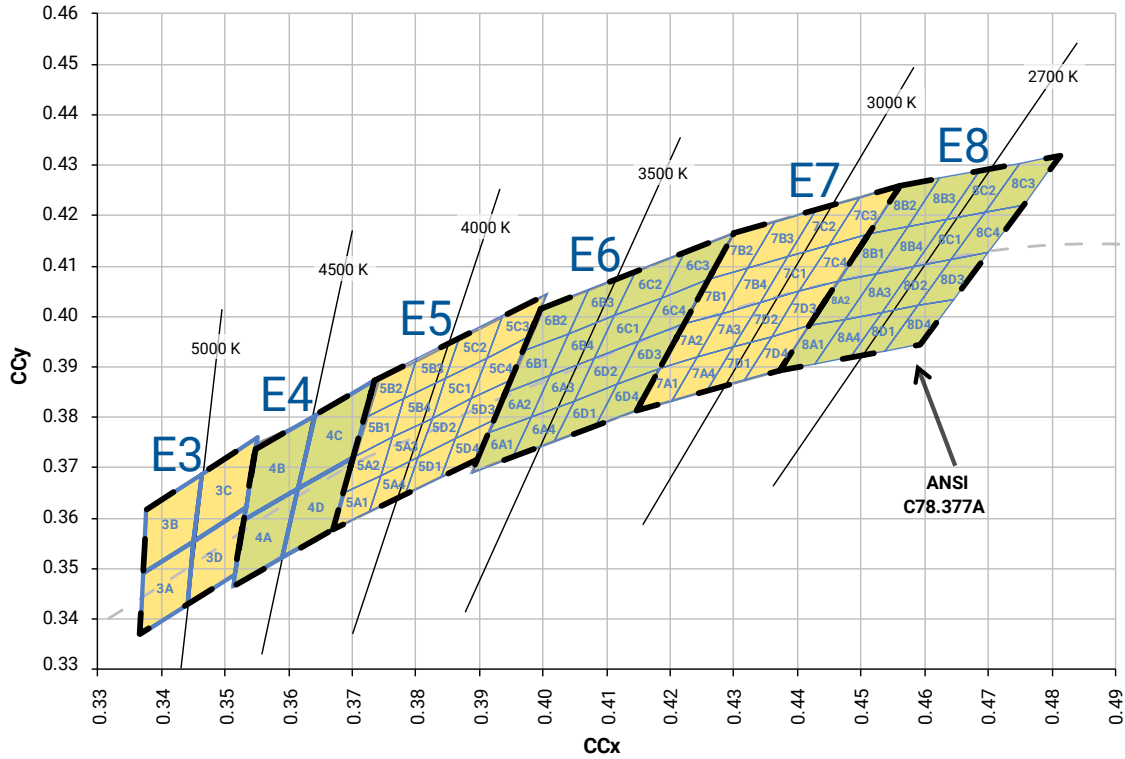

STANDARD WARM AND NEUTRAL WHITE KITS PLOTTED ON ANSI STANDARD CHROMATICITY REGIONS - CONTINUED

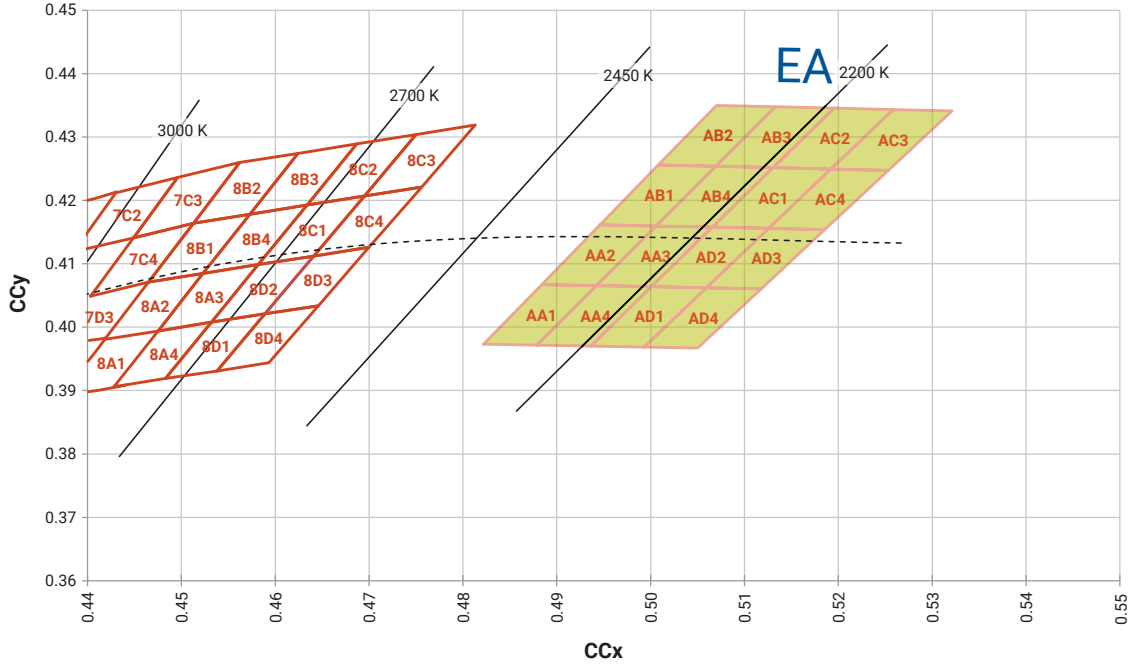

EASYWHITE® WHITE KITS PLOTTED ON ANSI STANDARD CHROMATICITY REGIONS

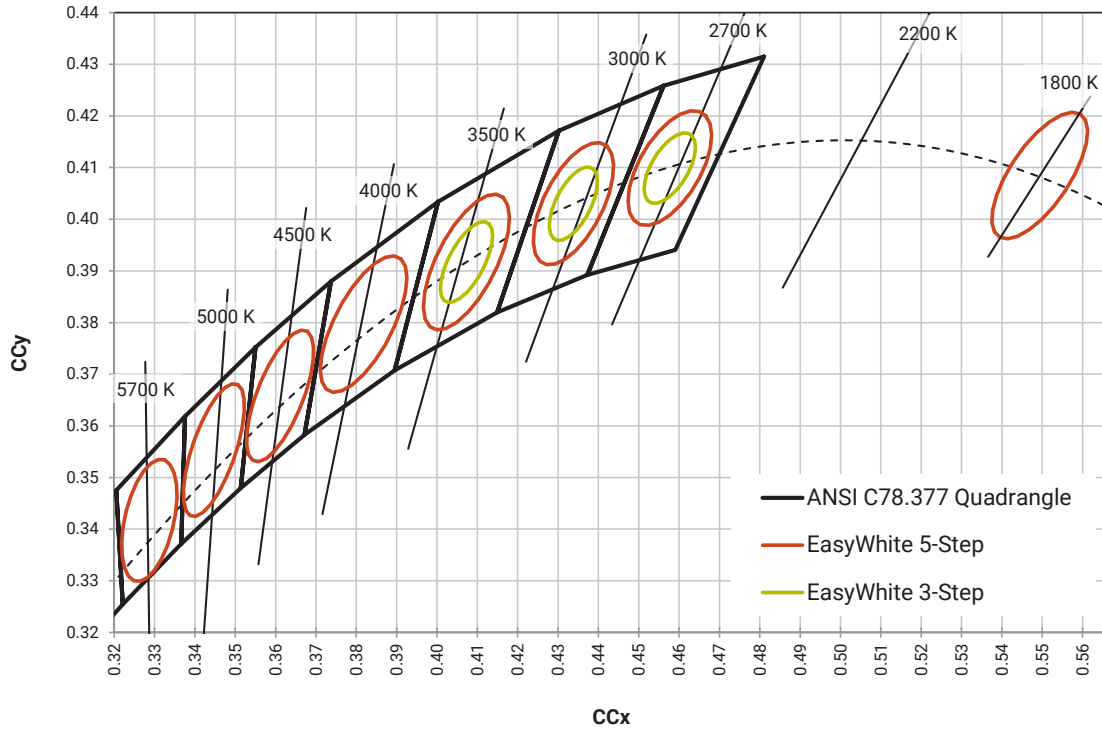

STANDARD CHROMATICITY KITS

The following table provides the chromaticity bins associated with chromaticity kits.

| Color | CCT | Kit | Chromaticity Bins |
|---------------|---------|-----|--|
| Cool White | 7000 K | DT | 0A, 0B, 0C, 0D, 0R, 0S, 0T, 0U, 1A, 1B, 1C, 1D, 1R, 1S, 1T, 1U |
| | 6500 K | CB | 0A, 0B, 0C, 0D, 0R, 0S, 0T, 0U, 1A, 1B, 1C, 1D, 1R, 1S, 1T, 1U, 2A, 2B, 2C, 2D, 2R, 2S, 2T, 2U |
| | >6500 K | E0 | 0A, 0B, 0C, 0D |
| | 6500 K | E1 | 1A, 1B, 1C, 1D |
| | 6000 K | DV | 1A, 1B, 1C, 1D, 1R, 1S, 1T, 1U, 2A, 2B, 2C, 2D, 2R, 2S, 2T, 2U |
| | 6200 K | 50 | 1A, 1B, 1C, 1D, 2A, 2B, 2C, 2D |
| | 5700 K | E2 | 2A, 2B, 2C, 2D |
| | 5700 K | 2E | 57E |
| Neutral White | 5000 K | 3E | 50E |
| | 5000 K | E3 | 3A, 3B, 3C, 3D |
| | 4750 K | F4 | 3C, 3D, 4A, 4B |
| | 4500 K | 4E | 45E |
| | 4500 K | E4 | 4A, 4B, 4C, 4D |
| | 4250 K | F5 | 4C, 4D, 5A1, 5A2, 5A3, 5A4, 5B1, 5B2, 5B3, 5B4 |
| | 4000 K | 5E | 40E |
| | 4000 K | E5 | 5A1, 5A2, 5A3, 5A4, 5B1, 5B2, 5B3, 5B4, 5C1, 5C2, 5C3, 5C4, 5D1, 5D2, 5D3, 5D4 |
| Warm White | 3750 K | F6 | 5C1, 5C2, 5C3, 5C4, 5D1, 5D2, 5D3, 5D4, 6A1, 6A2, 6A3, 6A4, 6B1, 6B2, 6B3, 6B4 |
| | 3500 K | 6E | 35E, 35G |
| | 3500 K | 6G | 35G |
| | 3500 K | E6 | 6A1, 6A2, 6A3, 6A4, 6B1, 6B2, 6B3, 6B4, 6C1, 6C2, 6C3, 6C4, 6D1, 6D2, 6D3, 6D4 |
| | 3250 K | F7 | 6C1, 6C2, 6C3, 6C4, 6D1, 6D2, 6D3, 6D4, 7A1, 7A2, 7A3, 7A4, 7B1, 7B2, 7B3, 7B4 |
| | 3000 K | 7E | 30E, 30G |
| | 3000 K | 7G | 30G |
| | 3000 K | E7 | 7A1, 7A2, 7A3, 7A4, 7B1, 7B2, 7B3, 7B4, 7C1, 7C2, 7C3, 7C4, 7D1, 7D2, 7D3, 7D4 |
| | 2850 K | F8 | 7C1, 7C2, 7C3, 7C4, 7D1, 7D2, 7D3, 7D4, 8A1, 8A2, 8A3, 8A4, 8B1, 8B2, 8B3, 8B4 |
| | 2700 K | 8E | 27E, 27G |
| | 2700 K | 8G | 27G |
| | 2700 K | E8 | 8A1, 8A2, 8A3, 8A4, 8B1, 8B2, 8B3, 8B4, 8C1, 8C2, 8C3, 8C4, 8D1, 8D2, 8D3, 8D4 |
| | 2200 K | EA | AA1, AA2, AA3, AA4, AB1, AB2, AB3, AB4, AC1, AC2, AC3, AC4, AD1, AD2, AD3, AD4 |
| | 1800 K | BE | 18E |

BIN AND ORDER CODE FORMATS

XP-G3 bin codes and order codes are configured in the following manner:

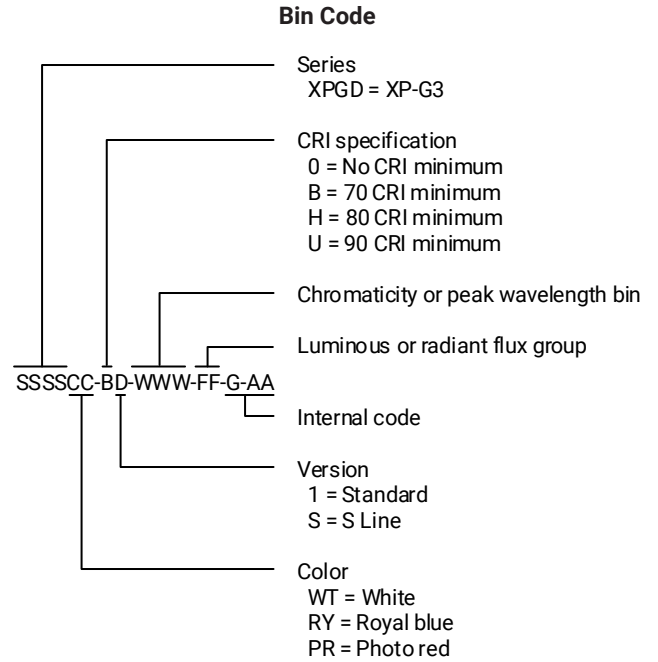
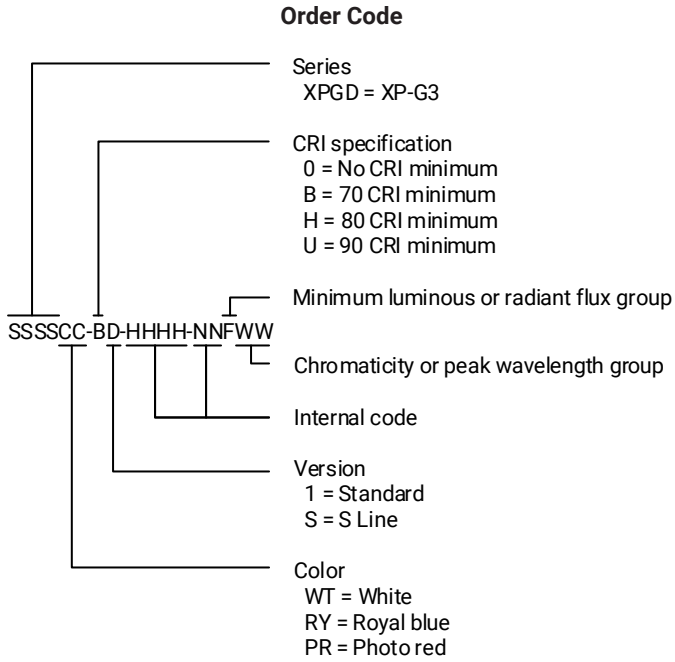

REFLOW SOLDERING CHARACTERISTICS

In testing, Cree LED has found XLamp XP-G3 LEDs to be compatible with JEDEC J-STD-020C, with the exception of the peak temperature requirements listed in the table below. As a general guideline, Cree LED recommends that users follow the recommended soldering profile provided by the manufacturer of the solder paste used, and therefore it is the lamp or luminaire manufacturer’s responsibility to determine applicable soldering requirements.

Note that this general guideline may not apply to all PCB designs and configurations of reflow soldering equipment.

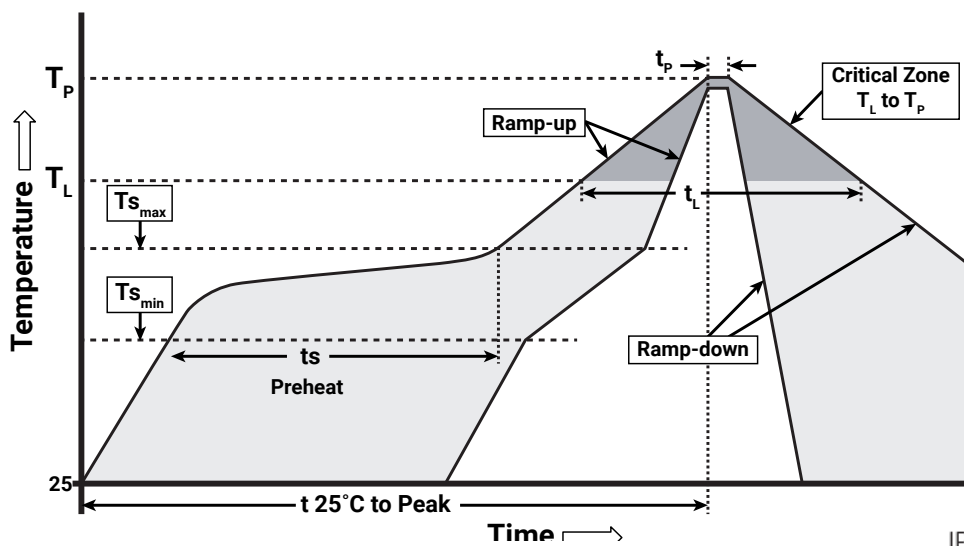

IPC/JEDEC J-STD-020C

| Profile Feature | Lead-Free Solder |
|---|------------------|
| Average Ramp-Up Rate ($T_{s_{max}}$ to T_p) | 1.2 °C/second |
| Preheat: Temperature Min ($T_{s_{min}}$) | 120 °C |
| Preheat: Temperature Max ($T_{s_{max}}$) | 170 °C |
| Preheat: Time ($t_{s_{min}}$ to $t_{s_{max}}$) | 65-150 seconds |
| Time Maintained Above: Temperature (T_L) | 217 °C |
| Time Maintained Above: Time (t_L) | 45-90 seconds |
| Peak/Classification Temperature (T_p) | 235 - 245 °C |
| Time Within 5 °C of Actual Peak Temperature (t_p) | 20-40 seconds |
| Ramp-Down Rate | 1 - 6 °C/second |
| Time 25 °C to Peak Temperature | 4 minutes max. |

Note: All temperatures refer to topside of the package, measured on the package body surface.

NOTES

Measurements

The luminous flux, radiant power, chromaticity, forward voltage and CRI measurements in this document are binning specifications only and solely represent product measurements as of the date of shipment. These measurements will change over time based on a number of factors that are not within Cree LED's control and are not intended or provided as operational specifications for the products. Calculated values are provided for informational purposes only and are not intended or provided as specifications.

Pre-Release Qualification Testing

Please read the [LED Reliability Overview](#) for details of the qualification process Cree LED applies to ensure long-term reliability for XLamp LEDs and details of Cree LED's pre-release qualification testing for XLamp LEDs. Cree LED did not perform Room Temperature Operating Life (RTOL) testing on the XP-G3 LED.

Lumen Maintenance

Cree LED now uses standardized IES LM-80-08 and TM-21-11 methods for collecting long-term data and extrapolating LED lumen maintenance. For information on the specific LM-80 data sets available for this LED, refer to the public [LM-80 results document](#).

Please read the [Long-Term Lumen Maintenance application note](#) for more details on Cree LED's lumen maintenance testing and forecasting. Please read the [Thermal Management application note](#) for details on how thermal design, ambient temperature, and drive current affect the LED junction temperature.

Moisture Sensitivity

Cree LED recommends keeping XLamp LEDs in the provided, resealable moisture-barrier packaging (MBP) until immediately prior to soldering. Unopened MBPs that contain XLamp LEDs do not need special storage for moisture sensitivity.

Once the MBP is opened, XLamp XP-G3 LEDs may be stored as MSL 1 per JEDEC J-STD-033, meaning they have unlimited floor life in conditions of ≤ 30 °C/85% relative humidity (RH). Regardless of the storage condition, Cree LED recommends sealing any unsoldered LEDs in the original MBP.

RoHS Compliance

The levels of RoHS restricted materials in this product are below the maximum concentration values (also referred to as the threshold limits) permitted for such substances, or are used in an exempted application, in accordance with EU Directive 2011/65/EC (RoHS2), as implemented January 2, 2013. RoHS Declarations for this product can be obtained from your Cree LED representative or from the [Product Ecology](#) section of the Cree LED website.

REACH Compliance

REACH substances of very high concern (SVHCs) information is available for this product. Since the European Chemical Agency (ECHA) has published notice of their intent to frequently revise the SVHC listing for the foreseeable future, please contact a Cree LED representative to insure you get the most up-to-date REACH Declaration. REACH banned substance information (REACH Article 67) is also available upon request.

NOTES - CONTINUED

UL® Recognized Component

This product meets the requirements to be considered a UL Recognized Component with Level 4 enclosure consideration. The LED package or a portion thereof has been investigated as a fire and electrical enclosure per ANSI/UL 8750.

Vision Advisory

WARNING: Do not look at an exposed lamp in operation. Eye injury can result. For more information about LEDs and eye safety, please refer to the [LED Eye Safety application note](#).

MECHANICAL DIMENSIONS (T_A = 25 °C)

Thermal vias, if present, are not shown on these drawings.

All measurements are ±.13 mm unless otherwise indicated.

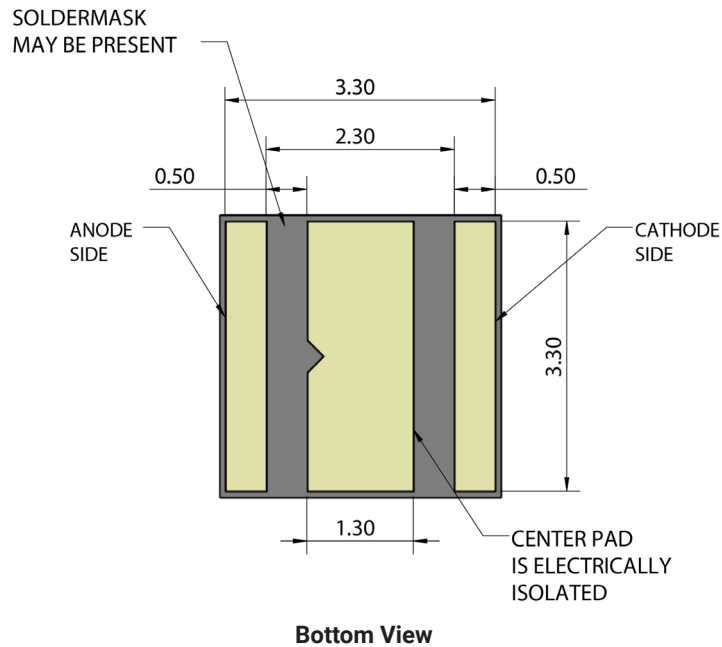
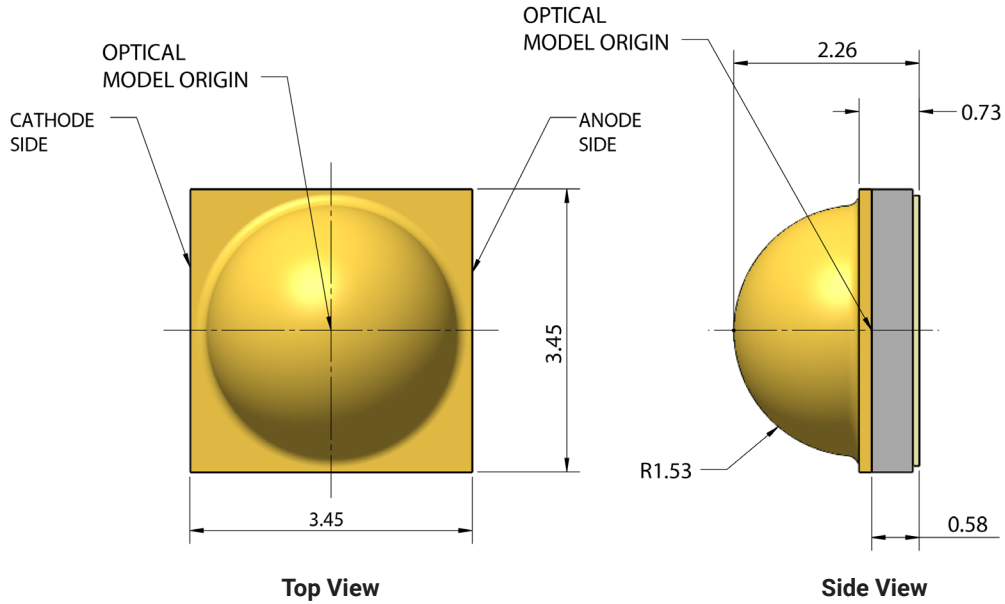

MECHANICAL DIMENSIONS (T_A = 25 °C) - CONTINUED

All measurements are ±.13 mm unless otherwise indicated.

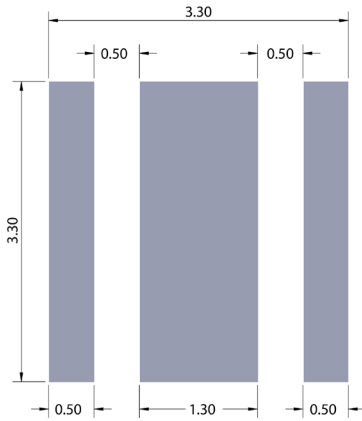

Recommended PCB Footprint

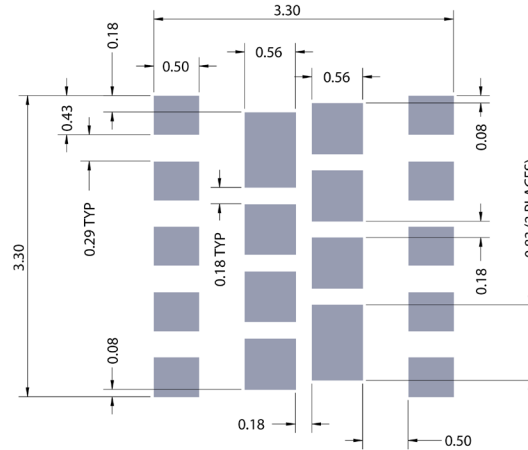

Recommended Stencil Openings*

Notes:

- Cree LED recommends using thermal pad kickouts to maximize component thermal performance.
- Cree LED recommends using white solder mask material to minimize system optical loss.
- * This stencil has been tested and optimized for the avoidance of voiding when using ALPHA® LUMET® P30 Maxrel solder paste. For other solder pastes, a “window pane” design for the thermal pad stencil may result in a lower voiding percentage. Contact your local Cree LED Field Applications Engineer for consultation regarding your specific application.

TAPE AND REEL

All Cree LED carrier tapes conform to EIA-481D, Automated Component Handling Systems Standard.

All dimensions in mm.

All measurements are ± 0.15 mm unless otherwise indicated.

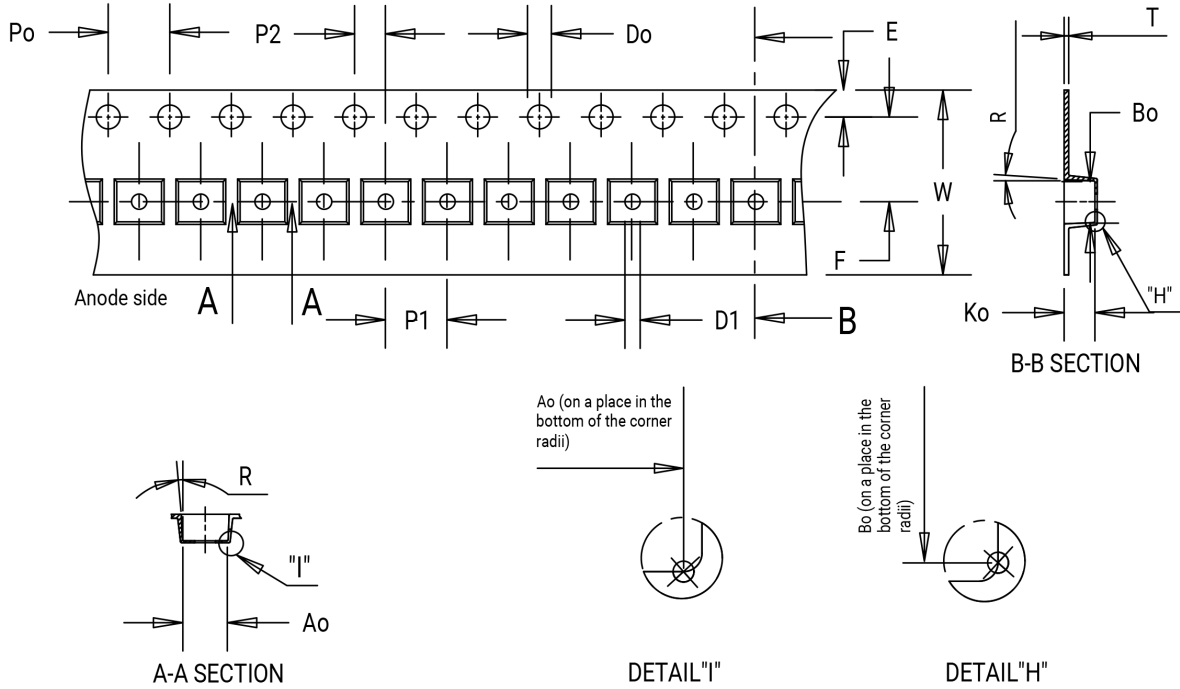

| Item | A_0 | B_0 | K_0 | P_0 | P_1 | P_2 | T | E | F | D_0 | D_1 | W | R |
|------|-------|-------|-------|-------|-------|-------|------|------|------|-------|-------|-------|-----|
| Dim. | 3.70 | 3.70 | 2.40 | 4.00 | 8.00 | 2.00 | 0.30 | 1.75 | 5.50 | 1.55 | 1.50 | 12.00 | 5° |

TAPE AND REEL - CONTINUED

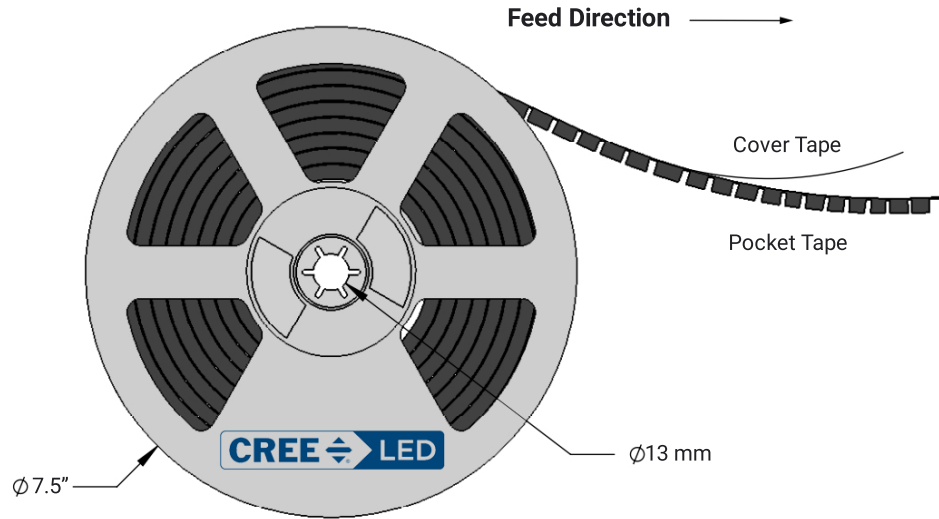
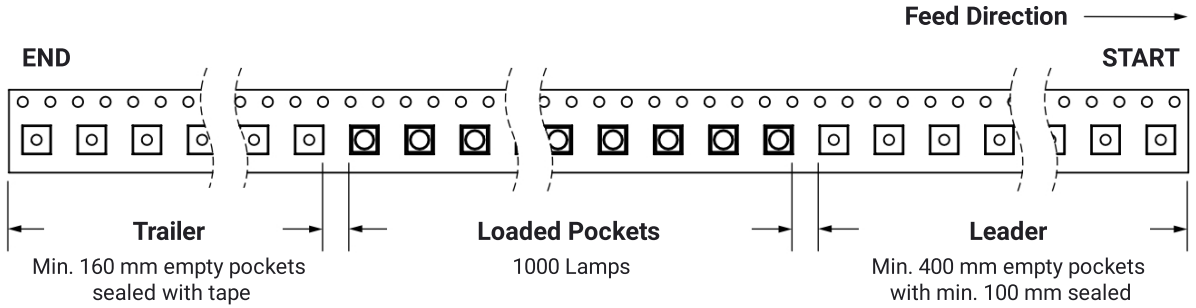

PACKAGING

Unpackaged Reel

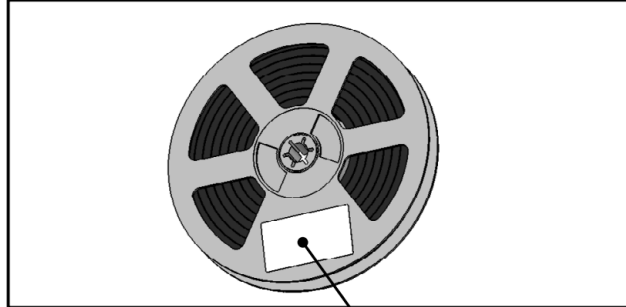

Label with Cree LED Bin Code, Quantity, Reel ID

Packaged Reel

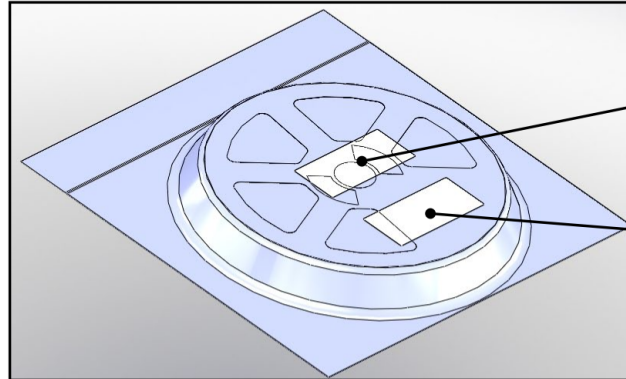

Label with Cree LED Order Code, Quantity, Reel ID, PO#

Label with Cree LED Bin Code, Quantity, Reel ID

Boxed Reel

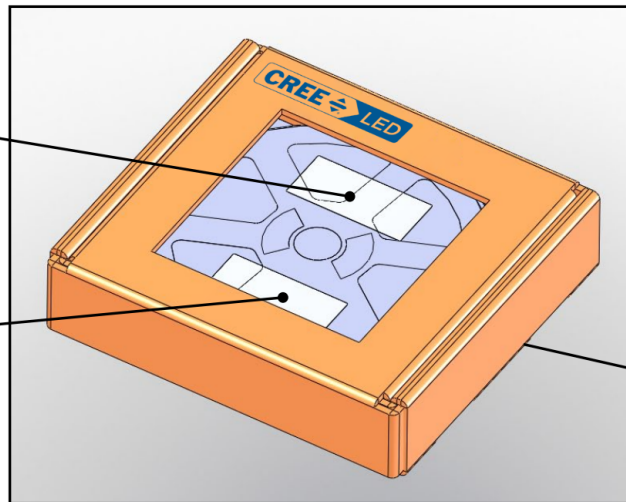

Label with Cree LED Order Code, Quantity, Reel ID, PO#

Label with Cree LED Bin Code, Quantity, Reel ID

Patent Label (on bottom of box)

APPENDIX - ORDER CODES NOT FOR NEW DESIGNS

The following order codes are active and valid order codes, but higher performance options are also available. Please see page 4 - page 9 for order codes of XLamp XP-G3 White (Standard) LEDs that could serve as alternatives for the order codes set forth below.

| Chromaticity | | Minimum Luminous Flux (lm) @ 350 mA | | | Order Codes | | | |
|--------------|---------|-------------------------------------|-------------------|--------------------|----------------------|----------------------|----------------------|----------------------|
| Kit | CCT | Code | Flux (lm) @ 85 °C | Flux (lm) @ 25 °C* | 70 CRI Typical | 70 CRI Minimum | 80 CRI Minimum | 90 CRI Minimum |
| DT | 7000 K | S2 | 148 | 161 | | XPGDWT-B1-0000-00JDT | XPGDWT-H1-0000-00JDT | |
| | | R5 | 139 | 152 | | | XPGDWT-H1-0000-00HDT | |
| CB | 6500 K | S2 | 148 | 161 | | | XPGDWT-H1-0000-00JCB | |
| | | R5 | 139 | 152 | | | XPGDWT-H1-0000-00HCB | |
| E0 | >6500 K | S3 | 156 | 170 | XPGDWT-01-0000-00KE0 | | | |
| | | S2 | 148 | 161 | XPGDWT-01-0000-00JE0 | XPGDWT-B1-0000-00JE0 | XPGDWT-H1-0000-00JE0 | |
| | | R5 | 139 | 152 | | | XPGDWT-H1-0000-00HE0 | |
| E1 | 6500 K | S3 | 156 | 170 | XPGDWT-01-0000-00KE1 | | | |
| | | S2 | 148 | 161 | XPGDWT-01-0000-00JE1 | XPGDWT-B1-0000-00JE1 | XPGDWT-H1-0000-00JE1 | |
| | | R5 | 139 | 152 | | | XPGDWT-H1-0000-00HE1 | |
| DV | 6000 K | S3 | 156 | 170 | XPGDWT-01-0000-00KDV | | | |
| | | S2 | 148 | 161 | XPGDWT-01-0000-00JDV | XPGDWT-B1-0000-00JDV | XPGDWT-H1-0000-00JDV | |
| | | R5 | 139 | 152 | | | XPGDWT-H1-0000-00HDV | |
| | | R4 | 130 | 142 | | | | |
| | | R3 | 122 | 133 | | | | XPGDWT-U1-0000-00FDV |
| | | R2 | 114 | 124 | | | | XPGDWT-U1-0000-00EDV |
| 50 | 6000 K | S3 | 156 | 170 | XPGDWT-01-0000-00K50 | | | |
| | | S2 | 148 | 161 | XPGDWT-01-0000-00J50 | XPGDWT-B1-0000-00J50 | XPGDWT-H1-0000-00J50 | |
| | | R5 | 139 | 152 | | | XPGDWT-H1-0000-00H50 | |
| | | R4 | 130 | 142 | | | | |
| | | R3 | 122 | 133 | | | | XPGDWT-U1-0000-00F50 |
| | | R2 | 114 | 124 | | | | XPGDWT-U1-0000-00E50 |

Notes

- Cree LED maintains a tolerance of ±7% on flux and power measurements, ±0.005 on chromaticity (CCx, CCy) measurements and a tolerance of ±2 on CRI measurements. See the Measurements section (page 39).
- XLamp XP-G3 LED order codes specify only a minimum flux bin and not a maximum. Cree LED may ship reels in flux bins higher than the minimum specified by the order code without advance notice. Shipments will always adhere to the chromaticity bin restrictions specified by the order code.
- * Flux values @ 25 °C are calculated and for reference only.

APPENDIX - ORDER CODES NOT FOR NEW DESIGNS - CONTINUED

| Chromaticity | | Minimum Luminous Flux (lm) @ 350 mA | | | Order Codes | | | |
|--------------|--------|-------------------------------------|-------------------|--------------------|----------------------|----------------------|----------------------|----------------------|
| Kit | CCT | Code | Flux (lm) @ 85 °C | Flux (lm) @ 25 °C* | 70 CRI Typical | 70 CRI Minimum | 80 CRI Minimum | 90 CRI Minimum |
| E2 | 5700 K | S3 | 156 | 170 | XPGDWT-01-0000-00KE2 | | | |
| | | S2 | 148 | 161 | XPGDWT-01-0000-00JE2 | XPGDWT-B1-0000-00JE2 | XPGDWT-H1-0000-00JE2 | |
| | | R5 | 139 | 152 | | | XPGDWT-H1-0000-00HE2 | |
| | | R4 | 130 | 142 | | | | |
| | | R3 | 122 | 133 | | | | XPGDWT-U1-0000-00FE2 |
| | | R2 | 114 | 124 | | | | XPGDWT-U1-0000-00EE2 |
| 2E | 5700 K | S2 | 148 | 161 | | XPGDWT-B1-0000-00J2E | XPGDWT-H1-0000-00J2E | |
| | | R5 | 139 | 152 | | | XPGDWT-H1-0000-00H2E | |
| | | R4 | 130 | 142 | | | | |
| | | R3 | 122 | 133 | | | | XPGDWT-U1-0000-00F2E |
| | | R2 | 114 | 124 | | | | XPGDWT-U1-0000-00E2E |
| 3E | 5000 K | S2 | 148 | 161 | | XPGDWT-B1-0000-00J3E | XPGDWT-H1-0000-00J3E | |
| | | R5 | 139 | 152 | | | XPGDWT-H1-0000-00H3E | |
| | | R4 | 130 | 142 | | | | |
| | | R3 | 122 | 133 | | | | XPGDWT-U1-0000-00F3E |
| | | R2 | 114 | 124 | | | | XPGDWT-U1-0000-00E3E |
| E3 | 5000 K | S3 | 156 | 170 | XPGDWT-01-0000-00KE3 | XPGDWT-B1-0000-00KE3 | | |
| | | S2 | 148 | 161 | XPGDWT-01-0000-00JE3 | XPGDWT-B1-0000-00JE3 | XPGDWT-H1-0000-00JE3 | |
| | | R5 | 139 | 152 | | | XPGDWT-H1-0000-00HE3 | |
| | | R4 | 130 | 142 | | | | |
| | | R3 | 122 | 133 | | | | XPGDWT-U1-0000-00FE3 |
| | | R2 | 114 | 124 | | | | XPGDWT-U1-0000-00EE3 |
| F4 | 4750K | S3 | 156 | 170 | XPGDWT-01-0000-00KF4 | XPGDWT-B1-0000-00KF4 | | |
| | | S2 | 148 | 161 | XPGDWT-01-0000-00JF4 | XPGDWT-B1-0000-00JF4 | | |
| | | R5 | 139 | 152 | | XPGDWT-B1-0000-00HF4 | XPGDWT-H1-0000-00HF4 | |
| | | R4 | 130 | 142 | | | XPGDWT-H1-0000-00GF4 | |
| | | R3 | 122 | 133 | | | | XPGDWT-U1-0000-00FF4 |
| | | R2 | 114 | 124 | | | | XPGDWT-U1-0000-00EF4 |

Notes

- Cree LED maintains a tolerance of ±7% on flux and power measurements, ±0.005 on chromaticity (CCx, CCy) measurements and a tolerance of ±2 on CRI measurements. See the Measurements section (page 39).
- XLamp XP-G3 LED order codes specify only a minimum flux bin and not a maximum. Cree LED may ship reels in flux bins higher than the minimum specified by the order code without advance notice. Shipments will always adhere to the chromaticity bin restrictions specified by the order code.
- * Flux values @ 25 °C are calculated and for reference only.

APPENDIX - ORDER CODES NOT FOR NEW DESIGNS - CONTINUED

| Chromaticity | | Minimum Luminous Flux (lm) @ 350 mA | | | Order Codes | | | |
|--------------|--------|-------------------------------------|-------------------|--------------------|----------------------|----------------------|----------------------|----------------------|
| Kit | CCT | Code | Flux (lm) @ 85 °C | Flux (lm) @ 25 °C* | 70 CRI Typical | 70 CRI Minimum | 80 CRI Minimum | 90 CRI Minimum |
| 4E | 4500 K | S3 | 156 | 170 | | XPGDWT-B1-0000-00K4E | | |
| | | S2 | 148 | 161 | | XPGDWT-B1-0000-00J4E | | |
| | | R5 | 139 | 152 | | | XPGDWT-H1-0000-00H4E | |
| | | R4 | 130 | 142 | | | XPGDWT-H1-0000-00G4E | |
| | | R3 | 122 | 133 | | | | XPGDWT-U1-0000-00F4E |
| | | R2 | 114 | 124 | | | | XPGDWT-U1-0000-00E4E |
| | | Q5 | 107 | 117 | | | | XPGDWT-U1-0000-00D4E |
| E4 | 4500 K | S3 | 156 | 170 | XPGDWT-01-0000-00KE4 | XPGDWT-B1-0000-00KE4 | | |
| | | S2 | 148 | 161 | XPGDWT-01-0000-00JE4 | XPGDWT-B1-0000-00JE4 | | |
| | | R5 | 139 | 152 | | XPGDWT-B1-0000-00HE4 | XPGDWT-H1-0000-00HE4 | |
| | | R4 | 130 | 142 | | | XPGDWT-H1-0000-00GE4 | |
| | | R3 | 122 | 133 | | | | XPGDWT-U1-0000-00FE4 |
| | | R2 | 114 | 124 | | | | XPGDWT-U1-0000-00EE4 |
| | | Q5 | 107 | 117 | | | | XPGDWT-U1-0000-00DE4 |
| F5 | 4200 K | S3 | 156 | 170 | XPGDWT-01-0000-00KF5 | | | |
| | | S2 | 148 | 161 | XPGDWT-01-0000-00JF5 | XPGDWT-B1-0000-00JF5 | | |
| | | R5 | 139 | 152 | | XPGDWT-B1-0000-00HF5 | XPGDWT-H1-0000-00HF5 | |
| | | R4 | 130 | 142 | | | XPGDWT-H1-0000-00GF5 | |
| | | R3 | 122 | 133 | | | | XPGDWT-U1-0000-00FF5 |
| | | R2 | 114 | 124 | | | | XPGDWT-U1-0000-00EF5 |
| | | Q5 | 107 | 117 | | | | XPGDWT-U1-0000-00DF5 |
| 5E | 4000 K | S2 | 148 | 161 | | XPGDWT-B1-0000-00J5E | | |
| | | R5 | 139 | 152 | | | XPGDWT-H1-0000-00H5E | |
| | | R4 | 130 | 142 | | | XPGDWT-H1-0000-00G5E | |
| | | R3 | 122 | 133 | | | | XPGDWT-U1-0000-00F5E |
| | | R2 | 114 | 124 | | | | XPGDWT-U1-0000-00E5E |
| | | Q5 | 107 | 117 | | | | XPGDWT-U1-0000-00D5E |

Notes

- Cree LED maintains a tolerance of ±7% on flux and power measurements, ±0.005 on chromaticity (CCx, CCy) measurements and a tolerance of ±2 on CRI measurements. See the Measurements section (page 39).
- XLamp XP-G3 LED order codes specify only a minimum flux bin and not a maximum. Cree LED may ship reels in flux bins higher than the minimum specified by the order code without advance notice. Shipments will always adhere to the chromaticity bin restrictions specified by the order code.
- * Flux values @ 25 °C are calculated and for reference only.

APPENDIX - ORDER CODES NOT FOR NEW DESIGNS - CONTINUED

| Chromaticity | | Minimum Luminous Flux (lm) @ 350 mA | | | Order Codes | | | |
|--------------|--------|-------------------------------------|-------------------|--------------------|----------------------|----------------------|----------------------|----------------------|
| Kit | CCT | Code | Flux (lm) @ 85 °C | Flux (lm) @ 25 °C* | 70 CRI Typical | 70 CRI Minimum | 80 CRI Minimum | 90 CRI Minimum |
| E5 | 4000 K | S3 | 156 | 170 | XPGDWT-01-0000-00KE5 | | | |
| | | S2 | 148 | 161 | XPGDWT-01-0000-00JE5 | XPGDWT-B1-0000-00JE5 | | |
| | | R5 | 139 | 152 | | XPGDWT-B1-0000-00HE5 | XPGDWT-H1-0000-00HE5 | |
| | | R4 | 130 | 142 | | | XPGDWT-H1-0000-00GE5 | |
| | | R3 | 122 | 133 | | | | XPGDWT-U1-0000-00FE5 |
| | | R2 | 114 | 124 | | | | XPGDWT-U1-0000-00EE5 |
| | | Q5 | 107 | 117 | | | | XPGDWT-U1-0000-00DE5 |
| F6 | 3700 K | S2 | 148 | 161 | XPGDWT-01-0000-00JF6 | XPGDWT-B1-0000-00JF6 | | |
| | | R5 | 139 | 152 | XPGDWT-01-0000-00HF6 | XPGDWT-B1-0000-00HF6 | | |
| | | R4 | 130 | 142 | | | XPGDWT-H1-0000-00GF6 | |
| | | R3 | 122 | 133 | | | | |
| | | R2 | 114 | 124 | | | | XPGDWT-U1-0000-00EF6 |
| | | Q5 | 107 | 117 | | | | XPGDWT-U1-0000-00DF6 |
| | | Q4 | 100 | 109 | | | | XPGDWT-U1-0000-00CF6 |
| 6E | 3500 K | S2 | 148 | 161 | | XPGDWT-B1-0000-00JE | | |
| | | R5 | 139 | 152 | | XPGDWT-B1-0000-00HE | | |
| | | R4 | 130 | 142 | | | XPGDWT-H1-0000-00GE | |
| | | R3 | 122 | 133 | | | | |
| | | R2 | 114 | 124 | | | | XPGDWT-U1-0000-00EE |
| | | Q5 | 107 | 117 | | | | XPGDWT-U1-0000-00DE |
| | | Q4 | 100 | 109 | | | | XPGDWT-U1-0000-00CE |
| 6G | 3500 K | R2 | 114 | 124 | | | | XPGDWT-U1-0000-00EG |
| | | Q5 | 107 | 117 | | | | XPGDWT-U1-0000-00DG |
| | | Q4 | 100 | 109 | | | | XPGDWT-U1-0000-00CG |

Notes

- Cree LED maintains a tolerance of ±7% on flux and power measurements, ±0.005 on chromaticity (CCx, CCy) measurements and a tolerance of ±2 on CRI measurements. See the Measurements section (page 39).
- XLamp XP-G3 LED order codes specify only a minimum flux bin and not a maximum. Cree LED may ship reels in flux bins higher than the minimum specified by the order code without advance notice. Shipments will always adhere to the chromaticity bin restrictions specified by the order code.
- * Flux values @ 25 °C are calculated and for reference only.

APPENDIX - ORDER CODES NOT FOR NEW DESIGNS - CONTINUED

| Chromaticity | | Minimum Luminous Flux (lm) @ 350 mA | | | Order Codes | | | |
|--------------|--------|-------------------------------------|-------------------|--------------------|----------------------|----------------------|----------------------|----------------------|
| Kit | CCT | Code | Flux (lm) @ 85 °C | Flux (lm) @ 25 °C* | 70 CRI Typical | 70 CRI Minimum | 80 CRI Minimum | 90 CRI Minimum |
| E6 | 3500 K | S2 | 148 | 161 | XPGDWT-01-0000-00JE6 | XPGDWT-B1-0000-00JE6 | | |
| | | R5 | 139 | 152 | XPGDWT-01-0000-00HE6 | XPGDWT-B1-0000-00HE6 | | |
| | | R4 | 130 | 142 | | | XPGDWT-H1-0000-00GE6 | |
| | | R3 | 122 | 133 | | | | |
| | | R2 | 114 | 124 | | | | XPGDWT-U1-0000-00EE6 |
| | | Q5 | 107 | 117 | | | | XPGDWT-U1-0000-00DE6 |
| | | Q4 | 100 | 109 | | | | XPGDWT-U1-0000-00CE6 |
| F7 | 3200 K | R5 | 139 | 152 | XPGDWT-01-0000-00HF7 | XPGDWT-B1-0000-00HF7 | | |
| | | R4 | 130 | 142 | | | XPGDWT-H1-0000-00GF7 | |
| | | R3 | 122 | 133 | | | | |
| | | R2 | 114 | 124 | | | | XPGDWT-U1-0000-00EF7 |
| | | Q5 | 107 | 117 | | | | XPGDWT-U1-0000-00DF7 |
| | | Q4 | 100 | 109 | | | | XPGDWT-U1-0000-00CF7 |
| 7E | 3000 K | R5 | 139 | 152 | | XPGDWT-B1-0000-00H7E | | |
| | | R4 | 130 | 142 | | | XPGDWT-H1-0000-00G7E | |
| | | R3 | 122 | 133 | | | | |
| | | R2 | 114 | 124 | | | | XPGDWT-U1-0000-00E7E |
| | | Q5 | 107 | 117 | | | | XPGDWT-U1-0000-00D7E |
| | | Q4 | 100 | 109 | | | | XPGDWT-U1-0000-00C7E |
| 7G | 3000 K | R2 | 114 | 124 | | | | XPGDWT-U1-0000-00E7G |
| | | Q5 | 107 | 117 | | | | XPGDWT-U1-0000-00D7G |
| | | Q4 | 100 | 109 | | | | XPGDWT-U1-0000-00C7G |
| E7 | 3000 K | R5 | 139 | 152 | XPGDWT-01-0000-00HE7 | XPGDWT-B1-0000-00HE7 | | |
| | | R4 | 130 | 142 | | | XPGDWT-H1-0000-00GE7 | |
| | | R3 | 122 | 133 | | | | |
| | | R2 | 114 | 124 | | | | XPGDWT-U1-0000-00EE7 |
| | | Q5 | 107 | 117 | | | | XPGDWT-U1-0000-00DE7 |
| | | Q4 | 100 | 109 | | | | XPGDWT-U1-0000-00CE7 |

Notes

- Cree LED maintains a tolerance of ±7% on flux and power measurements, ±0.005 on chromaticity (CCx, CCy) measurements and a tolerance of ±2 on CRI measurements. See the Measurements section (page 39).
- XLamp XP-G3 LED order codes specify only a minimum flux bin and not a maximum. Cree LED may ship reels in flux bins higher than the minimum specified by the order code without advance notice. Shipments will always adhere to the chromaticity bin restrictions specified by the order code.
- * Flux values @ 25 °C are calculated and for reference only.

APPENDIX - ORDER CODES NOT FOR NEW DESIGNS - CONTINUED

| Chromaticity | | Minimum Luminous Flux (lm) @ 350 mA | | | Order Codes | | | |
|--------------|--------|-------------------------------------|-------------------|--------------------|----------------|----------------------|----------------------|----------------------|
| Kit | CCT | Code | Flux (lm) @ 85 °C | Flux (lm) @ 25 °C* | 70 CRI Typical | 70 CRI Minimum | 80 CRI Minimum | 90 CRI Minimum |
| F8 | 2850 K | R3 | 122 | 133 | | | XPGDWT-H1-0000-00FF8 | |
| | | R2 | 114 | 124 | | | | |
| | | Q5 | 107 | 117 | | | | XPGDWT-U1-0000-00DF8 |
| | | Q4 | 100 | 109 | | | | XPGDWT-U1-0000-00CF8 |
| 8E | 2700 K | R3 | 122 | 133 | | | XPGDWT-H1-0000-00F8E | |
| | | R2 | 114 | 124 | | | | |
| | | Q5 | 107 | 117 | | | | XPGDWT-U1-0000-00D8E |
| | | Q4 | 100 | 109 | | | | XPGDWT-U1-0000-00C8E |
| 8G | 2700 K | Q5 | 107 | 117 | | | | XPGDWT-U1-0000-00D8G |
| | | Q4 | 100 | 109 | | | | XPGDWT-U1-0000-00C8G |
| E8 | 2700 K | R3 | 122 | 133 | | | XPGDWT-H1-0000-00FE8 | |
| | | R2 | 114 | 124 | | | | |
| | | Q5 | 107 | 117 | | | | XPGDWT-U1-0000-00DE8 |
| | | Q4 | 100 | 109 | | | | XPGDWT-U1-0000-00CE8 |
| EA | 2200 K | R3 | 122 | 133 | | XPGDWT-B1-0000-00FEA | | |
| | | R2 | 114 | 124 | | XPGDWT-B1-0000-00EEA | | |

Notes

- Cree LED maintains a tolerance of ±7% on flux and power measurements, ±0.005 on chromaticity (CCx, CCy) measurements and a tolerance of ±2 on CRI measurements. See the Measurements section (page 39).
- XLamp XP-G3 LED order codes specify only a minimum flux bin and not a maximum. Cree LED may ship reels in flux bins higher than the minimum specified by the order code without advance notice. Shipments will always adhere to the chromaticity bin restrictions specified by the order code.
- * Flux values @ 25 °C are calculated and for reference only.

APPENDIX - ORDER CODES NOT FOR NEW DESIGNS - CONTINUED

The following order codes are active and valid order codes, but higher performance options are also available. Please see page 10 - page 11 for order codes of XLamp XP-G3 White (S Line) LEDs that could serve as alternatives for the order codes set forth below.

| Chromaticity | | Minimum Luminous Flux (lm) @ 350 mA | | | Order Codes |
|--------------|--------|-------------------------------------|-------------------|--------------------|----------------------|
| Kit | CCT | Code | Flux (lm) @ 85 °C | Flux (lm) @ 25 °C* | 70 CRI Minimum |
| E1 | 6500 K | S3 | 156 | 170 | XPGDWT-BS-0000-00KE1 |
| DV | 6000 K | S3 | 156 | 170 | XPGDWT-BS-0000-00KDV |
| 50 | 6000 K | S3 | 156 | 170 | XPGDWT-BS-0000-00K50 |
| E2 | 5700 K | S3 | 156 | 170 | XPGDWT-BS-0000-00KE2 |
| 2E | 5700 K | S3 | 156 | 170 | XPGDWT-BS-0000-00K2E |
| 3E | 5000 K | S3 | 156 | 170 | XPGDWT-BS-0000-00K3E |
| E3 | 5000 K | S3 | 156 | 170 | XPGDWT-BS-0000-00KE3 |
| 4E | 4500K | S3 | 156 | 170 | XPGDWT-BS-0000-00K4E |
| E4 | 4500 K | S3 | 156 | 170 | XPGDWT-BS-0000-00KE4 |
| 5E | 4000 K | S3 | 156 | 170 | XPGDWT-BS-0000-00K5E |
| E5 | 4000 K | S3 | 156 | 170 | XPGDWT-BS-0000-00KE5 |
| 6E | 3500 K | S3 | 156 | 170 | XPGDWT-BS-0000-00K6E |
| | | S2 | 148 | 161 | XPGDWT-BS-0000-00J6E |
| E6 | 3500 K | S3 | 156 | 170 | XPGDWT-BS-0000-00KE6 |
| | | S2 | 148 | 161 | XPGDWT-BS-0000-00JE6 |
| F7 | 3200K | S3 | 156 | 170 | XPGDWT-BS-0000-00KF7 |
| | | S2 | 148 | 161 | XPGDWT-BS-0000-00JF7 |
| 7E | 3000 K | S3 | 156 | 170 | XPGDWT-BS-0000-00K7E |
| | | S2 | 148 | 161 | XPGDWT-BS-0000-00J7E |
| E7 | 3000 K | S3 | 156 | 170 | XPGDWT-BS-0000-00KE7 |
| | | S2 | 148 | 161 | XPGDWT-BS-0000-00JE7 |

Notes

- Cree LED maintains a tolerance of ±7% on flux and power measurements, ±0.005 on chromaticity (CCx, CCy) measurements and a tolerance of ±2 on CRI measurements. See the Measurements section (page 39).
- XLamp XP-G3 LED order codes specify only a minimum flux bin and not a maximum. Cree LED may ship reels in flux bins higher than the minimum specified by the order code without advance notice. Shipments will always adhere to the chromaticity bin restrictions specified by the order code.
- * Flux values @ 25 °C are calculated and for reference only.

APPENDIX - ORDER CODES NOT FOR NEW DESIGNS - CONTINUED

The following order codes are active and valid order codes, but higher performance options are also available. Please see page 13 - page 14 for order codes of XLamp XP-G3 Color LEDs that could serve as alternatives for the order codes set forth below.

| Color | PWL Kit Code | Peak Wavelength Range | | | | Typical Dominant Wavelength (nm) @ 350 mA, T _j =25 °C | Minimum Radiant Flux (mW) @ 350 mA, | | Calculated Minimum PPF (μmol/s) @ 350 mA, 25 °C | Order Code |
|-----------------------|--------------|-----------------------|----------|---------|----------|---|--|---------------------|--|----------------------|
| | | Minimum | | Maximum | | | Code | Flux (mW) @25 °C | | |
| | | Group | PWL (nm) | Group | PWL (nm) | | | | | |
| Royal Blue (Standard) | 01 | H26 | 440 | H47 | 455 | 451 | E4 | 635 | 2.41 | XPGDRY-L1-0000-00401 |



| Color | PWL Kit Code | Peak Wavelength Range | | | | Typical Dominant Wavelength (nm) @ 350 mA, T _j =25 °C | Minimum Radiant Flux (mW) @ 350 mA, | | Calculated Minimum PPF (μmol/s) @ 350 mA, 25 °C | Order Code |
|--------------------|--------------|-----------------------|----------|---------|----------|---|--|---------------------|--|----------------------|
| | | Minimum | | Maximum | | | Code | Flux (mW) @25 °C | | |
| | | Group | PWL (nm) | Group | PWL (nm) | | | | | |
| Photo Red (S Line) | 01 | P2 | 650 | P5 | 670 | 645 | 32 | 500 | 2.72 | XPGDPR-LS-0000-00F01 |

Notes

- Cree LED maintains a tolerance of ±7% on flux and power measurements, ±0.005 on chromaticity (CCx, CCy) measurements and a tolerance of ±2 on CRI measurements. See the Measurements section (page 39).
- XLamp XP-G3 LED order codes specify only a minimum flux bin and not a maximum. Cree LED may ship reels in flux bins higher than the minimum specified by the order code without advance notice. Shipments will always adhere to the chromaticity bin restrictions specified by the order code.
- * Flux values @ 25 °C are calculated and for reference only.

Looking for pricing, stock, or lifecycle information?

Click below to explore more details on WIN SOURCE:

-  [View XPGDWT-H1-0000-00KE3 on WIN SOURCE](#)
-  [CreeLED, Inc. Information](#)

Optimize Your Supply Chain with WIN SOURCE Solutions

-  Global Sourcing Solution
-  Obsolete Management
-  Cost Control Management
-  Shortage Management
-  Alternative Solution
-  Excess Inventory Management