

XLamp® ML-E LEDs



PRODUCT DESCRIPTION

The XLamp® ML-E LED brings lighting-class reliability and performance to ½-watt LEDs. The XLamp ML-E LED expands Cree LED's lighting-class leadership to LED bulbs and linear and distributed lighting applications. With XLamp LED lighting-class reliability, a wide viewing angle, uniform light output, and industry-leading chromaticity binning in a 3.5-mm X 3.5-mm package, the XLamp ML-E LED continues Cree LED's history of segment-focused product innovation in LEDs for lighting applications.

The XLamp ML-E LED brings high performance and a smooth look to a wide range of lighting applications, including linear lighting, LED light bulbs, fluorescent retrofits and retail-display lighting.

FEATURES

- Available in white (2600 K to 8300 K CCT), 80-, 85- and 90-CRI minimum
- Available in royal blue, blue, green, amber and red
- Available in parallel and series Vf configurations for white and color
- ANSI-compatible sub-bins
- Maximum drive current: 500 mA for parallel white, 167 mA for series white, 350 mA for parallel royal blue, blue, green and red, 250 mA for parallel amber, 120 mA for series blue and green, 65 mA for series amber, 88 mA for series red
- 120° viewing angle for white, 125° viewing angle for color
- Uniform chromaticity profile
- Electrically neutral thermal path
- RoHS and REACH compliant
- UL® recognized component (E349212)



Cree LED / 4001 E. Hwy. 54, Suite 2000 / Durham, NC 27709 USA / +1.919.313.5330 / www.cree-led.com

TABLE OF CONTENTS

Characteristics	3	Performance Groups – Chromaticity.....	32
Characteristics	4	Standard Cool White Kits Plotted on ANSI Standard	
Flux Characteristics - Parallel White	5	Chromaticity Regions	35
Flux Characteristics - Series White	8	Standard Warm and Neutral White Kits Plotted on ANSI	
Flux Characteristics - Parallel Color.....	11	Standard Chromaticity Regions	37
Flux Characteristics - Series Color.....	13	Standard Chromaticity Kits	39
Relative Spectral Power Distribution - White.....	15	Bin and Order Code Formats.....	40
Relative Spectral Power Distribution - Color	15	Reflow Soldering Characteristics.....	41
Relative Luminous Flux vs. Junction Temperature - White	16	Notes	42
Relative Luminous Flux vs. Junction Temperature - Parallel:		Mechanical Dimensions	44
Blue, Green, Amber, Red, Series: Blue, Green, Amber, Red.....	16	Tape and Reel.....	46
Relative Radiant Flux vs. Junction Temperature - Parallel Royal		Packaging.....	47
Blue	17		
Electrical Characteristics - Parallel White.....	18		
Electrical Characteristics - Series White.....	18		
Electrical Characteristics - Parallel Color	19		
Electrical Characteristics - Series Color	19		
Relative Luminous Flux vs. Current - Parallel White.....	20		
Relative Luminous Flux vs. Current - Series White.....	20		
Relative Luminous Flux vs. Current - Parallel Blue, Green,			
Amber, Red	21		
Relative Luminous Flux vs. Current - Series Blue, Green, Amber,			
Red	21		
Relative Radiant Flux vs. Current - Parallel Royal Blue	22		
Typical Spatial Distribution - White	22		
Typical Spatial Distribution - Royal Blue, Blue, Green	23		
Typical Spatial Distribution - Amber, Red	23		
Thermal Design - Parallel White	24		
Thermal Design - Series White	24		
Thermal Design - Parallel Royal Blue	25		
Thermal Design - Parallel Blue	25		
Thermal Design - Series Blue	26		
Thermal Design - Parallel Green.....	26		
Thermal Design - Series Green.....	27		
Thermal Design - Parallel Amber	27		
Thermal Design - Series Amber	28		
Thermal Design - Parallel Red	28		
Thermal Design - Series Red	29		
Performance Groups – Luminous or Radiant Flux	30		
Performance Groups – Dominant Wavelength	31		

CHARACTERISTICS ($T_j = 25\text{ }^\circ\text{C}$)

Characteristics	Unit	Minimum	Typical	Maximum
Thermal resistance, junction to solder point - white ^o	$^\circ\text{C}/\text{W}$		9	
Thermal resistance, junction to solder point - royal blue, blue ^o	$^\circ\text{C}/\text{W}$		8	
Thermal resistance, junction to solder point - green ^o	$^\circ\text{C}/\text{W}$		11	
Thermal resistance, junction to solder point - amber ^o	$^\circ\text{C}/\text{W}$		23	
Thermal resistance, junction to solder point - red ^o	$^\circ\text{C}/\text{W}$		19	
Viewing angle (FWHM) - white	degrees		120	
Viewing angle (FWHM) - royal blue, blue, green, amber, red	degrees		125	
Temperature coefficient of voltage - parallel - white, royal blue	$\text{mV}/^\circ\text{C}$		-3.3	
Temperature coefficient of voltage - parallel - blue	$\text{mV}/^\circ\text{C}$		-2	
Temperature coefficient of voltage - series - white	$\text{mV}/^\circ\text{C}$		-10	
Temperature coefficient of voltage - series - blue	$\text{mV}/^\circ\text{C}$		-5	
Temperature coefficient of voltage - parallel - green	$\text{mV}/^\circ\text{C}$		-3	
Temperature coefficient of voltage - series - green	$\text{mV}/^\circ\text{C}$		-9	
Temperature coefficient of voltage - parallel - amber	$\text{mV}/^\circ\text{C}$		-1	
Temperature coefficient of voltage - series - amber	$\text{mV}/^\circ\text{C}$		-3.2	
Temperature coefficient of voltage - parallel - red	$\text{mV}/^\circ\text{C}$		-1.8	
Temperature coefficient of voltage - series - red	$\text{mV}/^\circ\text{C}$		-5.4	
ESD classification (HBM per Mil-Std-883D)			Class 3B	
DC forward current - parallel - white	mA			500
DC forward current - series - white	mA			167
DC forward current - parallel - royal blue, blue, green, red	mA			350
DC forward current - series - blue, green	mA			120
DC forward current - parallel - amber	mA			250
DC forward current - series - amber	mA			65
DC forward current - series - red	mA			88
Reverse voltage	V			1

CHARACTERISTICS ($T_j = 25\text{ }^\circ\text{C}$) - CONTINUED

Characteristics	Unit	Minimum	Typical	Maximum
Forward voltage (@ 150 mA) - parallel - white, royal blue	V		3.2	3.4
Forward voltage (@ 50 mA) - series - white	V		9.6	10.2
Forward voltage (@ 150 mA) - parallel - blue	V		3.0	
Forward voltage (@ 50 mA) - series - blue	V		8.9	
Forward voltage (@ 150 mA) - parallel - green	V		2.8	
Forward voltage (@ 50 mA) - series - green	V		8.5	
Forward voltage (@ 150 mA) - parallel - amber, red	V		2.4	
Forward voltage (@ 37.5 mA) - series - amber, red	V		9.6	
LED junction temperature	$^\circ\text{C}$			150

Note:

- ◇ Thermal resistance measurement was performed per the JEDEC JESD51-14 standard. See the [Thermal Resistance Measurement application note](#) for more details.

FLUX CHARACTERISTICS - PARALLEL WHITE (T_j = 25 °C)

The following table provides order codes for XLamp ML-E LEDs. For a complete description of the order-code nomenclature, please consult the Bin and Order Code Formats section (page 40).

Chromaticity		Minimum Luminous Flux (lm) @ 150 mA		Calculated Minimum Luminous Flux (lm)*		Order Codes	
Kit	CCT	Code	Flux	350 mA	500 mA	75 CRI Typical	80 CRI Minimum
DT	7000 K	N3	56.8	114.1	146.0	MLEAWT-A1-0000-0005DT	
		N2	51.7	104.8	132.9	MLEAWT-A1-0000-0004DT	
		M3	45.7	92.6	117.4	MLEAWT-A1-0000-0003DT	
E0	7000 K	N3	56.8	114.1	146.0	MLEAWT-A1-0000-0005E0	
		N2	51.7	104.8	132.9	MLEAWT-A1-0000-0004E0	
		M3	45.7	92.6	117.4	MLEAWT-A1-0000-0003E0	
51	6500 K	N3	56.8	114.1	146.0	MLEAWT-A1-0000-000551	
		N2	51.7	104.8	132.9	MLEAWT-A1-0000-000451	
		M3	45.7	92.6	117.4	MLEAWT-A1-0000-000351	
E1	6500 K	N3	56.8	114.1	146.0	MLEAWT-A1-0000-0005E1	
		N2	51.7	104.8	132.9	MLEAWT-A1-0000-0004E1	
		M3	45.7	92.6	117.4	MLEAWT-A1-0000-0003E1	
50	6200 K	N3	56.8	114.1	146.0	MLEAWT-A1-0000-000550	
		N2	51.7	104.8	132.9	MLEAWT-A1-0000-000450	
		M3	45.7	92.6	117.4	MLEAWT-A1-0000-000350	
DV	6000 K	N3	56.8	114.1	146.0	MLEAWT-A1-0000-0005DV	
		N2	51.7	104.8	132.9	MLEAWT-A1-0000-0004DV	
		M3	45.7	92.6	117.4	MLEAWT-A1-0000-0003DV	
E2	5750 K	N3	56.8	114.1	146.0	MLEAWT-A1-0000-0005E2	
		N2	51.7	104.8	132.9	MLEAWT-A1-0000-0004E2	
		M3	45.7	92.6	117.4	MLEAWT-A1-0000-0003E2	
DY	5500 K	N3	56.8	114.1	146.0	MLEAWT-A1-0000-0005DY	
		N2	51.7	104.8	132.9	MLEAWT-A1-0000-0004DY	
		M3	45.7	92.6	117.4	MLEAWT-A1-0000-0003DY	
DZ	5000 K	N3	56.8	114.1	146.0	MLEAWT-A1-0000-0005DZ	
		N2	51.7	104.8	132.9	MLEAWT-A1-0000-0004DZ	
		M3	45.7	92.6	117.4	MLEAWT-A1-0000-0003DZ	

Notes:

- Cree LED maintains a tolerance of ±7% on flux and power measurements, ±0.005 on chromaticity (CCx, CCy) measurements and ±2 on CRI measurements. See the Measurements section (page 42).
- XLamp ML-E LED order codes specify only a minimum flux bin and not a maximum. Cree LED may ship reels in flux bins higher than the minimum specified by the order code without advance notice. Shipments will always adhere to the chromaticity or DWL bin restrictions specified by the order code.
- Minimum CRI for 80-CRI White is 80.
- Minimum CRI for 85-CRI White is 85.
- Minimum CRI for 90-CRI White is 90
- * Calculated flux values are for reference only.

FLUX CHARACTERISTICS - PARALLEL WHITE (T_j = 25 °C) - CONTINUED

Chromaticity		Minimum Luminous Flux (lm) @ 150 mA		Calculated Minimum Luminous Flux (lm)*		Order Codes	
Kit	CCT	Code	Flux	350 mA	500 mA	75 CRI Typical	80 CRI Minimum
E3	5000 K	N3	56.8	114.1	146.0	MLEAWT-A1-0000-0005E3	
		N2	51.7	104.8	132.9	MLEAWT-A1-0000-0004E3	MLEAWT-H1-0000-0004E3
		M3	45.7	92.6	117.4	MLEAWT-A1-0000-0003E3	MLEAWT-H1-0000-0003E3
		M2	39.8	80.7	102.3	MLEAWT-A1-0000-0002E3	MLEAWT-H1-0000-0002E3
F4	4750 K	N3	56.8	114.1	146.0	MLEAWT-A1-0000-0005F4	
		N2	51.7	104.8	132.9	MLEAWT-A1-0000-0004F4	
		M3	45.7	92.6	117.4	MLEAWT-A1-0000-0003F4	
		M2	39.8	80.7	102.3	MLEAWT-A1-0000-0002F4	
E4	4500 K	N3	56.8	114.1	146.0	MLEAWT-A1-0000-0005E4	
		N2	51.7	104.8	132.9	MLEAWT-A1-0000-0004E4	
		M3	45.7	92.6	117.4	MLEAWT-A1-0000-0003E4	
		M2	39.8	80.7	102.3	MLEAWT-A1-0000-0002E4	

Chromaticity		Minimum Luminous Flux (lm) @ 150 mA		Calculated Minimum Luminous Flux (lm)*		Order Codes			
Kit	CCT	Code	Flux	350 mA	500 mA	80 CRI Typical	80 CRI Minimum	85 CRI Minimum	90 CRI Minimum
F5	4250 K	N2	51.7	104.8	132.9	MLEAWT-A1-0000-0004F5			
		M3	45.7	92.6	117.4	MLEAWT-A1-0000-0003F5			
		M2	39.8	80.7	102.3	MLEAWT-A1-0000-0002F5			
E5	4000 K	N2	51.7	104.8	132.9	MLEAWT-A1-0000-0004E5			
		M3	45.7	92.6	117.4	MLEAWT-A1-0000-0003E5	MLEAWT-H1-0000-0003E5	MLEAWT-P1-0000-0003E5	
		M2	39.8	80.7	102.3	MLEAWT-A1-0000-0002E5	MLEAWT-H1-0000-0002E5	MLEAWT-P1-0000-0002E5	MLEAWT-U1-0000-0002E5
		K3	35.2	71.4	90.5		MLEAWT-H1-0000-0001E5	MLEAWT-P1-0000-0001E5	MLEAWT-U1-0000-0001E5
Z5	4000 K	N2	51.7	104.8	132.9	MLEAWT-A1-0000-0004Z5			
		M3	45.7	92.6	117.4	MLEAWT-A1-0000-0003Z5	MLEAWT-H1-0000-0003Z5	MLEAWT-P1-0000-0003Z5	
		M2	39.8	80.7	102.3	MLEAWT-A1-0000-0002Z5	MLEAWT-H1-0000-0002Z5	MLEAWT-P1-0000-0002Z5	MLEAWT-U1-0000-0002Z5
		K3	35.2	71.4	90.5		MLEAWT-H1-0000-0001Z5	MLEAWT-P1-0000-0001Z5	MLEAWT-U1-0000-0001Z5
F6	3750 K	M3	45.7	92.6	117.4	MLEAWT-A1-0000-0003F6			
		M2	39.8	80.7	102.3	MLEAWT-A1-0000-0002F6	MLEAWT-H1-0000-0002F6	MLEAWT-P1-0000-0002F6	MLEAWT-U1-0000-0002F6
		K3	35.2	71.4	90.5		MLEAWT-H1-0000-0001F6	MLEAWT-P1-0000-0001F6	MLEAWT-U1-0000-0001F6

Notes:

- Cree LED maintains a tolerance of ±7% on flux and power measurements, ±0.005 on chromaticity (CCx, CCy) measurements and ±2 on CRI measurements. See the Measurements section (page 42).
- XLamp ML-E LED order codes specify only a minimum flux bin and not a maximum. Cree LED may ship reels in flux bins higher than the minimum specified by the order code without advance notice. Shipments will always adhere to the chromaticity or DWL bin restrictions specified by the order code.
- Minimum CRI for 80-CRI White is 80.
- Minimum CRI for 85-CRI White is 85.
- Minimum CRI for 90-CRI White is 90
- * Calculated flux values are for reference only.

FLUX CHARACTERISTICS - PARALLEL WHITE (T_j = 25 °C) - CONTINUED

Chromaticity		Minimum Luminous Flux (lm) @ 150 mA		Calculated Minimum Luminous Flux (lm)*		Order Codes			
Kit	CCT	Code	Flux	350 mA	500 mA	80 CRI Typical	80 CRI Minimum	85 CRI Minimum	90 CRI Minimum
E6	3500 K	M3	45.7	92.6	117.4	MLEAWT-A1-0000-0003E6			
		M2	39.8	80.7	102.3	MLEAWT-A1-0000-0002E6	MLEAWT-H1-0000-0002E6	MLEAWT-P1-0000-0002E6	MLEAWT-U1-0000-0002E6
		K3	35.2	71.4	90.5		MLEAWT-H1-0000-0001E6	MLEAWT-P1-0000-0001E6	MLEAWT-U1-0000-0001E6
Z6	3500 K	M3	45.7	92.6	117.4	MLEAWT-A1-0000-0003Z6			
		M2	39.8	80.7	102.3	MLEAWT-A1-0000-0002Z6	MLEAWT-H1-0000-0002Z6	MLEAWT-P1-0000-0002Z6	MLEAWT-U1-0000-0002Z6
		K3	35.2	71.4	90.5		MLEAWT-H1-0000-0001Z6	MLEAWT-P1-0000-0001Z6	MLEAWT-U1-0000-0001Z6
F7	3250 K	M3	45.7	92.6	117.4	MLEAWT-A1-0000-0003F7			
		M2	39.8	80.7	102.3	MLEAWT-A1-0000-0002F7	MLEAWT-H1-0000-0002F7	MLEAWT-P1-0000-0002F7	MLEAWT-U1-0000-0002F7
		K3	35.2	71.4	90.5		MLEAWT-H1-0000-0001F7	MLEAWT-P1-0000-0001F7	MLEAWT-U1-0000-0001F7
		K2	30.6	62.0	78.6		MLEAWT-H1-0000-0000F7	MLEAWT-P1-0000-0000F7	MLEAWT-U1-0000-0000F7
E7	3000 K	M3	45.7	92.6	117.4	MLEAWT-A1-0000-0003E7			
		M2	39.8	80.7	102.3	MLEAWT-A1-0000-0002E7	MLEAWT-H1-0000-0002E7	MLEAWT-P1-0000-0002E7	MLEAWT-U1-0000-0002E7
		K3	35.2	71.4	90.5		MLEAWT-H1-0000-0001E7	MLEAWT-P1-0000-0001E7	MLEAWT-U1-0000-0001E7
		K2	30.6	62.0	78.6		MLEAWT-H1-0000-0000E7	MLEAWT-P1-0000-0000E7	MLEAWT-U1-0000-0000E7
Z7	3000 K	M3	45.7	92.6	117.4	MLEAWT-A1-0000-0003Z7			
		M2	39.8	80.7	102.3	MLEAWT-A1-0000-0002Z7	MLEAWT-H1-0000-0002Z7	MLEAWT-P1-0000-0002Z7	MLEAWT-U1-0000-0002Z7
		K3	35.2	71.4	90.5		MLEAWT-H1-0000-0001Z7	MLEAWT-P1-0000-0001Z7	MLEAWT-U1-0000-0001Z7
		K2	30.6	62.0	78.6		MLEAWT-H1-0000-0000Z7	MLEAWT-P1-0000-0000Z7	MLEAWT-U1-0000-0000Z7
F8	2850 K	M2	39.8	80.7	102.3	MLEAWT-A1-0000-0002F8	MLEAWT-H1-0000-0002F8		
		K3	35.2	71.4	90.5		MLEAWT-H1-0000-0001F8	MLEAWT-P1-0000-0001F8	MLEAWT-U1-0000-0001F8
		K2	30.6	62.0	78.6		MLEAWT-H1-0000-0000F8	MLEAWT-P1-0000-0000F8	MLEAWT-U1-0000-0000F8
E8	2700 K	M3	45.7	92.6	117.4		MLEAWT-H1-0000-0003E8		
		M2	39.8	80.7	102.3	MLEAWT-A1-0000-0002E8	MLEAWT-H1-0000-0002E8		
		K3	35.2	71.4	90.5		MLEAWT-H1-0000-0001E8	MLEAWT-P1-0000-0001E8	MLEAWT-U1-0000-0001E8
		K2	30.6	62.0	78.6		MLEAWT-H1-0000-0000E8	MLEAWT-P1-0000-0000E8	MLEAWT-U1-0000-0000E8
Z8	2700 K	M2	39.8	80.7	102.3	MLEAWT-A1-0000-0002Z8			
		K3	35.2	71.4	90.5		MLEAWT-H1-0000-0001Z8	MLEAWT-P1-0000-0001Z8	MLEAWT-U1-0000-0001Z8
		K2	30.6	62.0	78.6		MLEAWT-H1-0000-0000Z8	MLEAWT-P1-0000-0000Z8	MLEAWT-U1-0000-0000Z8

Notes:

- Cree LED maintains a tolerance of ±7% on flux and power measurements, ±0.005 on chromaticity (CCx, CCy) measurements and ±2 on CRI measurements. See the Measurements section (page 42).
- XLamp ML-E LED order codes specify only a minimum flux bin and not a maximum. Cree LED may ship reels in flux bins higher than the minimum specified by the order code without advance notice. Shipments will always adhere to the chromaticity or DWL bin restrictions specified by the order code.
- Minimum CRI for 80-CRI White is 80.
- Minimum CRI for 85-CRI White is 85.
- Minimum CRI for 90-CRI White is 90
- * Calculated flux values are for reference only.

FLUX CHARACTERISTICS - SERIES WHITE (T_J = 25 °C)

The following table provides order codes for XLamp ML-E LEDs. For a complete description of the order-code nomenclature, please consult the Bin and Order Code Formats section (page 40).

Chromaticity		Minimum Luminous Flux (lm) @ 50 mA		Calculated Minimum Luminous Flux (lm)*		Order Codes	
Kit	CCT	Code	Flux	117 mA	166 mA	75 CRI Typical	80 CRI Minimum
DT	7000 K	N2	51.7	104.8	132.9	MLESWT-A1-0000-0004DT	
		M3	45.7	92.6	117.4	MLESWT-A1-0000-0003DT	
E0	7000 K	N2	51.7	104.8	132.9	MLESWT-A1-0000-0004E0	
		M3	45.7	92.6	117.4	MLESWT-A1-0000-0003E0	
51	6500 K	N2	51.7	104.8	132.9	MLESWT-A1-0000-000451	
		M3	45.7	92.6	117.4	MLESWT-A1-0000-000351	
E1	6500 K	N2	51.7	104.8	132.9	MLESWT-A1-0000-0004E1	
		M3	45.7	92.6	117.4	MLESWT-A1-0000-0003E1	
50	6200 K	N2	51.7	104.8	132.9	MLESWT-A1-0000-000450	
		M3	45.7	92.6	117.4	MLESWT-A1-0000-000350	
DV	6000 K	N2	51.7	104.8	132.9	MLESWT-A1-0000-0004DV	
		M3	45.7	92.6	117.4	MLESWT-A1-0000-0003DV	
E2	5750 K	N2	51.7	104.8	132.9	MLESWT-A1-0000-0004E2	
		M3	45.7	92.6	117.4	MLESWT-A1-0000-0003E2	
DY	5500 K	N2	51.7	104.8	132.9	MLESWT-A1-0000-0004DY	
		M3	45.7	92.6	117.4	MLESWT-A1-0000-0003DY	
DZ	5000 K	N2	51.7	104.8	132.9	MLESWT-A1-0000-0004DZ	
		M3	45.7	92.6	117.4	MLESWT-A1-0000-0003DZ	
E3	5000 K	N2	51.7	104.8	132.9	MLESWT-A1-0000-0004E3	MLESWT-H1-0000-0004E3
		M3	45.7	92.6	117.4	MLESWT-A1-0000-0003E3	MLESWT-H1-0000-0003E3
		M2	39.8	80.7	102.3	MLESWT-A1-0000-0002E3	MLESWT-H1-0000-0002E3
F4	4750 K	N2	51.7	104.8	132.9	MLESWT-A1-0000-0004F4	
		M3	45.7	92.6	117.4	MLESWT-A1-0000-0003F4	
		M2	39.8	80.7	102.3	MLESWT-A1-0000-0002F4	
E4	4500 K	N2	51.7	104.8	132.9	MLESWT-A1-0000-0004E4	
		M3	45.7	92.6	117.4	MLESWT-A1-0000-0003E4	
		M2	39.8	80.7	102.3	MLESWT-A1-0000-0002E4	

Notes:

- Cree LED maintains a tolerance of ±7% on flux and power measurements, ±0.005 on chromaticity (CCx, CCy) measurements and ±2 on CRI measurements. See the Measurements section (page 42).
- XLamp ML-E LED order codes specify only a minimum flux bin and not a maximum. Cree LED may ship reels in flux bins higher than the minimum specified by the order code without advance notice. Shipments will always adhere to the chromaticity or DWL bin restrictions specified by the order code.
- Minimum CRI for 80-CRI White is 80.
- Minimum CRI for 85-CRI White is 85.
- Minimum CRI for 90-CRI White is 90
- * Calculated flux values are for reference only.

FLUX CHARACTERISTICS - SERIES WHITE (T_J = 25 °C) - CONTINUED

Chromaticity		Minimum Luminous Flux (lm) @ 50 mA		Calculated Minimum Luminous Flux (lm)*		Order Codes			
Kit	CCT	Code	Flux	117 mA	166 mA	80 CRI Typical	80 CRI Minimum	85 CRI Minimum	90 CRI Minimum
F5	4250 K	N2	51.7	104.8	132.9	MLESWT-A1-0000-0004F5			
		M3	45.7	92.6	117.4	MLESWT-A1-0000-0003F5			
		M2	39.8	80.7	102.3	MLESWT-A1-0000-0002F5			
E5	4000 K	N2	51.7	104.8	132.9	MLESWT-A1-0000-0004E5			
		M3	45.7	92.6	117.4	MLESWT-A1-0000-0003E5	MLESWT-H1-0000-0003E5	MLESWT-P1-0000-0003E5	
		M2	39.8	80.7	102.3	MLESWT-A1-0000-0002E5	MLESWT-H1-0000-0002E5	MLESWT-P1-0000-0002E5	MLESWT-U1-0000-0002E5
		K3	35.2	71.4	90.5		MLESWT-H1-0000-0001E5	MLESWT-P1-0000-0001E5	MLESWT-U1-0000-0001E5
Z5	4000 K	N2	51.7	104.8	132.9	MLESWT-A1-0000-0004Z5			
		M3	45.7	92.6	117.4	MLESWT-A1-0000-0003Z5	MLESWT-H1-0000-0003Z5	MLESWT-P1-0000-0003Z5	
		M2	39.8	80.7	102.3	MLESWT-A1-0000-0002Z5	MLESWT-H1-0000-0002Z5	MLESWT-P1-0000-0002Z5	MLESWT-U1-0000-0002Z5
		K3	35.2	71.4	90.5		MLESWT-H1-0000-0001Z5	MLESWT-P1-0000-0001Z5	MLESWT-U1-0000-0001Z5
F6	3750 K	M3	45.7	92.6	117.4	MLESWT-A1-0000-0003F6			
		M2	39.8	80.7	102.3	MLESWT-A1-0000-0002F6	MLESWT-H1-0000-0002F6	MLESWT-P1-0000-0002F6	MLESWT-U1-0000-0002F6
		K3	35.2	71.4	90.5		MLESWT-H1-0000-0001F6	MLESWT-P1-0000-0001F6	MLESWT-U1-0000-0001F6
E6	3500 K	M3	45.7	92.6	117.4	MLESWT-A1-0000-0003E6			
		M2	39.8	80.7	102.3	MLESWT-A1-0000-0002E6	MLESWT-H1-0000-0002E6	MLESWT-P1-0000-0002E6	MLESWT-U1-0000-0002E6
		K3	35.2	71.4	90.5		MLESWT-H1-0000-0001E6	MLESWT-P1-0000-0001E6	MLESWT-U1-0000-0001E6
Z6	3500 K	M3	45.7	92.6	117.4	MLESWT-A1-0000-0003Z6			
		M2	39.8	80.7	102.3	MLESWT-A1-0000-0002Z6	MLESWT-H1-0000-0002Z6	MLESWT-P1-0000-0002Z6	MLESWT-U1-0000-0002Z6
		K3	35.2	71.4	90.5		MLESWT-H1-0000-0001Z6	MLESWT-P1-0000-0001Z6	MLESWT-U1-0000-0001Z6
F7	3250 K	M3	45.7	92.6	117.4	MLESWT-A1-0000-0003F7			
		M2	39.8	80.7	102.3	MLESWT-A1-0000-0002F7	MLESWT-H1-0000-0002F7	MLESWT-P1-0000-0002F7	MLESWT-U1-0000-0002F7
		K3	35.2	71.4	90.5		MLESWT-H1-0000-0001F7	MLESWT-P1-0000-0001F7	MLESWT-U1-0000-0001F7
		K2	30.6	62.0	78.6			MLESWT-P1-0000-0000F7	MLESWT-U1-0000-0000F7
E7	3000 K	M3	45.7	92.6	117.4	MLESWT-A1-0000-0003E7			
		M2	39.8	80.7	102.3	MLESWT-A1-0000-0002E7	MLESWT-H1-0000-0002E7	MLESWT-P1-0000-0002E7	MLESWT-U1-0000-0002E7
		K3	35.2	71.4	90.5		MLESWT-H1-0000-0001E7	MLESWT-P1-0000-0001E7	MLESWT-U1-0000-0001E7
		K2	30.6	62.0	78.6			MLESWT-P1-0000-0000E7	MLESWT-U1-0000-0000E7
Z7	3000 K	M3	45.7	92.6	117.4	MLESWT-A1-0000-0003Z7			
		M2	39.8	80.7	102.3	MLESWT-A1-0000-0002Z7	MLESWT-H1-0000-0002Z7	MLESWT-P1-0000-0002Z7	MLESWT-U1-0000-0002Z7
		K3	35.2	71.4	90.5		MLESWT-H1-0000-0001Z7	MLESWT-P1-0000-0001Z7	MLESWT-U1-0000-0001Z7
		K2	30.6	62.0	78.6			MLESWT-P1-0000-0000Z7	MLESWT-U1-0000-0000Z7

Notes:

- Cree LED maintains a tolerance of ±7% on flux and power measurements, ±0.005 on chromaticity (CCx, CCy) measurements and ±2 on CRI measurements. See the Measurements section (page 42).
- XLamp ML-E LED order codes specify only a minimum flux bin and not a maximum. Cree LED may ship reels in flux bins higher than the minimum specified by the order code without advance notice. Shipments will always adhere to the chromaticity or DWL bin restrictions specified by the order code.
- Minimum CRI for 80-CRI White is 80.
- Minimum CRI for 85-CRI White is 85.
- Minimum CRI for 90-CRI White is 90
- * Calculated flux values are for reference only.

FLUX CHARACTERISTICS - SERIES WHITE (T_J = 25 °C) - CONTINUED

Chromaticity		Minimum Luminous Flux (lm) @ 50 mA		Calculated Minimum Luminous Flux (lm)*		Order Codes			
Kit	CCT	Code	Flux	117 mA	166 mA	80 CRI Typical	80 CRI Minimum	85 CRI Minimum	90 CRI Minimum
F8	2850 K	M2	39.8	80.7	102.3	MLESWT-A1-0000-0002F8			
		K3	35.2	71.4	90.5		MLESWT-H1-0000-0001F8	MLESWT-P1-0000-0001F8	MLESWT-U1-0000-0001F8
		K2	30.6	62.0	78.6			MLESWT-P1-0000-0000F8	MLESWT-U1-0000-0000F8
E8	2700 K	M2	39.8	80.7	102.3	MLESWT-A1-0000-0002E8			
		K3	35.2	71.4	90.5		MLESWT-H1-0000-0001E8	MLESWT-P1-0000-0001E8	MLESWT-U1-0000-0001E8
		K2	30.6	62.0	78.6			MLESWT-P1-0000-0000E8	MLESWT-U1-0000-0000E8
Z8	2700 K	M2	39.8	80.7	102.3	MLESWT-A1-0000-0002Z8			
		K3	35.2	71.4	90.5		MLESWT-H1-0000-0001Z8	MLESWT-P1-0000-0001Z8	MLESWT-U1-0000-0001Z8
		K2	30.6	62.0	78.6			MLESWT-P1-0000-0000Z8	MLESWT-U1-0000-0000Z8

Notes:

- Cree LED maintains a tolerance of ±7% on flux and power measurements, ±0.005 on chromaticity (CCx, CCy) measurements and ±2 on CRI measurements. See the Measurements section (page 42).
- XLamp ML-E LED order codes specify only a minimum flux bin and not a maximum. Cree LED may ship reels in flux bins higher than the minimum specified by the order code without advance notice. Shipments will always adhere to the chromaticity or DWL bin restrictions specified by the order code.
- Minimum CRI for 80-CRI White is 80.
- Minimum CRI for 85-CRI White is 85.
- Minimum CRI for 90-CRI White is 90
- * Calculated flux values are for reference only.

FLUX CHARACTERISTICS - PARALLEL COLOR (T_J = 25 °C)

The following table provides order codes for XLamp ML-E color LEDs. For a complete description of the order-code nomenclature, please consult the Bin and Order Code Formats section (page 40).

Royal Blue		Minimum Radiant Flux (lm) @ 150 mA		Order Codes
Kit	Dominant Wavelength (nm)	Code	Flux (mW)	
01	450 - 465	10	175	MLEROY-A1-0000-000501
		9	147	MLEROY-A1-0000-000401
02	450 - 460	10	175	MLEROY-A1-0000-000502
		9	147	MLEROY-A1-0000-000402
03	455 - 465	10	175	MLEROY-A1-0000-000503
		9	147	MLEROY-A1-0000-000403
04	450-455	10	175	MLEROY-A1-0000-000504
		9	147	MLEROY-A1-0000-000404
05	455-460	10	175	MLEROY-A1-0000-000505
		9	147	MLEROY-A1-0000-000405
06	460-465	10	175	MLEROY-A1-0000-000506
		9	147	MLEROY-A1-0000-000406

Blue		Minimum Luminous Flux (lm) @ 150 mA		Order Codes
Kit	Dominant Wavelength (nm)	Code	Flux (lm)	
01	465 - 485	G2	13.9	MLEBLU-A1-0000-000U01
		F2	10.7	MLEBLU-A1-0000-000T01
02	465 - 480	G2	13.9	MLEBLU-A1-0000-000U02
		F2	10.7	MLEBLU-A1-0000-000T02
05	470 - 480	G2	13.9	MLEBLU-A1-0000-000U05
		F2	10.7	MLEBLU-A1-0000-000T05

- Note:
- Cree LED maintains a tolerance of ±7% on flux and power measurements, ±0.005 on chromaticity (CCx, CCy) measurements and ±2 on CRI measurements and ±1 nm on dominant wavelength measurements. See the Measurements section (page 42).
 - XLamp ML-E LED order codes specify only a minimum flux bin and not a maximum. Cree LED may ship reels in flux bins higher than the minimum specified by the order code without advance notice. Shipments will always adhere to the chromaticity or DWL bin restrictions specified by the order code.

FLUX CHARACTERISTICS - PARALLEL COLOR (T_j = 25 °C) - CONTINUED

Green		Minimum Luminous Flux (lm) @ 150 mA		Order Codes
Kit	Dominant Wavelength (nm)	Code	Flux (lm)	
01	520 - 535	K3	35.2	MLEGRN-A1-0000-000101
		K2	30.6	MLEGRN-A1-0000-000001
		J3	26.8	MLEGRN-A1-0000-000X01
02	520 - 530	K3	35.2	MLEGRN-A1-0000-000102
		K2	30.6	MLEGRN-A1-0000-000002
		J3	26.8	MLEGRN-A1-0000-000X02
03	525 - 535	K3	35.2	MLEGRN-A1-0000-000103
		K2	30.6	MLEGRN-A1-0000-000003
		J3	26.8	MLEGRN-A1-0000-000X03

Amber		Minimum Luminous Flux (lm) @ 150 mA		Order Codes
Kit	Dominant Wavelength (nm)	Code	Flux (lm)	
01	585 - 595	J3	26.8	MLEAMB-A1-0000-000X01
		J2	23.5	MLEAMB-A1-0000-000W01

Red		Minimum Luminous Flux (lm) @ 150 mA		Order Codes
Kit	Dominant Wavelength (nm)	Code	Flux (lm)	
01	620 - 630	J2	23.5	MLERED-A1-0000-000W01
		H2	18.1	MLERED-A1-0000-000V01
02	620 - 625	J2	23.5	MLERED-A1-0000-000W02
		H2	18.1	MLERED-A1-0000-000V02
03	625 - 630	J2	23.5	MLERED-A1-0000-000W03
		H2	18.1	MLERED-A1-0000-000V03

- Note:**
- Cree LED maintains a tolerance of ±7% on flux and power measurements, ±0.005 on chromaticity (CCx, CCy) measurements and ±2 on CRI measurements and ±1 nm on dominant wavelength measurements. See the Measurements section (page 42).
 - XLamp ML-E LED order codes specify only a minimum flux bin and not a maximum. Cree LED may ship reels in flux bins higher than the minimum specified by the order code without advance notice. Shipments will always adhere to the chromaticity or DWL bin restrictions specified by the order code.

FLUX CHARACTERISTICS - SERIES COLOR ($T_j = 25\text{ }^\circ\text{C}$)

The following table provides order codes for XLamp ML-E color LEDs. For a complete description of the order-code nomenclature, please consult the Bin and Order Code Formats section (page 40).

Blue		Minimum Luminous Flux (lm) @ 50 mA		Order Codes
Kit	Dominant Wavelength (nm)	Code	Flux (lm)	
01	465 - 485	G2	13.9	MLESBL-A1-0000-000U01
		F2	10.7	MLESBL-A1-0000-000T01
02	465 - 480	G2	13.9	MLESBL-A1-0000-000U02
		F2	10.7	MLESBL-A1-0000-000T02
05	470 - 480	G2	13.9	MLESBL-A1-0000-000U05
		F2	10.7	MLESBL-A1-0000-000T05

Green		Minimum Luminous Flux (lm) @ 50 mA		Order Codes
Kit	Dominant Wavelength (nm)	Code	Flux (lm)	
01	520 - 535	K3	35.2	MLESGN-A1-0000-000101
		K2	30.6	MLESGN-A1-0000-000001
		J3	26.8	MLESGN-A1-0000-000X01
02	520 - 530	K3	35.2	MLESGN-A1-0000-000102
		K2	30.6	MLESGN-A1-0000-000002
		J3	26.8	MLESGN-A1-0000-000X02
03	525 - 535	K3	35.2	MLESGN-A1-0000-000103
		K2	30.6	MLESGN-A1-0000-000003
		J3	26.8	MLESGN-A1-0000-000X03

Amber		Minimum Luminous Flux (lm) @ 37.5 mA		Order Codes
Kit	Dominant Wavelength (nm)	Code	Flux (lm)	
01	585 - 595	J3	26.8	MLESAM-A1-0000-000X01
		J2	23.5	MLESAM-A1-0000-000W01

Note:

- Cree LED maintains a tolerance of $\pm 7\%$ on flux and power measurements, ± 0.005 on chromaticity (CCx, CCy) measurements and ± 2 on CRI measurements and ± 1 nm on dominant wavelength measurements. See the Measurements section (page 42).
- XLamp ML-E LED order codes specify only a minimum flux bin and not a maximum. Cree LED may ship reels in flux bins higher than the minimum specified by the order code without advance notice. Shipments will always adhere to the chromaticity or DWL bin restrictions specified by the order code.

FLUX CHARACTERISTICS - SERIES COLOR ($T_J = 25\text{ }^\circ\text{C}$) - CONTINUED

Red		Minimum Luminous Flux (lm) @ 37.5 mA		Order Codes
Kit	Dominant Wavelength (nm)	Code	Flux (lm)	
01	620 - 630	J2	23.5	MLESRD-A1-0000-000W01
		H2	18.1	MLESRD-A1-0000-000V01
02	620 - 625	J2	23.5	MLESRD-A1-0000-000W02
		H2	18.1	MLESRD-A1-0000-000V02
03	625-630	J2	23.5	MLESRD-A1-0000-000W03
		H2	18.1	MLESRD-A1-0000-000V03

Note:

- Cree LED maintains a tolerance of $\pm 7\%$ on flux and power measurements, ± 0.005 on chromaticity (CCx, CCy) measurements and ± 2 on CRI measurements and ± 1 nm on dominant wavelength measurements. See the Measurements section (page 42).
- XLamp ML-E LED order codes specify only a minimum flux bin and not a maximum. Cree LED may ship reels in flux bins higher than the minimum specified by the order code without advance notice. Shipments will always adhere to the chromaticity or DWL bin restrictions specified by the order code.

RELATIVE SPECTRAL POWER DISTRIBUTION - WHITE

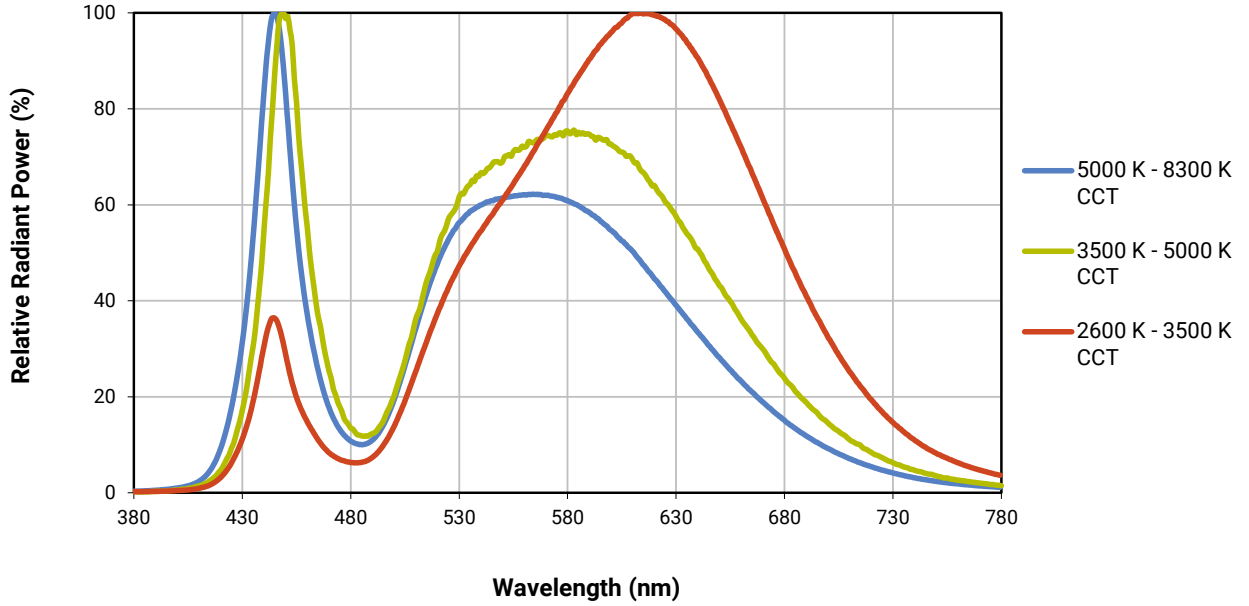

RELATIVE SPECTRAL POWER DISTRIBUTION - COLOR

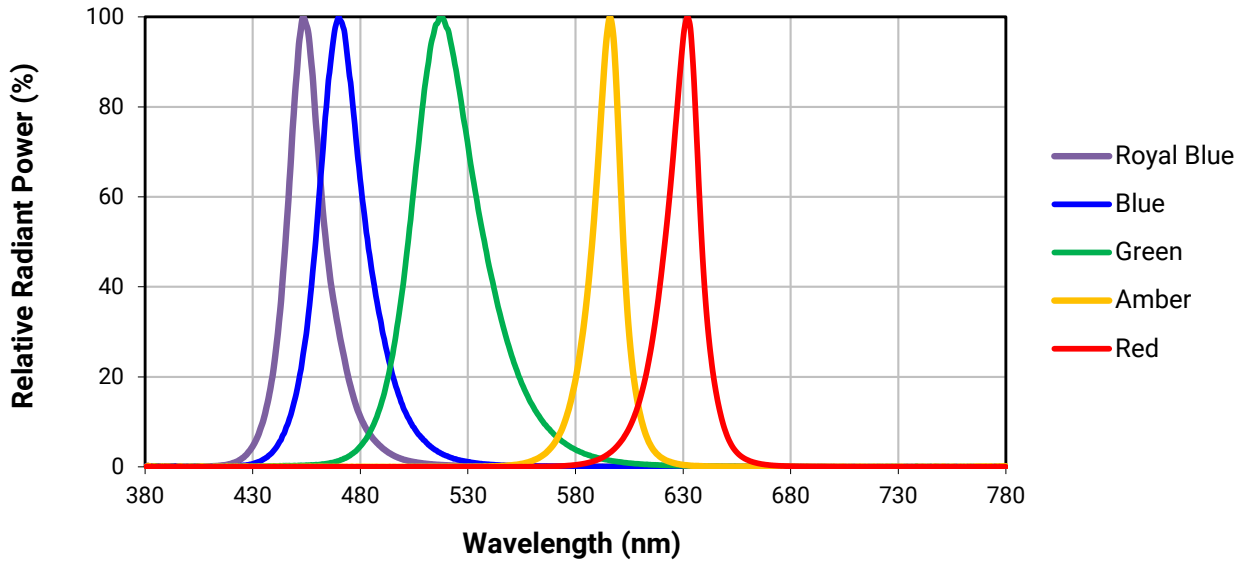

RELATIVE LUMINOUS FLUX VS. JUNCTION TEMPERATURE - WHITE (PARALLEL: $I_F = 150$ mA, SERIES: $I_F = 50$ mA)

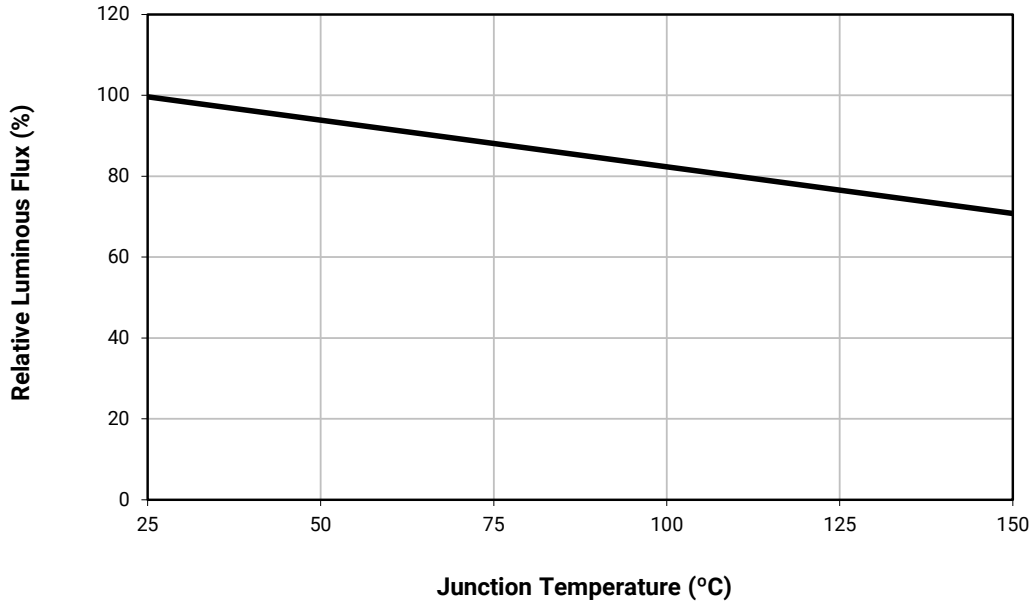

RELATIVE LUMINOUS FLUX VS. JUNCTION TEMPERATURE - PARALLEL: BLUE, GREEN, AMBER, RED ($I_F = 150$ mA), SERIES: BLUE, GREEN ($I_F = 50$ mA), AMBER, RED ($I_F = 37.5$ mA)

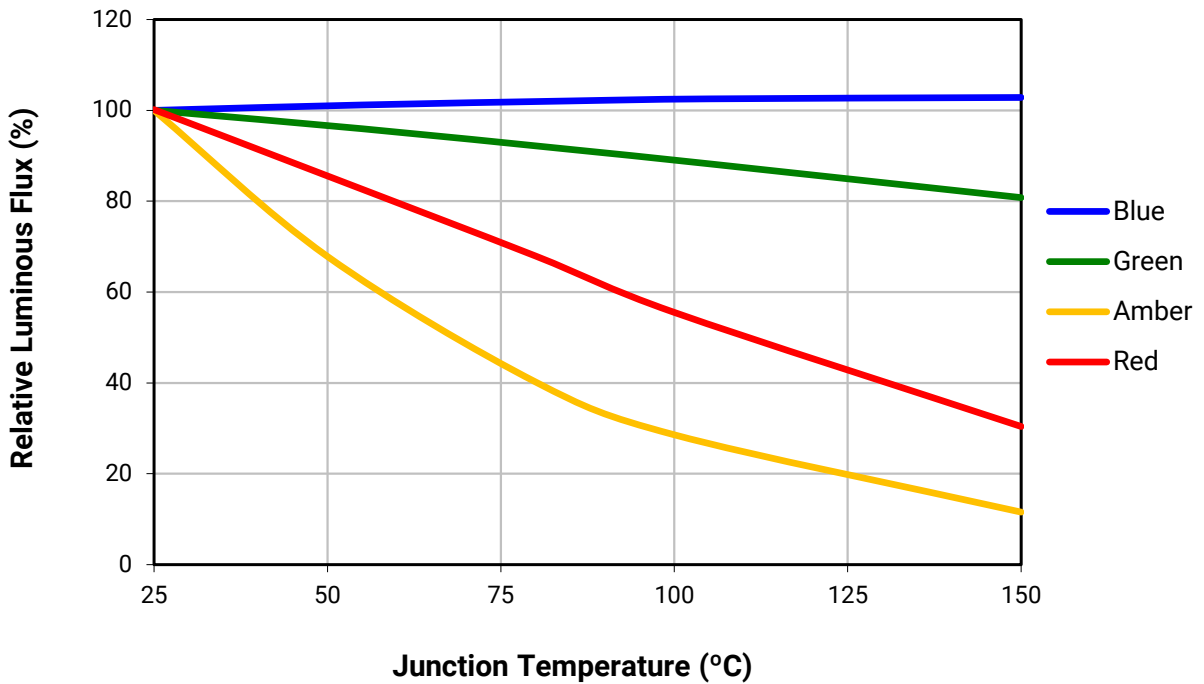

RELATIVE RADIANT FLUX VS. JUNCTION TEMPERATURE - PARALLEL ROYAL BLUE ($I_f = 150 \text{ mA}$)

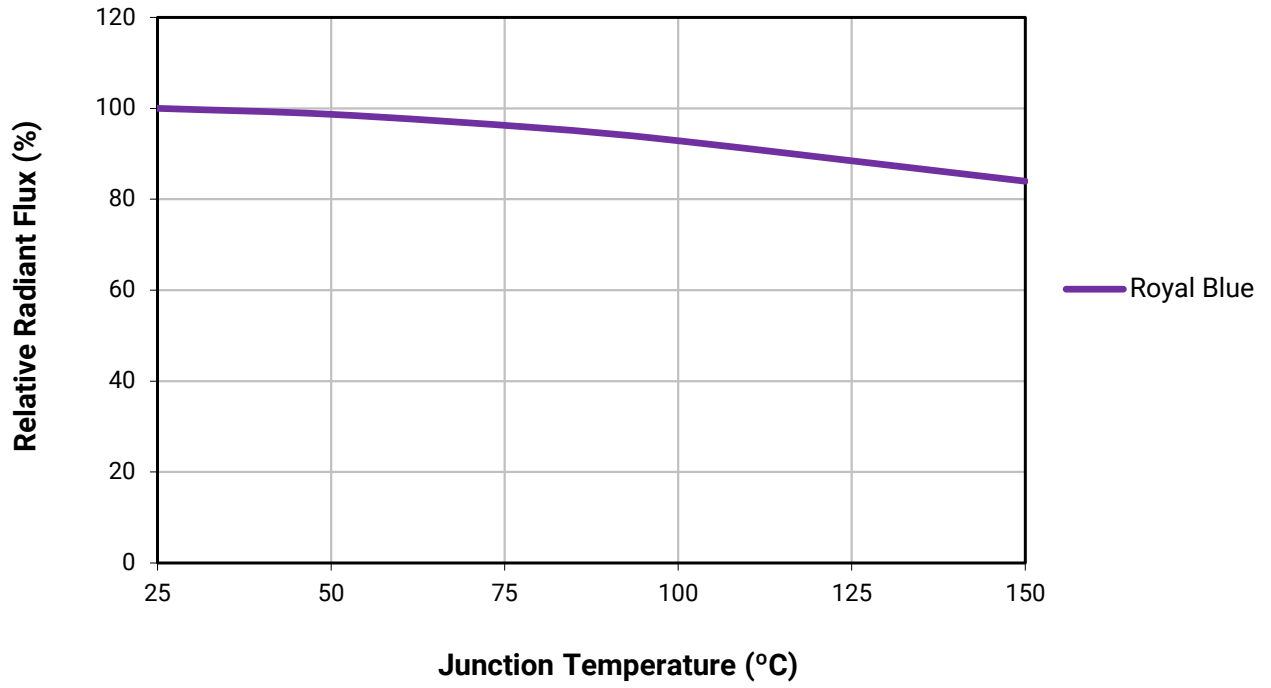

ELECTRICAL CHARACTERISTICS - PARALLEL WHITE ($T_j = 25\text{ }^\circ\text{C}$)

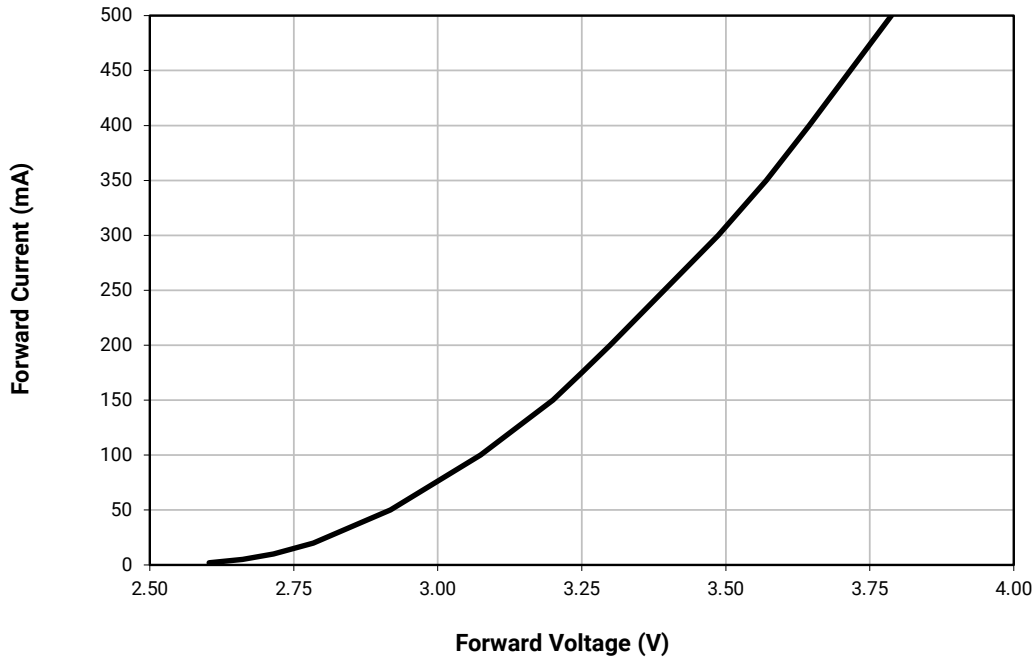

ELECTRICAL CHARACTERISTICS - SERIES WHITE ($T_j = 25\text{ }^\circ\text{C}$)

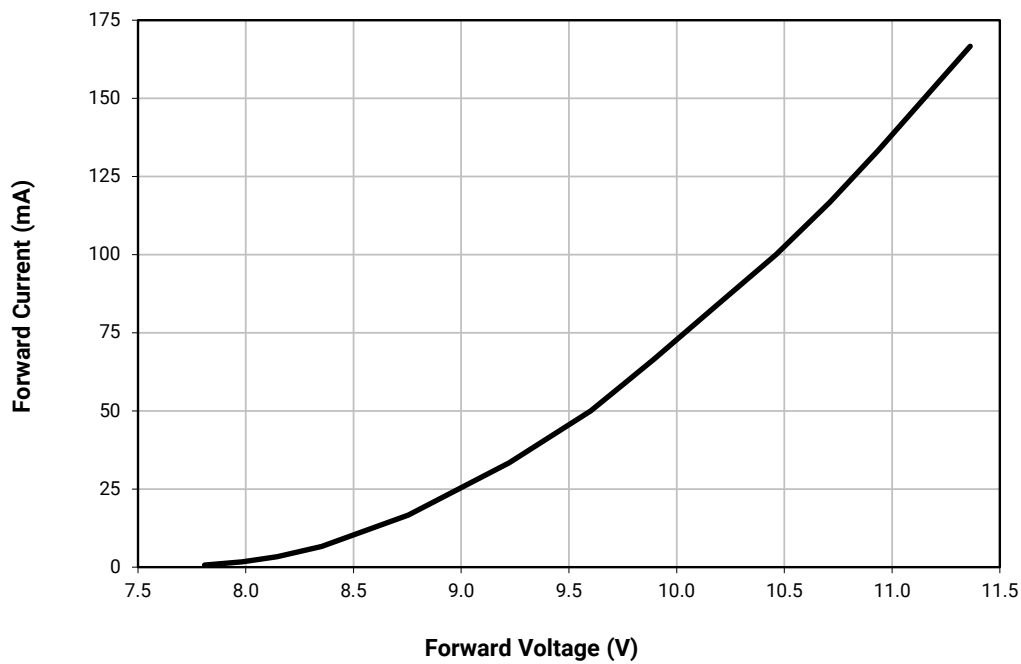

ELECTRICAL CHARACTERISTICS - PARALLEL COLOR ($T_j = 25\text{ }^\circ\text{C}$)

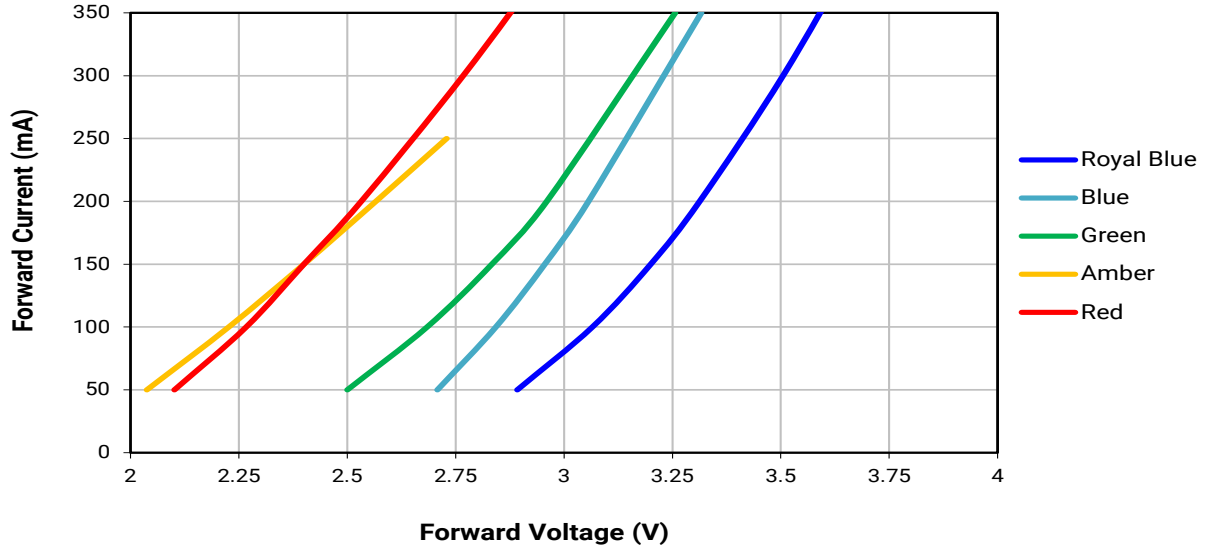

ELECTRICAL CHARACTERISTICS - SERIES COLOR ($T_j = 25\text{ }^\circ\text{C}$)

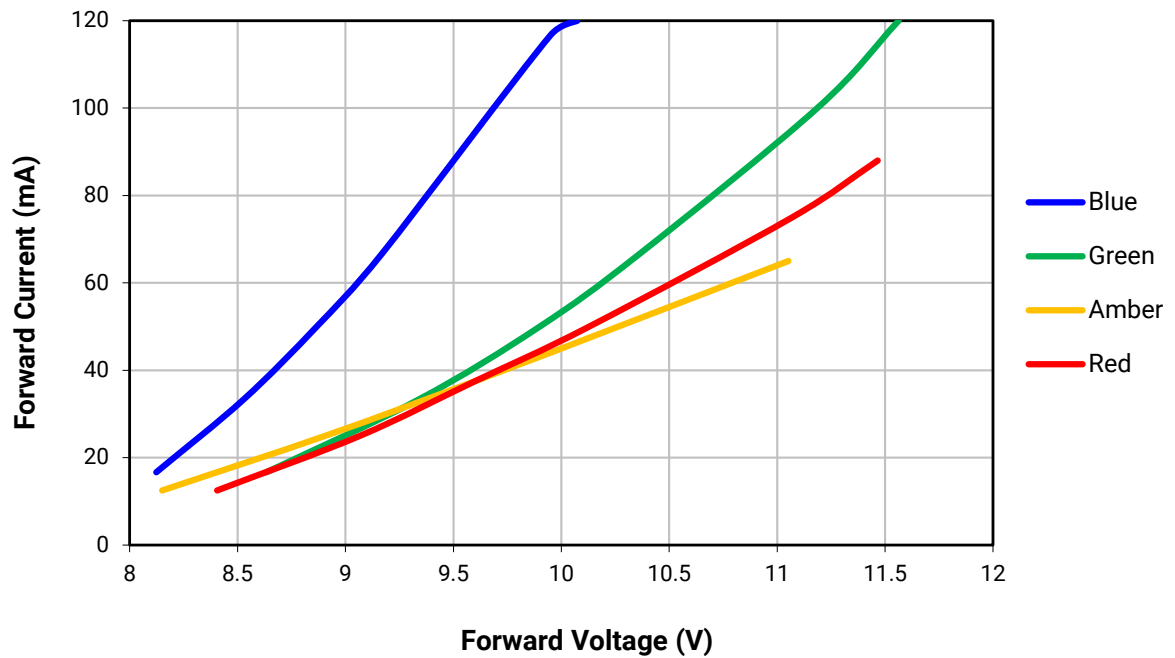

RELATIVE LUMINOUS FLUX VS. CURRENT - PARALLEL WHITE ($T_j = 25\text{ }^\circ\text{C}$)

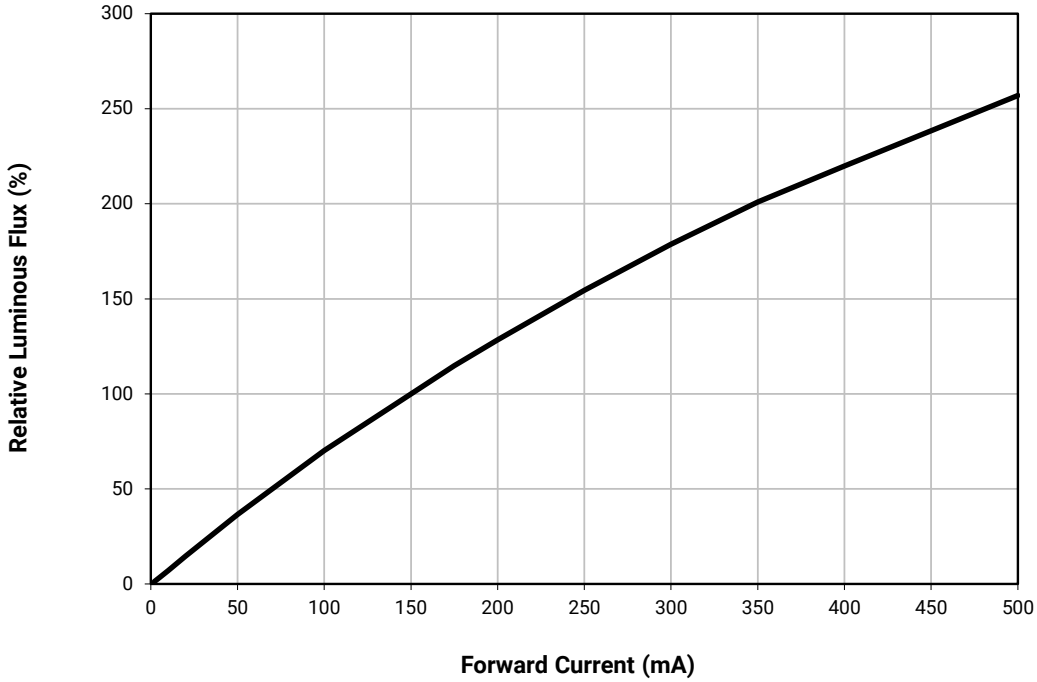

RELATIVE LUMINOUS FLUX VS. CURRENT - SERIES WHITE ($T_j = 25\text{ }^\circ\text{C}$)

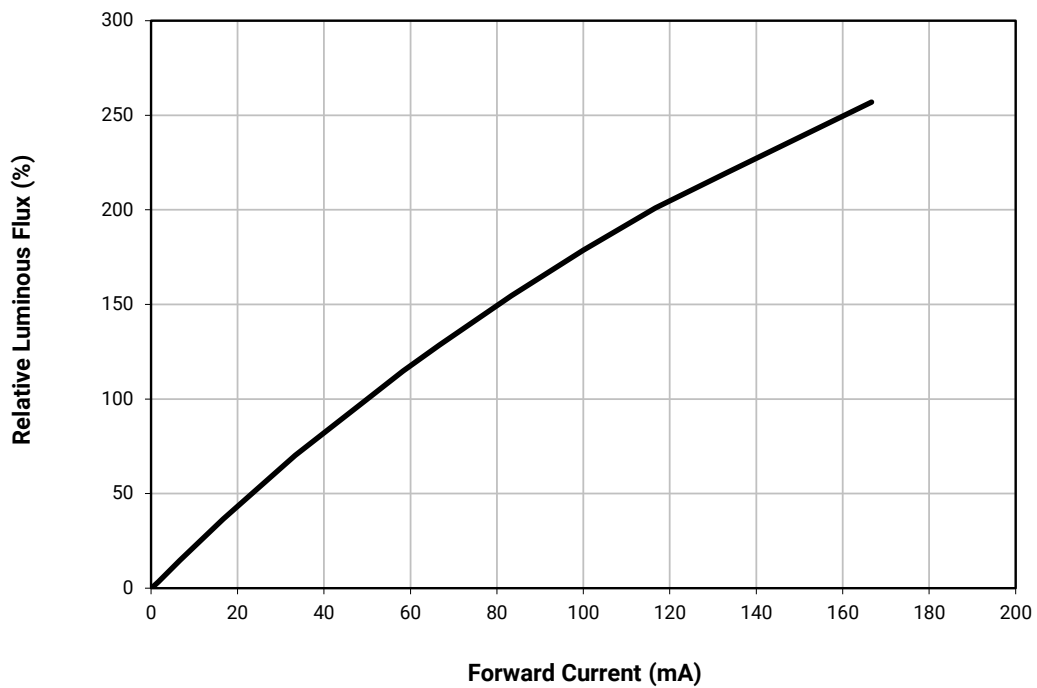

RELATIVE LUMINOUS FLUX VS. CURRENT - PARALLEL BLUE, GREEN, AMBER, RED ($T_j = 25\text{ }^\circ\text{C}$)

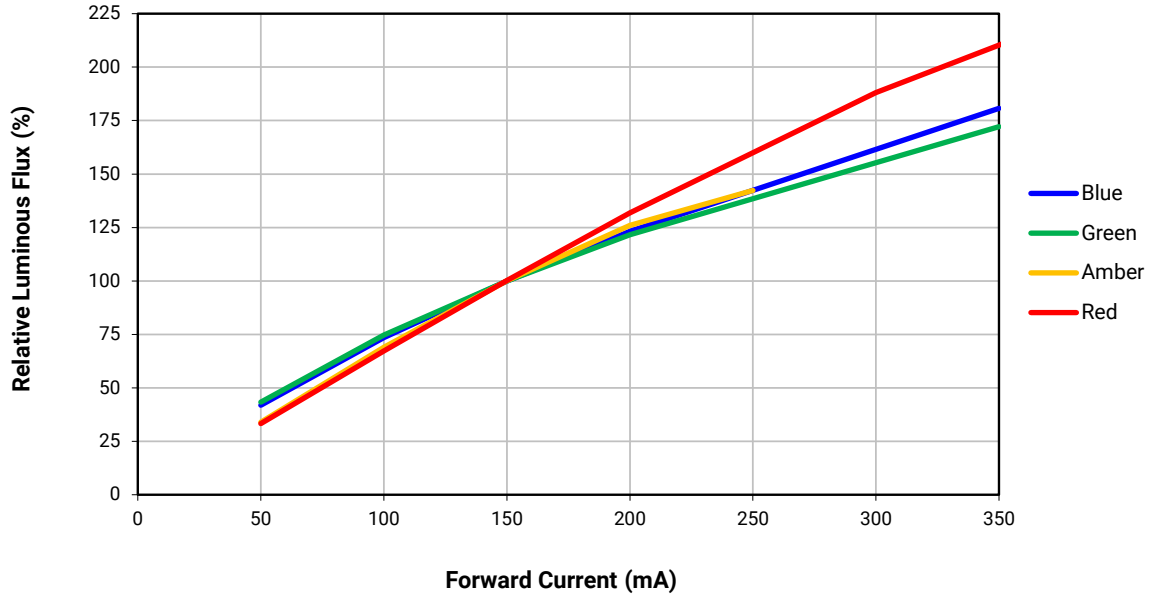

RELATIVE LUMINOUS FLUX VS. CURRENT - SERIES BLUE, GREEN, AMBER, RED ($T_j = 25\text{ }^\circ\text{C}$)

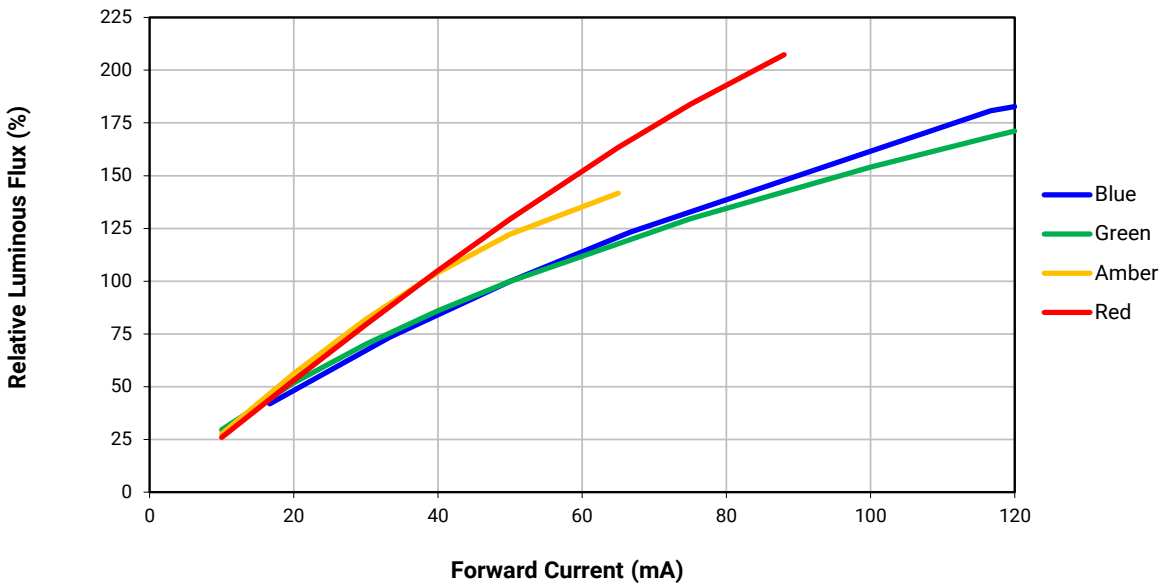

RELATIVE RADIANT FLUX VS. CURRENT - PARALLEL ROYAL BLUE ($T_j = 25\text{ }^\circ\text{C}$)

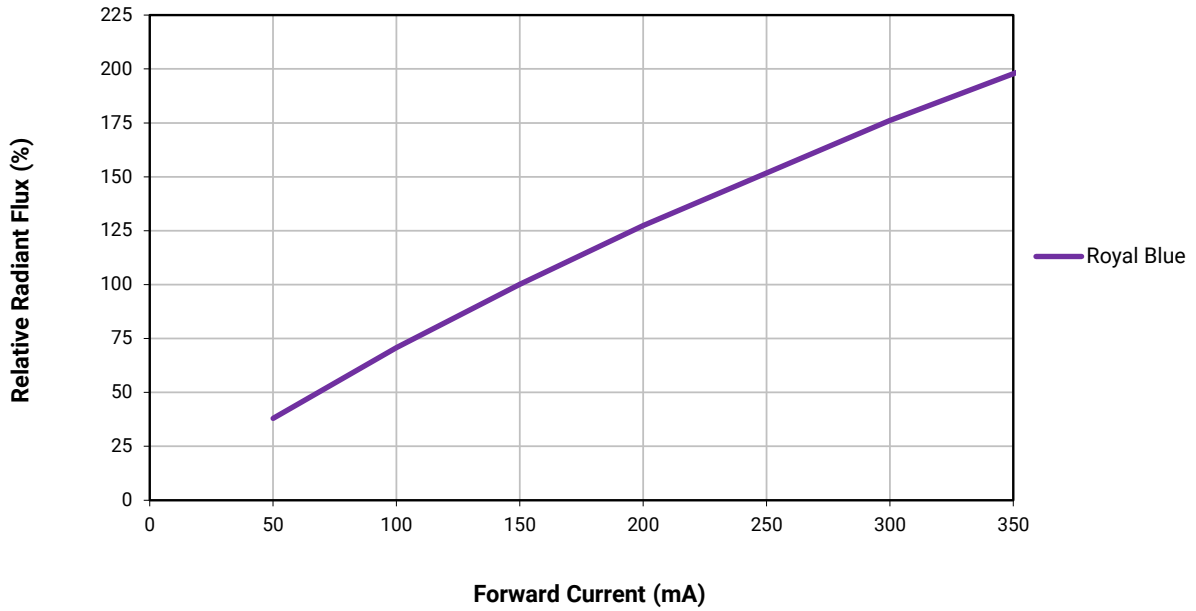

TYPICAL SPATIAL DISTRIBUTION - WHITE

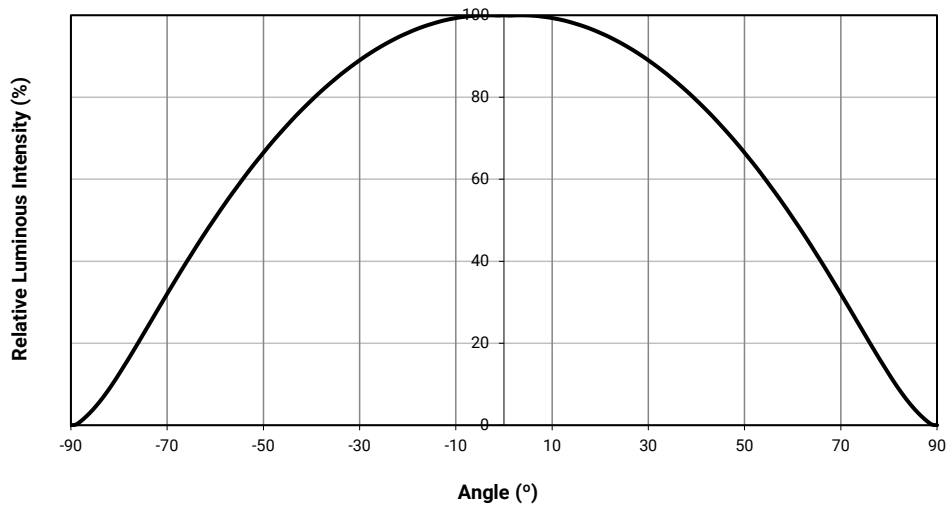

TYPICAL SPATIAL DISTRIBUTION - ROYAL BLUE, BLUE, GREEN

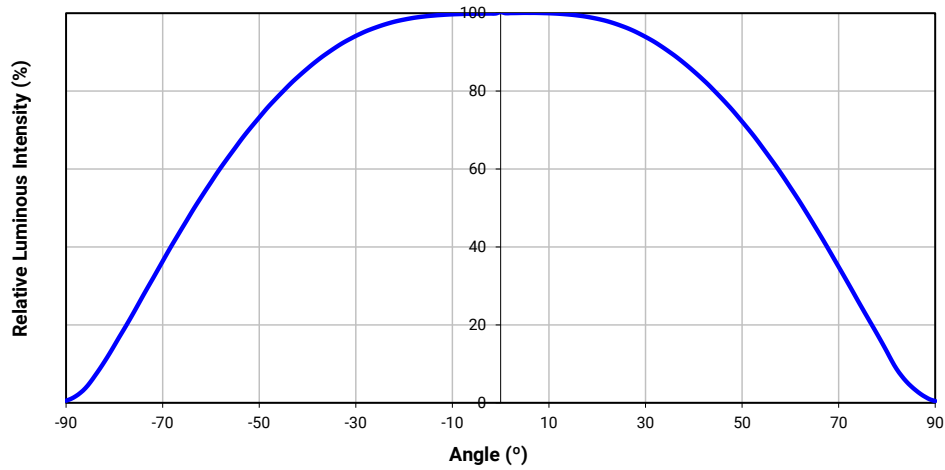

TYPICAL SPATIAL DISTRIBUTION - AMBER, RED

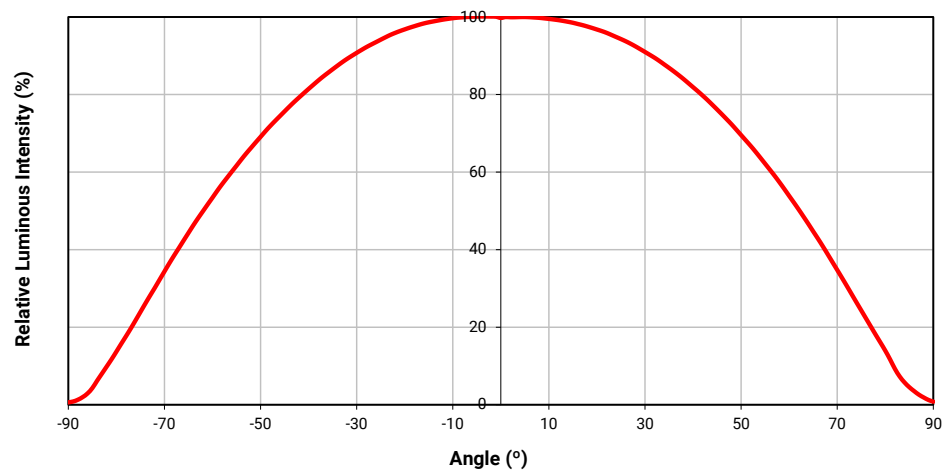

THERMAL DESIGN - PARALLEL WHITE

The maximum forward current is determined by the thermal resistance between the LED junction and ambient. It is crucial for the end product to be designed in a manner that minimizes the thermal resistance from the solder point to ambient in order to optimize lamp life and optical characteristics.

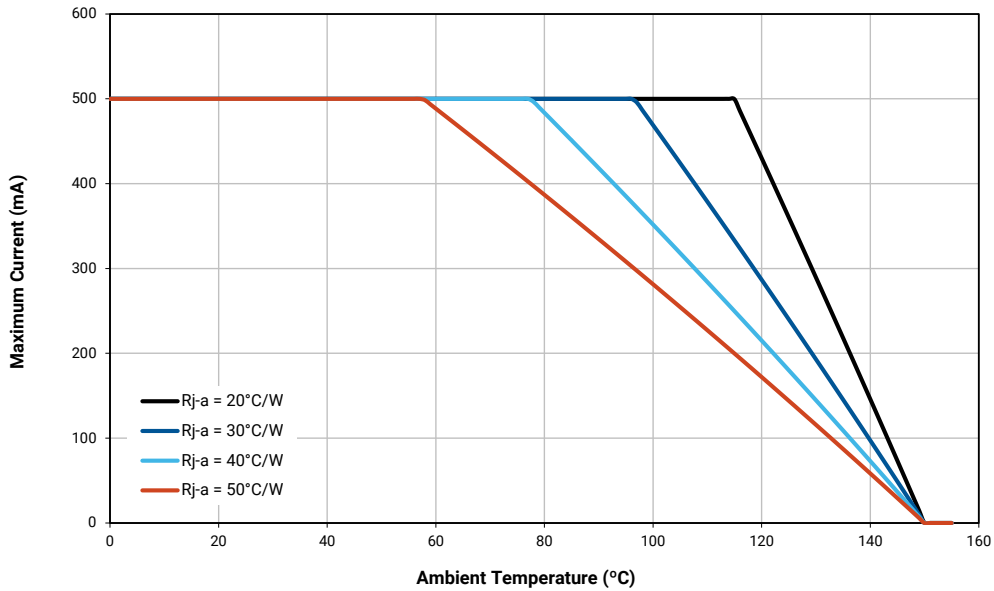

THERMAL DESIGN - SERIES WHITE

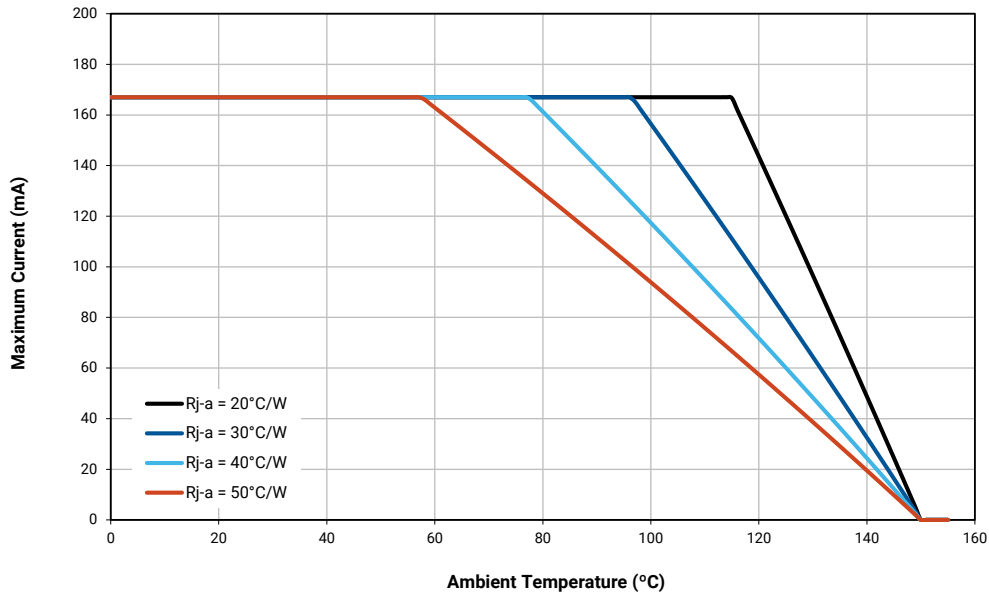

THERMAL DESIGN - PARALLEL ROYAL BLUE

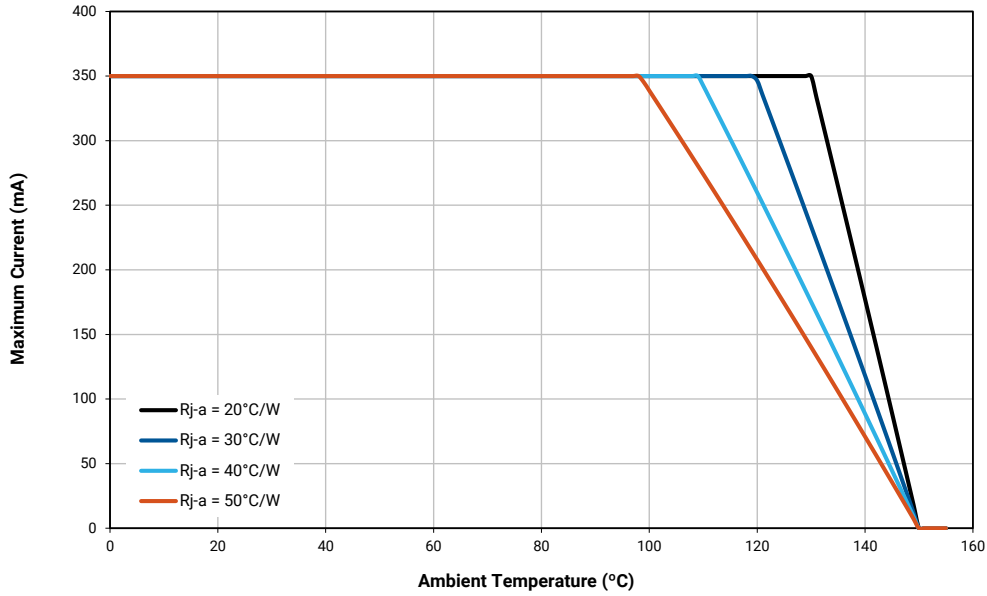

THERMAL DESIGN - PARALLEL BLUE

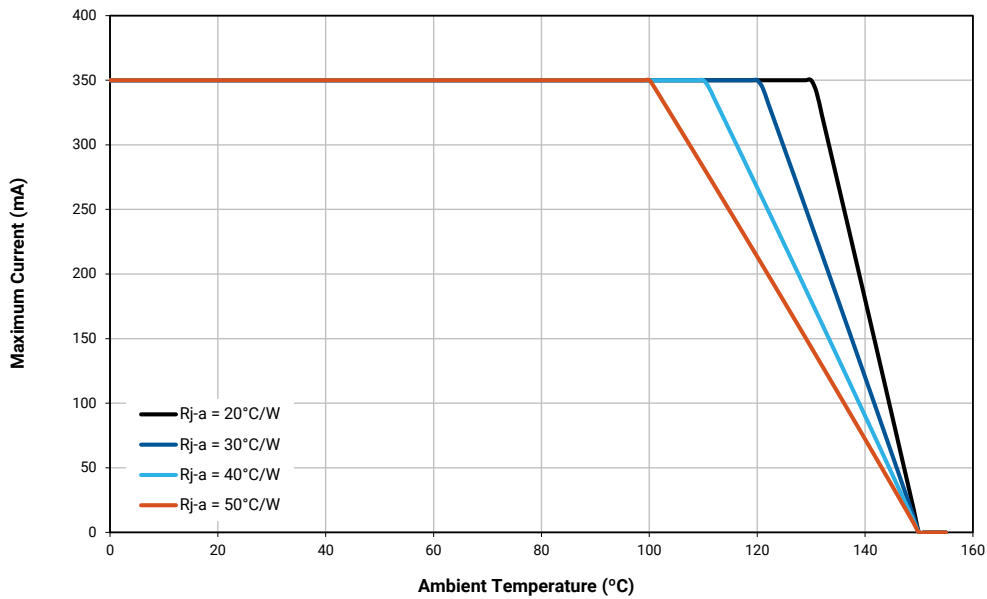

THERMAL DESIGN - SERIES BLUE

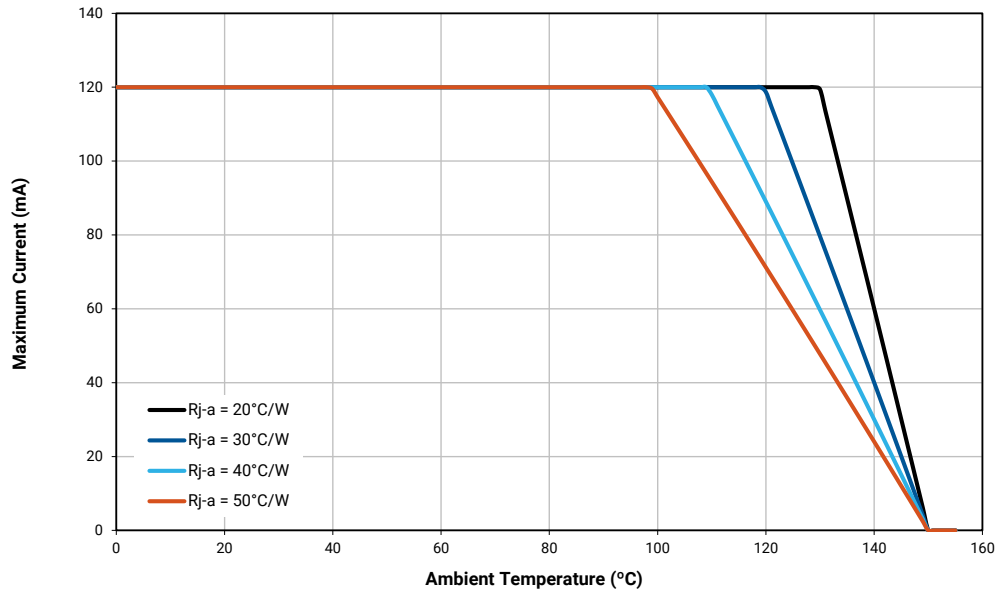

THERMAL DESIGN - PARALLEL GREEN

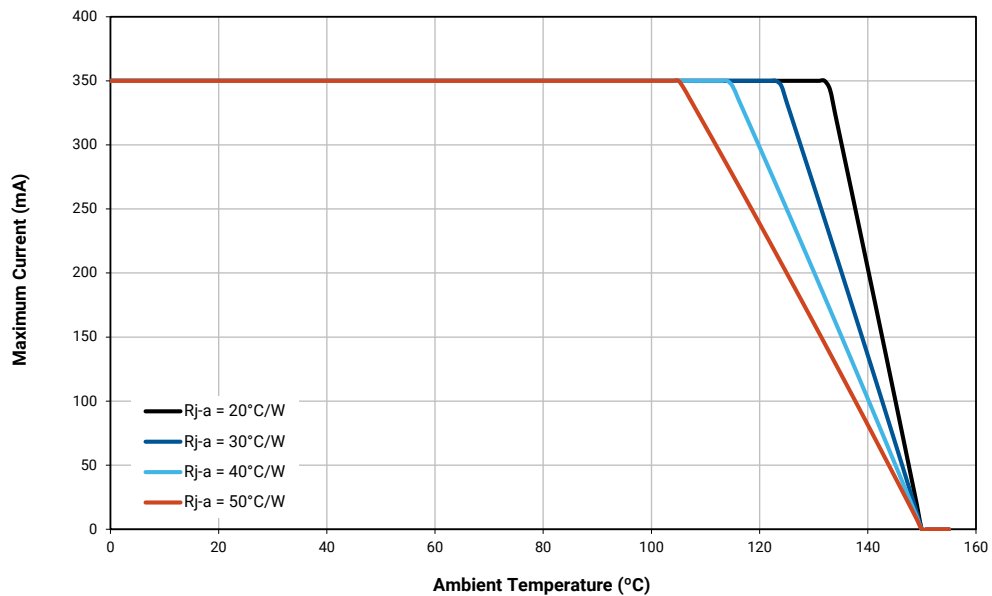

THERMAL DESIGN - SERIES GREEN

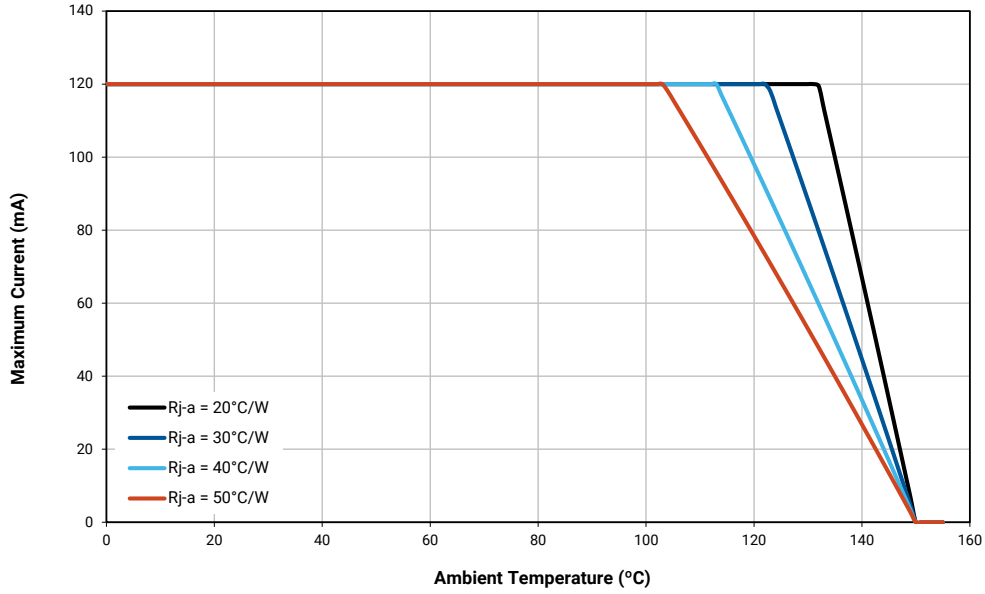

THERMAL DESIGN - PARALLEL AMBER

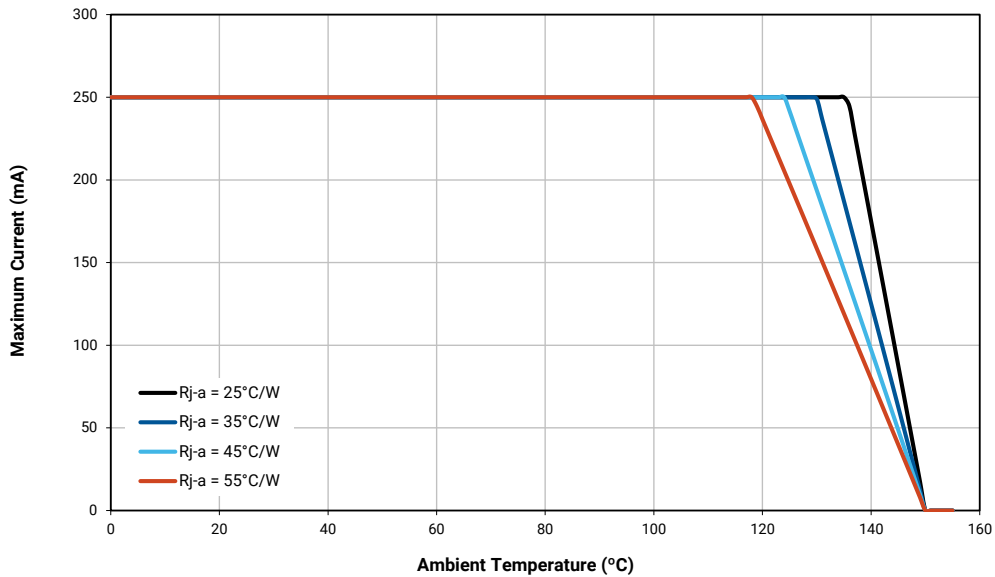

THERMAL DESIGN - SERIES AMBER

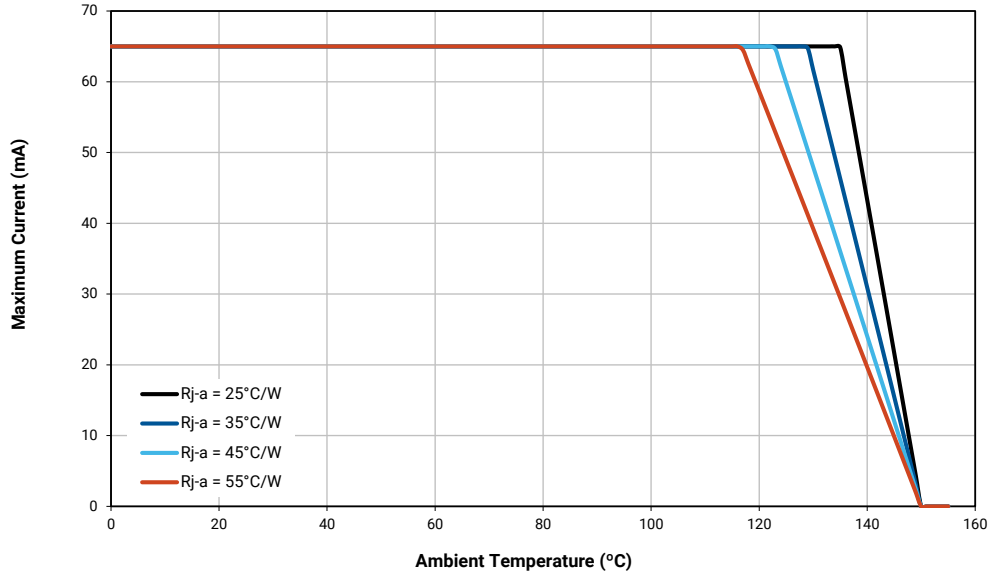

THERMAL DESIGN - PARALLEL RED

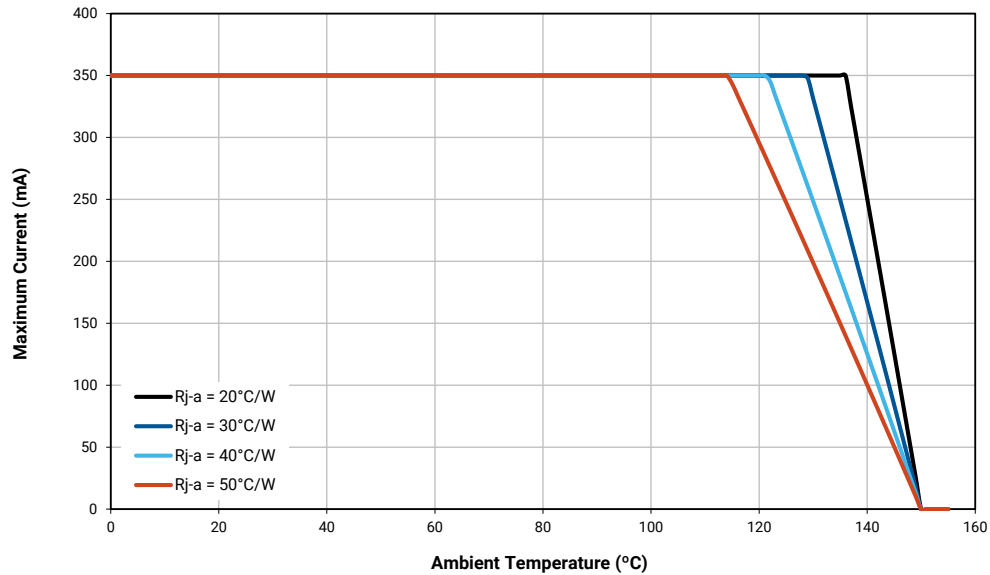

THERMAL DESIGN - SERIES RED

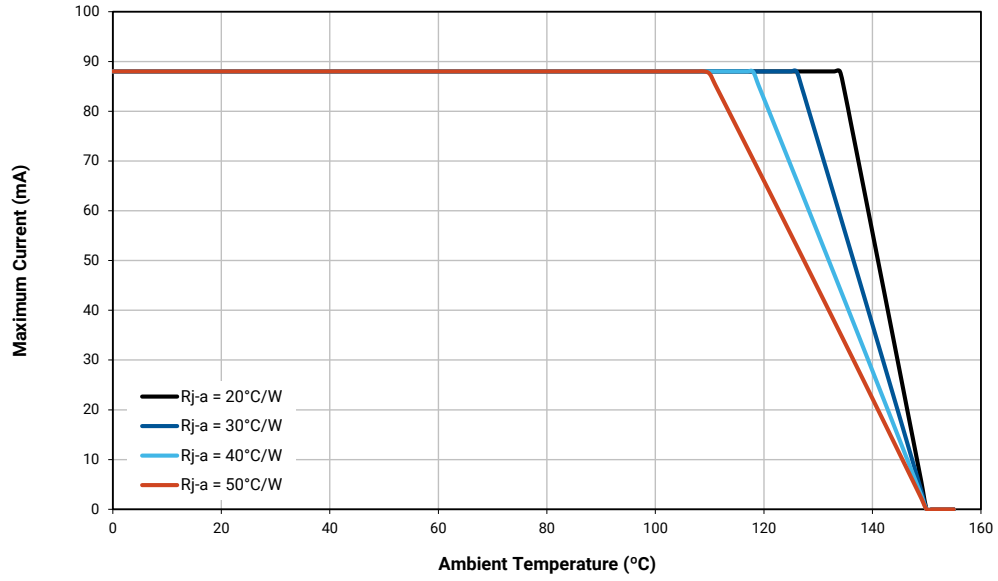

PERFORMANCE GROUPS – LUMINOUS OR RADIANT FLUX

White and color ML-E LEDs (except for royal-blue) are tested for luminous flux and placed into one of the following luminous-flux groups:

Group Code	Minimum Luminous Flux (lm)	Maximum Luminous Flux (lm)
F2	10.7	12.3
F3	12.3	13.9
G2	13.9	15.8
G3	15.8	18.1
H2	18.1	20.6
H3	20.6	23.5
J2	23.5	26.8
J3	26.8	30.6
K2	30.6	35.2
K3	35.2	39.8
M2	39.8	45.7
M3	45.7	51.7
N2	51.7	56.8
N3	56.8	62
N4	62	67.2
P2	67.2	73.9
P3	73.9	80.6

Royal-blue ML-E LEDs are tested for radiant flux and sorted into one of the following radiant-flux bins.

Group	Minimum Radiant Flux (mW)	Maximum Radiant Flux (mW)
09	147	175
10	175	210
11	210	250

PERFORMANCE GROUPS – DOMINANT WAVELENGTH

ML-E color LEDs are tested individually for dominant wavelength (DWL) and sorted into one of the DWL bins defined below.

Color	DWL Group	Minimum DWL (nm)	Maximum DWL (nm)
Royal Blue	D36	450	452.5
	D37	452.5	455
	D46	455	457.5
	D47	457.5	460
	D56	460	462.5
	D57	462.5	465
Blue	B3	465	470
	B4	470	475
	B5	475	480
	B6	480	485
Green	G2	520	525
	G3	525	530
	G4	530	535
Amber	A2	585	590
	A3	590	595
Red	R2	620	625
	R3	625	630

PERFORMANCE GROUPS – CHROMATICITY

Region	x	y	Region	x	y	Region	x	y	Region	x	y
0A	0.2950	0.2970	0B	0.2920	0.3060	0C	0.2984	0.3133	0D	0.2984	0.3133
	0.2920	0.3060		0.2895	0.3135		0.2962	0.3220		0.3048	0.3207
	0.2984	0.3133		0.2962	0.3220		0.3028	0.3304		0.3068	0.3113
	0.3009	0.3042		0.2984	0.3133		0.3048	0.3207		0.3009	0.3042
0R	0.2980	0.2880	0S	0.2895	0.3135	0T	0.2962	0.3220	0U	0.3037	0.2937
	0.2950	0.2970		0.2870	0.3210		0.2937	0.3312		0.3009	0.3042
	0.3009	0.3042		0.2937	0.3312		0.3005	0.3415		0.3068	0.3113
	0.3037	0.2937		0.2962	0.3220		0.3028	0.3304		0.3093	0.2993
1A	0.3048	0.3207	1B	0.3028	0.3304	1C	0.3115	0.3391	1D	0.3130	0.3290
	0.3130	0.3290		0.3115	0.3391		0.3205	0.3481		0.3213	0.3373
	0.3144	0.3186		0.3130	0.3290		0.3213	0.3373		0.3221	0.3261
	0.3068	0.3113		0.3048	0.3207		0.3130	0.3290		0.3144	0.3186
1R	0.3068	0.3113	1S	0.3005	0.3415	1T	0.3099	0.3509	1U	0.3144	0.3186
	0.3144	0.3186		0.3099	0.3509		0.3196	0.3602		0.3221	0.3261
	0.3161	0.3059		0.3115	0.3391		0.3205	0.3481		0.3231	0.3120
	0.3093	0.2993		0.3028	0.3304		0.3115	0.3391		0.3161	0.3059
2A	0.3215	0.3350	2B	0.3207	0.3462	2C	0.3290	0.3538	2D	0.3290	0.3417
	0.3290	0.3417		0.3290	0.3538		0.3376	0.3616		0.3371	0.3490
	0.3290	0.3300		0.3290	0.3417		0.3371	0.3490		0.3366	0.3369
	0.3222	0.3243		0.3215	0.3350		0.3290	0.3417		0.3290	0.3300
2R	0.3222	0.3243	2S	0.3196	0.3602	2T	0.3290	0.3690	2U	0.3290	0.3300
	0.3290	0.3300		0.3290	0.3690		0.3381	0.3762		0.3366	0.3369
	0.3290	0.3180		0.3290	0.3538		0.3376	0.3616		0.3361	0.3245
	0.3231	0.3120		0.3207	0.3462		0.3290	0.3538		0.3290	0.3180
3A	0.3371	0.3490	3B	0.3376	0.3616	3C	0.3463	0.3687	3D	0.3451	0.3554
	0.3451	0.3554		0.3463	0.3687		0.3551	0.3760		0.3533	0.3620
	0.3440	0.3427		0.3451	0.3554		0.3533	0.3620		0.3515	0.3487
	0.3366	0.3369		0.3371	0.3490		0.3451	0.3554		0.3440	0.3427
3R	0.3366	0.3369	3S	0.3381	0.3762	3T	0.3480	0.3840	3U	0.3440	0.3428
	0.3440	0.3428		0.3480	0.3840		0.3571	0.3907		0.3515	0.3487
	0.3429	0.3307		0.3463	0.3687		0.3551	0.3760		0.3495	0.3339
	0.3361	0.3245		0.3376	0.3616		0.3463	0.3687		0.3429	0.3307
4A	0.3530	0.3597	4B	0.3548	0.3736	4C	0.3641	0.3804	4D	0.3615	0.3659
	0.3615	0.3659		0.3641	0.3804		0.3736	0.3874		0.3702	0.3722
	0.3590	0.3521		0.3615	0.3659		0.3702	0.3722		0.3670	0.3578
	0.3512	0.3465		0.3530	0.3597		0.3615	0.3659		0.3590	0.3521

PERFORMANCE GROUPS – CHROMATICITY (CONTINUED)

Region	x	y	Region	x	y	Region	x	y	Region	x	y
4R	0.3512	0.3465	4S	0.3571	0.3907						
	0.3590	0.3521		0.3668	0.3957						
	0.3567	0.3389		0.3641	0.3804						
	0.3495	0.3339		0.3548	0.3736						
5A1	0.3670	0.3578	5A2	0.3686	0.3649	5A3	0.3744	0.3685	5A4	0.3726	0.3612
	0.3686	0.3649		0.3702	0.3722		0.3763	0.3760		0.3744	0.3685
	0.3744	0.3685		0.3763	0.3760		0.3825	0.3798		0.3804	0.3721
	0.3726	0.3612		0.3744	0.3685		0.3804	0.3721		0.3783	0.3646
5B1	0.3702	0.3722	5B2	0.3719	0.3797	5B3	0.3782	0.3837	5B4	0.3763	0.3760
	0.3719	0.3797		0.3736	0.3874		0.3802	0.3916		0.3782	0.3837
	0.3782	0.3837		0.3802	0.3916		0.3869	0.3958		0.3847	0.3877
	0.3763	0.3760		0.3782	0.3837		0.3847	0.3877		0.3825	0.3798
5C1	0.3825	0.3798	5C2	0.3847	0.3877	5C3	0.3912	0.3917	5C4	0.3887	0.3836
	0.3847	0.3877		0.3869	0.3958		0.3937	0.4001		0.3912	0.3917
	0.3912	0.3917		0.3937	0.4001		0.4006	0.4044		0.3978	0.3958
	0.3887	0.3836		0.3912	0.3917		0.3978	0.3958		0.3950	0.3875
5D1	0.3783	0.3646	5D2	0.3804	0.3721	5D3	0.3863	0.3758	5D4	0.3840	0.3681
	0.3804	0.3721		0.3825	0.3798		0.3887	0.3836		0.3863	0.3758
	0.3863	0.3758		0.3887	0.3836		0.3950	0.3875		0.3924	0.3794
	0.3840	0.3681		0.3863	0.3758		0.3924	0.3794		0.3898	0.3716
6A1	0.3889	0.3690	6A2	0.3915	0.3768	6A3	0.3981	0.3800	6A4	0.3953	0.3720
	0.3915	0.3768		0.3941	0.3848		0.4010	0.3882		0.3981	0.3800
	0.3981	0.3800		0.4010	0.3882		0.4080	0.3916		0.4048	0.3832
	0.3953	0.3720		0.3981	0.3800		0.4048	0.3832		0.4017	0.3751
6B1	0.3941	0.3848	6B2	0.3968	0.3930	6B3	0.4040	0.3966	6B4	0.4010	0.3882
	0.3968	0.3930		0.3996	0.4015		0.4071	0.4052		0.4040	0.3966
	0.4040	0.3966		0.4071	0.4052		0.4146	0.4089		0.4113	0.4001
	0.4010	0.3882		0.4040	0.3966		0.4113	0.4001		0.4080	0.3916
6C1	0.4080	0.3916	6C2	0.4113	0.4001	6C3	0.4186	0.4037	6C4	0.4150	0.3950
	0.4113	0.4001		0.4146	0.4089		0.4222	0.4127		0.4186	0.4037
	0.4186	0.4037		0.4222	0.4127		0.4299	0.4165		0.4259	0.4073
	0.4150	0.3950		0.4186	0.4037		0.4259	0.4073		0.4221	0.3984
6D1	0.4017	0.3751	6D2	0.4048	0.3832	6D3	0.4116	0.3865	6D4	0.4082	0.3782
	0.4048	0.3832		0.4080	0.3916		0.4150	0.3950		0.4116	0.3865
	0.4116	0.3865		0.4150	0.3950		0.4221	0.3984		0.4183	0.3898
	0.4082	0.3782		0.4116	0.3865		0.4183	0.3898		0.4147	0.3814
7A1	0.4147	0.3814	7A2	0.4183	0.3898	7A3	0.4242	0.3919	7A4	0.4203	0.3833
	0.4183	0.3898		0.4221	0.3984		0.4281	0.4006		0.4242	0.3919
	0.4242	0.3919		0.4281	0.4006		0.4342	0.4028		0.4300	0.3939
	0.4203	0.3833		0.4242	0.3919		0.4300	0.3939		0.4259	0.3853

PERFORMANCE GROUPS – CHROMATICITY (CONTINUED)

Region	x	y	Region	x	y	Region	x	y	Region	x	y
7B1	0.4221	0.3984	7B2	0.4259	0.4073	7B3	0.4322	0.4096	7B4	0.4281	0.4006
	0.4259	0.4073		0.4299	0.4165		0.4364	0.4188		0.4322	0.4096
	0.4322	0.4096		0.4364	0.4188		0.4430	0.4212		0.4385	0.4119
	0.4281	0.4006		0.4322	0.4096		0.4385	0.4119		0.4342	0.4028
7C1	0.4342	0.4028	7C2	0.4385	0.4119	7C3	0.4449	0.4141	7C4	0.4403	0.4049
	0.4385	0.4119		0.4430	0.4212		0.4496	0.4236		0.4449	0.4141
	0.4449	0.4141		0.4496	0.4236		0.4562	0.4260		0.4513	0.4164
	0.4403	0.4049		0.4449	0.4141		0.4513	0.4164		0.4465	0.4071
7D1	0.4259	0.3853	7D2	0.4300	0.3939	7D3	0.4359	0.3960	7D4	0.4316	0.3873
	0.4300	0.3939		0.4342	0.4028		0.4403	0.4049		0.4359	0.3960
	0.4359	0.3960		0.4403	0.4049		0.4465	0.4071		0.4418	0.3981
	0.4316	0.3873		0.4359	0.3960		0.4418	0.3981		0.4373	0.3893
8A1	0.4373	0.3893	8A2	0.4418	0.3981	8A3	0.4475	0.3994	8A4	0.4428	0.3906
	0.4418	0.3981		0.4465	0.4071		0.4523	0.4085		0.4475	0.3994
	0.4475	0.3994		0.4523	0.4085		0.4582	0.4099		0.4532	0.4008
	0.4428	0.3906		0.4475	0.3994		0.4532	0.4008		0.4483	0.3919
8B1	0.4465	0.4071	8B2	0.4513	0.4164	8B3	0.4573	0.4178	8B4	0.4523	0.4085
	0.4513	0.4164		0.4562	0.4260		0.4624	0.4274		0.4573	0.4178
	0.4573	0.4178		0.4624	0.4274		0.4687	0.4289		0.4634	0.4193
	0.4523	0.4085		0.4573	0.4178		0.4634	0.4193		0.4582	0.4099
8C1	0.4582	0.4099	8C2	0.4634	0.4193	8C3	0.4695	0.4207	8C4	0.4641	0.4112
	0.4634	0.4193		0.4687	0.4289		0.4750	0.4304		0.4695	0.4207
	0.4695	0.4207		0.4750	0.4304		0.4813	0.4319		0.4756	0.4221
	0.4641	0.4112		0.4695	0.4207		0.4756	0.4221		0.4700	0.4126
8D1	0.4483	0.3919	8D2	0.4532	0.4008	8D3	0.4589	0.4021	8D4	0.4538	0.3931
	0.4532	0.4008		0.4582	0.4099		0.4641	0.4112		0.4589	0.4021
	0.4589	0.4021		0.4641	0.4112		0.4700	0.4126		0.4646	0.4034
	0.4538	0.3931		0.4589	0.4021		0.4646	0.4034		0.4593	0.3944

STANDARD COOL WHITE KITS PLOTTED ON ANSI STANDARD CHROMATICITY REGIONS

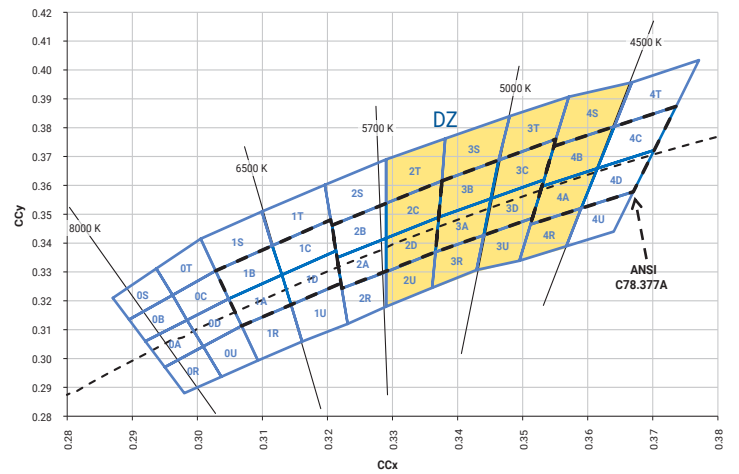
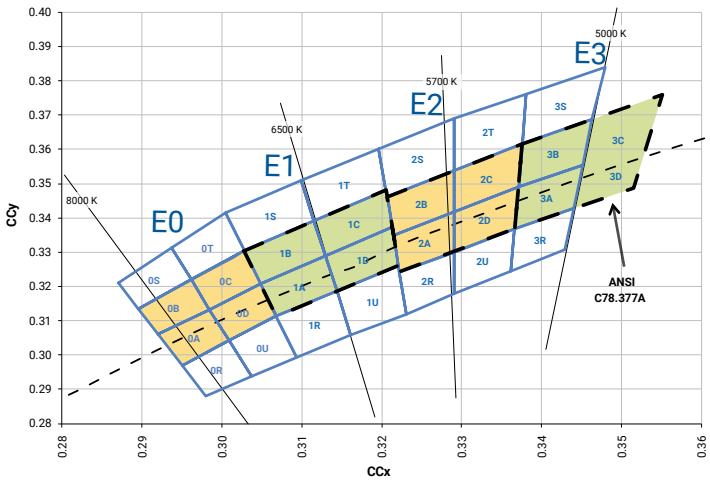
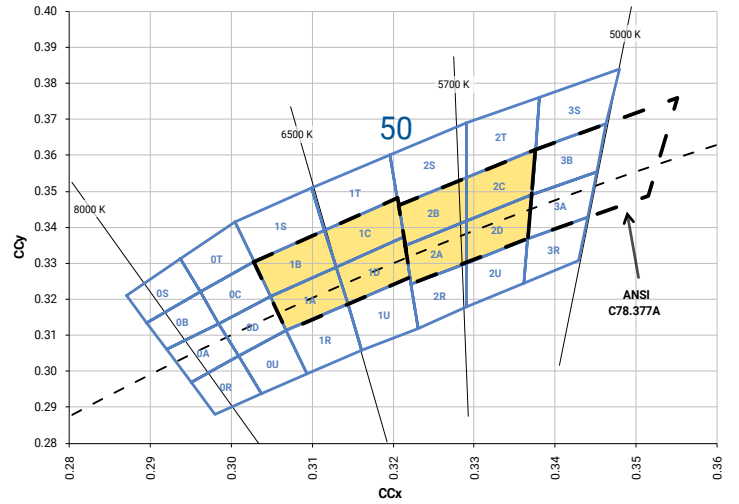
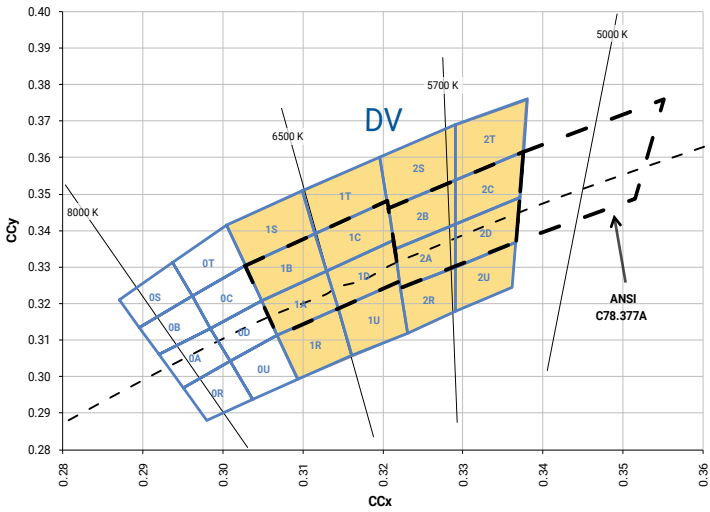
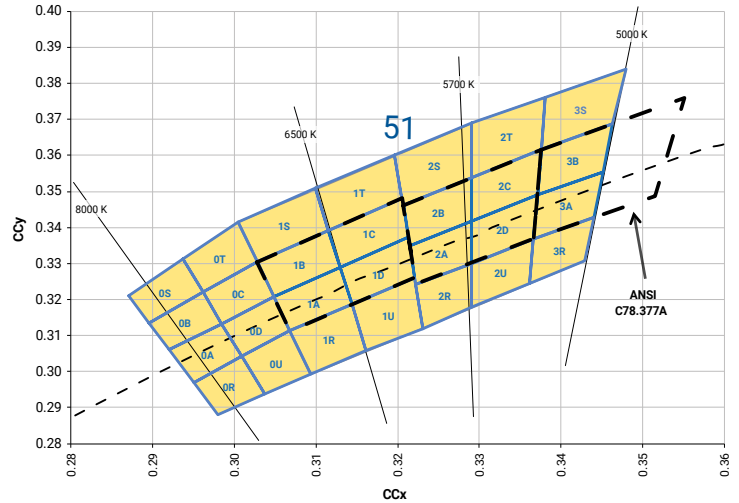
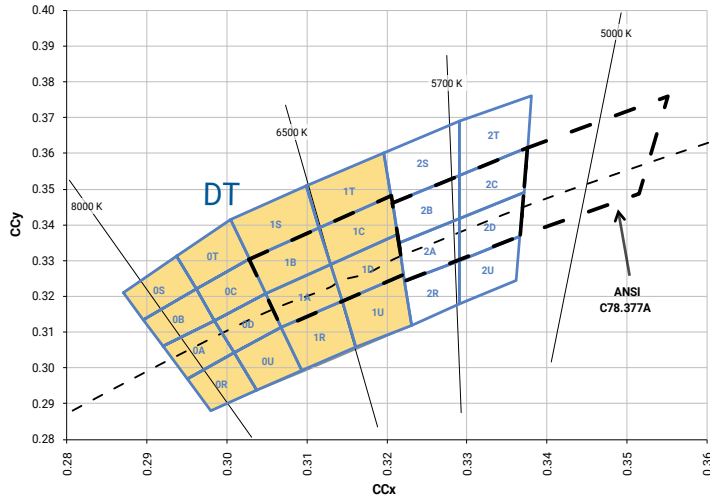

STANDARD COOL WHITE KITS PLOTTED ON ANSI STANDARD CHROMATICITY REGIONS - CONTINUED

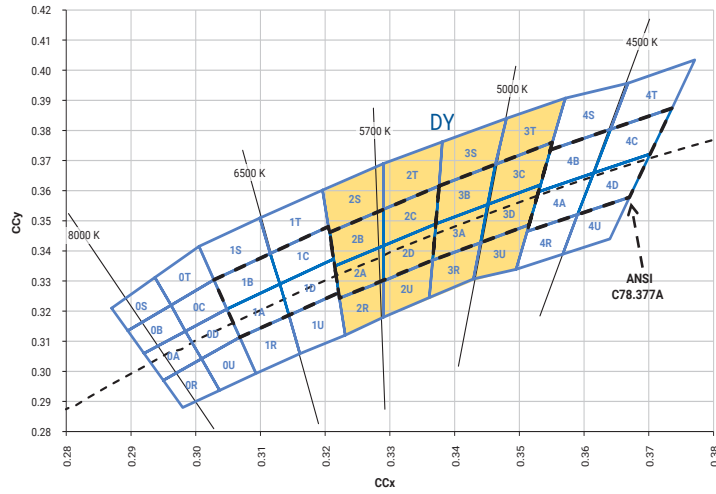

STANDARD WARM AND NEUTRAL WHITE KITS PLOTTED ON ANSI STANDARD CHROMATICITY REGIONS

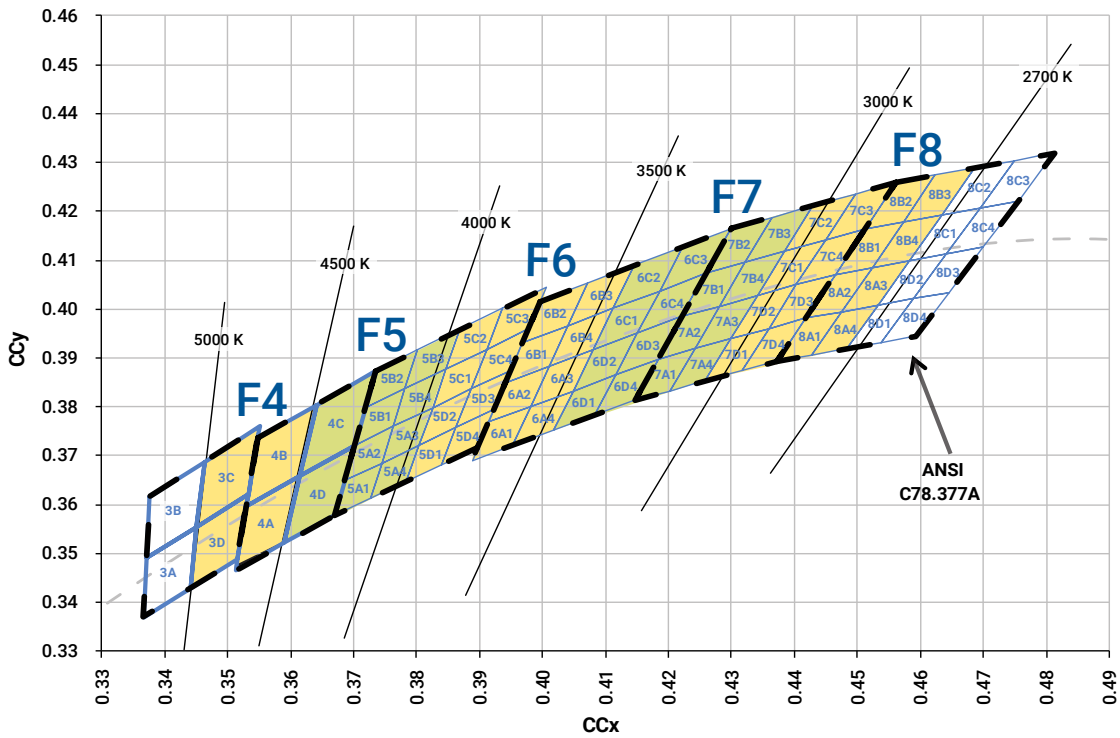
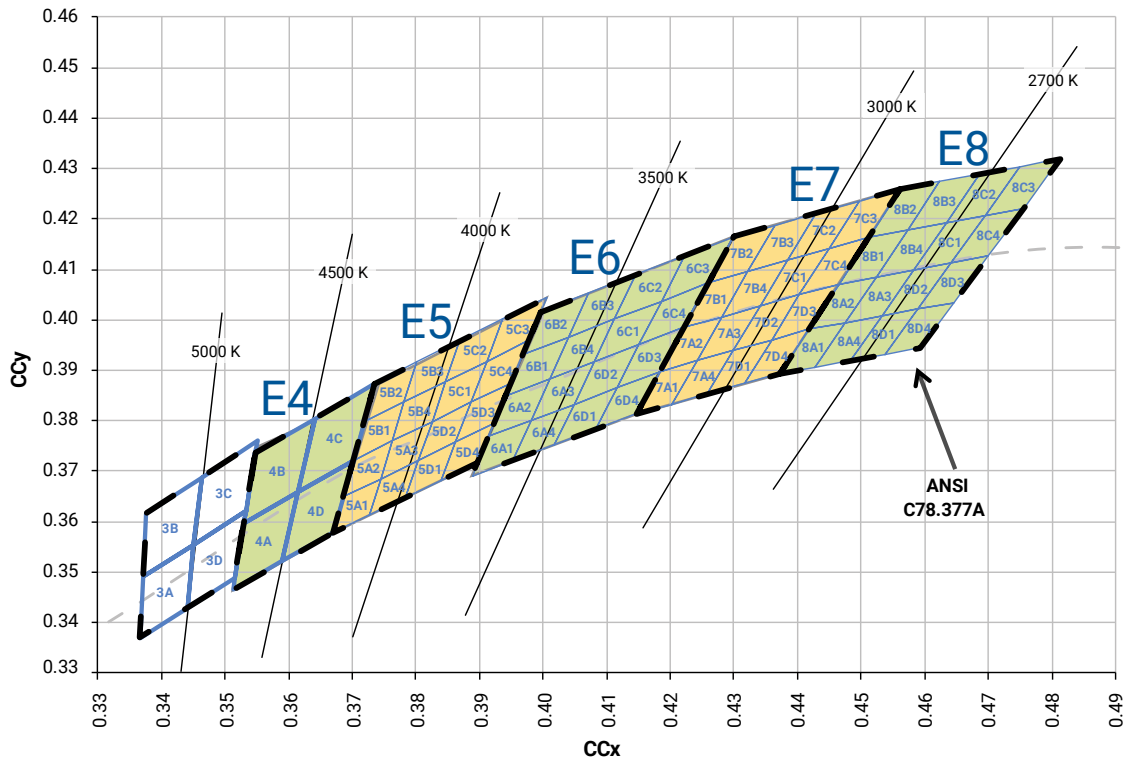

STANDARD WARM AND NEUTRAL WHITE KITS PLOTTED ON ANSI STANDARD CHROMATICITY REGIONS - CONTINUED

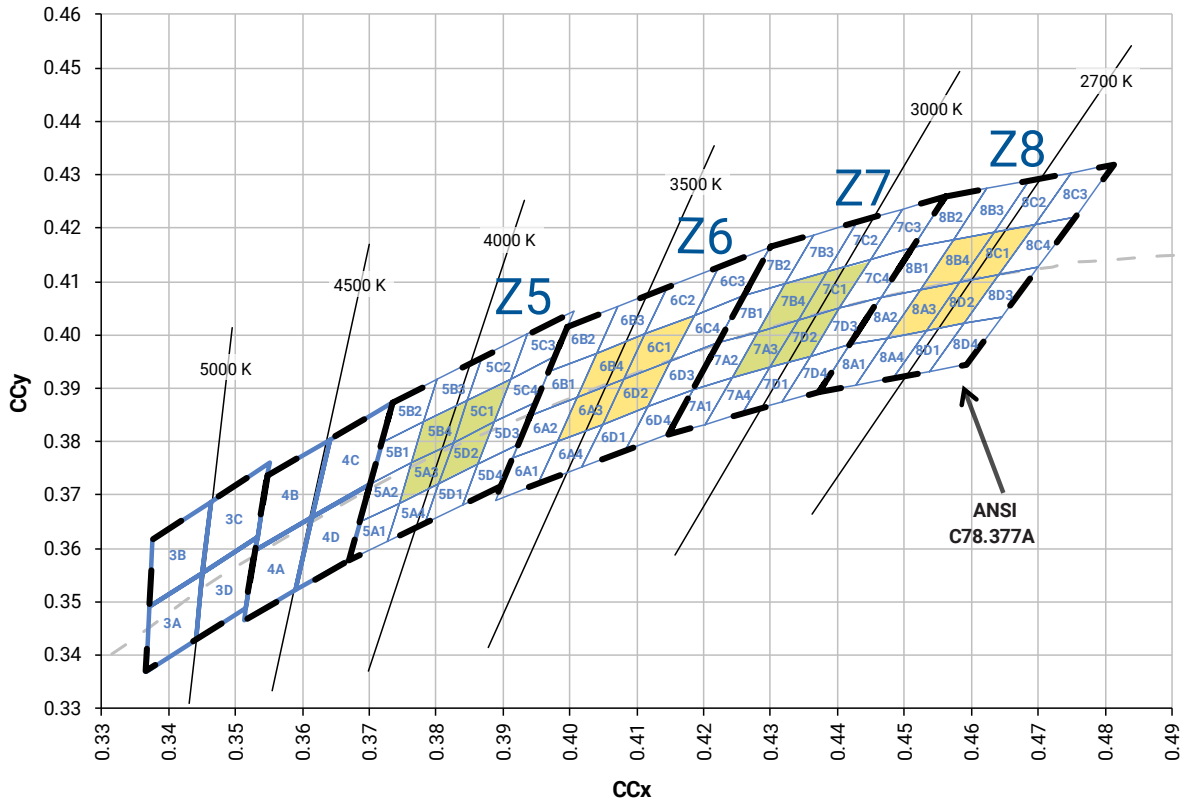

STANDARD CHROMATICITY KITS

The following table provides the chromaticity bins associated with chromaticity kits for the ML-E LEDs.

Color	CCT	Kit	Chromaticity Bins
Cool White	7000 K	DT	0A, 0B, 0C, 0D, 0R, 0S, 0T, 0U, 1A, 1B, 1C, 1D, 1R, 1S, 1T, 1U
	7000 K	E0	0A, 0B, 0C, 0D
	6500 K	S1	0A, 0B, 0C, 0D, 0R, 0S, 0T, 0U, 1A, 1B, 1C, 1D, 1R, 1S, 1T, 1U, 2A, 2B, 2C, 2D, 2R, 2S, 2T, 2U, 3A, 3B, 3R, 3S
	6500 K	E1	1A, 1B, 1C, 1D
	6200 K	S0	1A, 1B, 1C, 1D, 2A, 2B, 2C, 2D
	6000 K	DV	1A, 1B, 1C, 1D, 1R, 1S, 1T, 1U, 2A, 2B, 2C, 2D, 2R, 2S, 2T, 2U
	5700 K	E2	2A, 2B, 2C, 2D
	5500 K	DY	2A, 2B, 2C, 2D, 2R, 2S, 2T, 2U, 3A, 3B, 3C, 3D, 3R, 3S, 3T, 3U
	5000 K	DZ	2C, 2D, 2T, 2U, 3A, 3B, 3C, 3D, 3R, 3S, 3T, 3U, 4A, 4B, 4R, 4S
	5000 K	E3	3A, 3B, 3C, 3D
	4750 K	F4	3C, 3D, 4A, 4B
	4500 K	E4	4A, 4B, 4C, 4D
Warm White	4250 K	F5	4C, 4D, 5A1, 5A2, 5A3, 5A4, 5B1, 5B2, 5B3, 5B4
	4000 K	E5	5A1, 5A2, 5A3, 5A4, 5B1, 5B2, 5B3, 5B4, 5C1, 5C2, 5C3, 5C4, 5D1, 5D2, 5D3, 5D4
	4000 K	Z5	5A3, 5B4, 5C1, 5D2
	3750 K	F6	5C1, 5C2, 5C3, 5C4, 5D1, 5D2, 5D3, 5D4, 6A1, 6A2, 6A3, 6A4, 6B1, 6B2, 6B3, 6B4
	3500 K	E6	6A1, 6A2, 6A3, 6A4, 6B1, 6B2, 6B3, 6B4, 6C1, 6C2, 6C3, 6C4, 6D1, 6D2, 6D3, 6D4
	3500 K	Z6	6A3, 6B4, 6C1, 6D2
	3250 K	F7	6C1, 6C2, 6C3, 6C4, 6D1, 6D2, 6D3, 6D4, 7A1, 7A2, 7A3, 7A4, 7B1, 7B2, 7B3, 7B4
	3000 K	E7	7A1, 7A2, 7A3, 7A4, 7B1, 7B2, 7B3, 7B4, 7C1, 7C2, 7C3, 7C4, 7D1, 7D2, 7D3, 7D4
	3000 K	Z7	7A3, 7B4, 7C1, 7D2
	2850 K	F8	7C1, 7C2, 7C3, 7C4, 7D1, 7D2, 7D3, 7D4, 8A1, 8A2, 8A3, 8A4, 8B1, 8B2, 8B3, 8B4
	2700 K	E8	8A1, 8A2, 8A3, 8A4, 8B1, 8B2, 8B3, 8B4, 8C1, 8C2, 8C3, 8C4, 8D1, 8D2, 8D3, 8D4
	2700 K	Z8	8A3, 8B4, 8C1, 8D2

BIN AND ORDER CODE FORMATS

Bin codes and order codes are configured in the following manner:

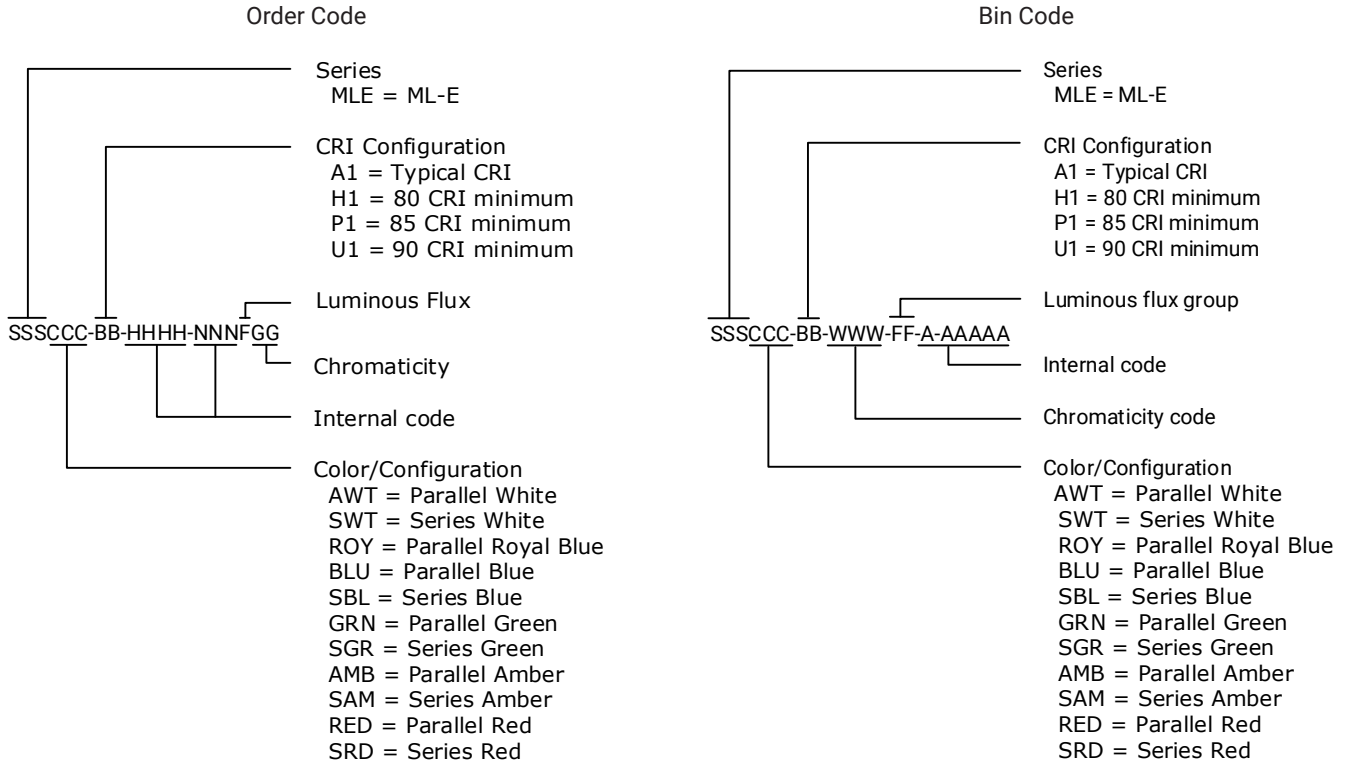

REFLOW SOLDERING CHARACTERISTICS

In testing, Cree LED has found XLamp ML-E LEDs to be compatible with JEDEC J-STD-020C, using the parameters listed below. As a general guideline, Cree LED recommends that users follow the recommended soldering profile provided by the manufacturer of the solder paste used, and therefore it is the lamp or luminaire manufacturer’s responsibility to determine applicable soldering requirements.

Note that this general guideline may not apply to all PCB designs and configurations of reflow soldering equipment.

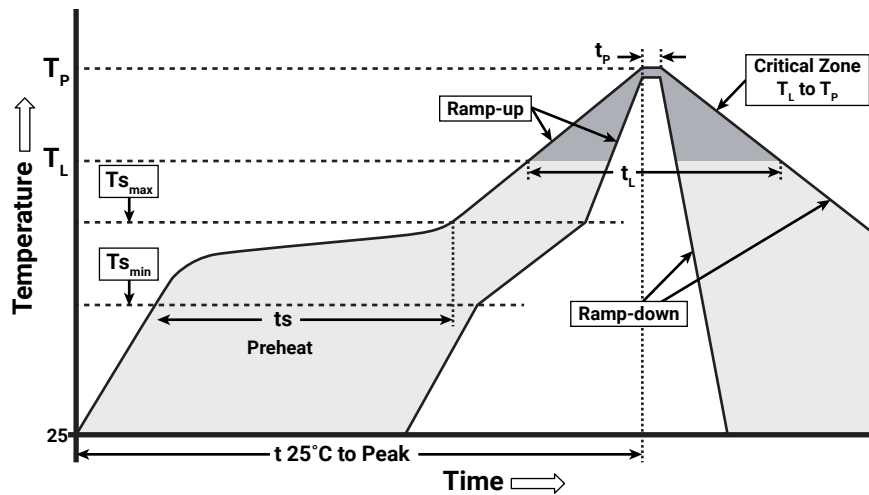

IPC/JEDEC J-STD-020C

Profile Feature	Lead-Free Solder
Average Ramp-Up Rate ($T_{s_{max}}$ to T_p)	1.2 °C/second
Preheat: Temperature Min ($T_{s_{min}}$)	120 °C
Preheat: Temperature Max ($T_{s_{max}}$)	170 °C
Preheat: Time ($t_{s_{min}}$ to $t_{s_{max}}$)	65-150 seconds
Time Maintained Above: Temperature (T_L)	217 °C
Time Maintained Above: Time (t_L)	45-90 seconds
Peak/Classification Temperature (T_p)	235 - 245 °C
Time Within 5 °C of Actual Peak Temperature (t_p)	20-40 seconds
Ramp-Down Rate	1 - 6 °C/second
Time 25 °C to Peak Temperature	4 minutes max.

Note: All temperatures refer to topside of the package, measured on the package body surface.

Note: While the high reflow temperatures (above) have been approved, Cree LED’s best practice guideline for reflow is to use as low a temperature as possible during the reflow soldering process for these LEDs.

NOTES

Measurements

The luminous flux, radiant power, chromaticity, forward voltage and CRI measurements in this document are binning specifications only and solely represent product measurements as of the date of shipment. These measurements will change over time based on a number of factors that are not within Cree LED's control and are not intended or provided as operational specifications for the products. Calculated values are provided for informational purposes only and are not intended or provided as specifications.

Pre-Release Qualification Testing

Please read the [LED Reliability Overview](#) for details of the qualification process Cree LED applies to ensure long-term reliability for XLamp LEDs and details of Cree LED's pre-release qualification testing for XLamp LEDs.

Lumen Maintenance

Cree LED now uses standardized IES LM-80-08 and TM-21-11 methods for collecting long-term data and extrapolating LED lumen maintenance. For information on the specific LM-80 data sets available for this LED, refer to the public [LM-80 results document](#).

Please read the [Long-Term Lumen Maintenance application note](#) for more details on Cree LED's lumen maintenance testing and forecasting. Please read the [Thermal Management application note](#) for details on how thermal design, ambient temperature, and drive current affect the LED junction temperature.

Moisture Sensitivity

Cree LED recommends keeping XLamp ML-E LEDs in the provided, resealable moisture-barrier packaging (MBP) until immediately prior to soldering. Unopened MBPs that contain XLamp LEDs do not need special storage for moisture sensitivity.

Once the MBP is opened, XLamp ML-E LEDs should be handled and stored as MSL 2a per JEDEC J-STD-033, meaning they have limited exposure time before damage to the LED may occur during the soldering operation. The table on the right specifies the maximum exposure time in days depending on temperature and humidity conditions. LEDs with exposure time longer than the specified maximums must be baked according to the baking conditions listed below.

Temp.	Maximum Percent Relative Humidity						
	30%	40%	50%	60%	70%	80%	90%
35 °C	-	-	-	17	1	.5	.5
30 °C	-	-	-	28	1	1	1
25 °C	-	-	-	-	2	1	1
20 °C	-	-	-	-	2	1	1

Baking Conditions

It is not necessary to bake all XLamp ML-E LEDs. Only the LEDs that meet all of the following criteria must be baked:

1. LEDs that have been removed from the original MBP.
2. LEDs that have been exposed to a humid environment longer than listed in the Moisture Sensitivity section above.
3. LEDs that have not been soldered.

NOTES - CONTINUED

LEDs should be baked at 70 °C for 24 hours. LEDs may be baked on the original reels. Remove LEDs from the MBP before baking. Do not bake parts at temperatures higher than 70 °C. This baking operation resets the exposure time as defined in the Moisture Sensitivity section above.

Storage Conditions

XLamp ML-E LEDs that have been removed from the original MBP but not soldered should be stored in one of the following ways:

- Store the parts in a rigid metal container with a tight-fitting lid. Verify that the storage temperature is <30 °C, and place fresh desiccant and an RH indicator in the container to verify that the RH is no greater than 60%.
- Store the parts in a dry, nitrogen-purged cabinet or container that actively maintains the temperature at <30° and the RH at no greater than 60%.
- For short-term store only: LEDs can be resealed in the original MBP soon after opening. Fresh desiccant may be needed. Use the included humidity indicator card to verify <60% RH.

If an environment of <60% RH is not available for storage, XLamp ML-E LEDs should be baked (described above) before reflow soldering.

RoHS Compliance

The levels of RoHS restricted materials in this product are below the maximum concentration values (also referred to as the threshold limits) permitted for such substances, or are used in an exempted application, in accordance with EU Directive 2011/65/EC (RoHS2), as implemented January 2, 2013. RoHS Declarations for this product can be obtained from your Cree LED representative or from the [Product Ecology](#) section of the Cree LED website.

REACH Compliance

REACH substances of very high concern (SVHCs) information is available for this product. Since the European Chemical Agency (ECHA) has published notice of their intent to frequently revise the SVHC listing for the foreseeable future, please contact a Cree LED representative to insure you get the most up-to-date REACH SVHC Declaration. REACH banned substance information (REACH Article 67) is also available upon request.

UL® Recognized Component

This product meets the requirements to be considered a UL Recognized Component with Level 4 enclosure consideration. The LED package or a portion thereof has been investigated as a fire and electrical enclosure per ANSI/UL 8750.

Vision Advisory

WARNING: Do not look at an exposed lamp in operation. Eye injury can result. For more information about LEDs and eye safety, please refer to the [LED Eye Safety application note](#).

MECHANICAL DIMENSIONS ($T_A = 25\text{ }^\circ\text{C}$)

All measurements are ± 0.13 mm unless otherwise indicated.

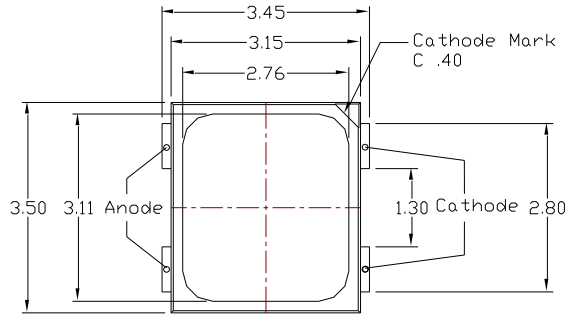
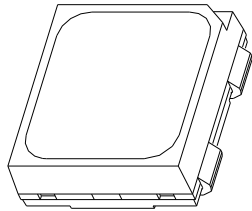

Top View

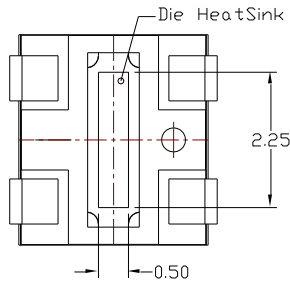

Bottom View

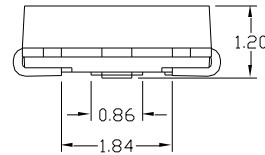

Side View

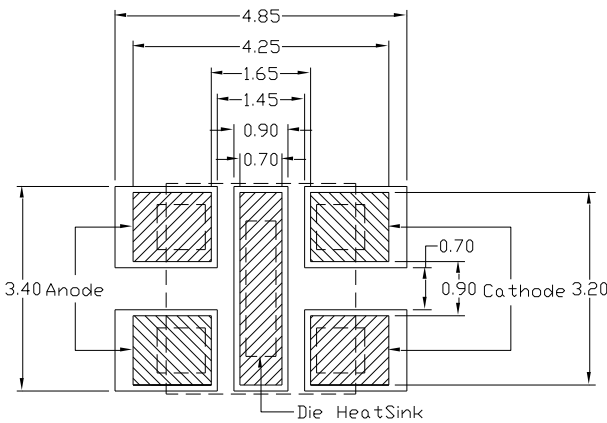

Recommended PCB Solder Pad

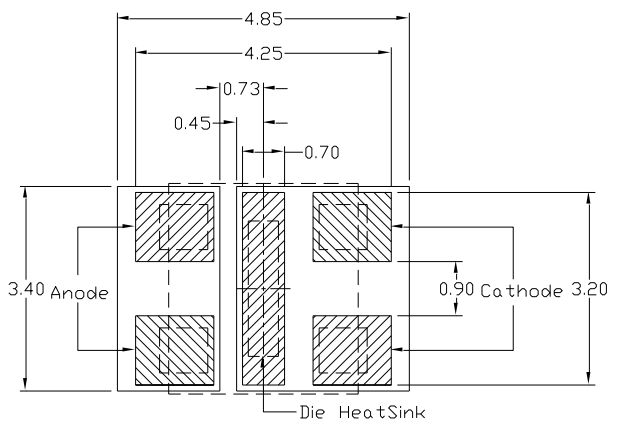

Alternate Solder Pad

MECHANICAL DIMENSIONS (T_A = 25 °C) - CONTINUED

All measurements are ±.13 mm unless otherwise indicated.

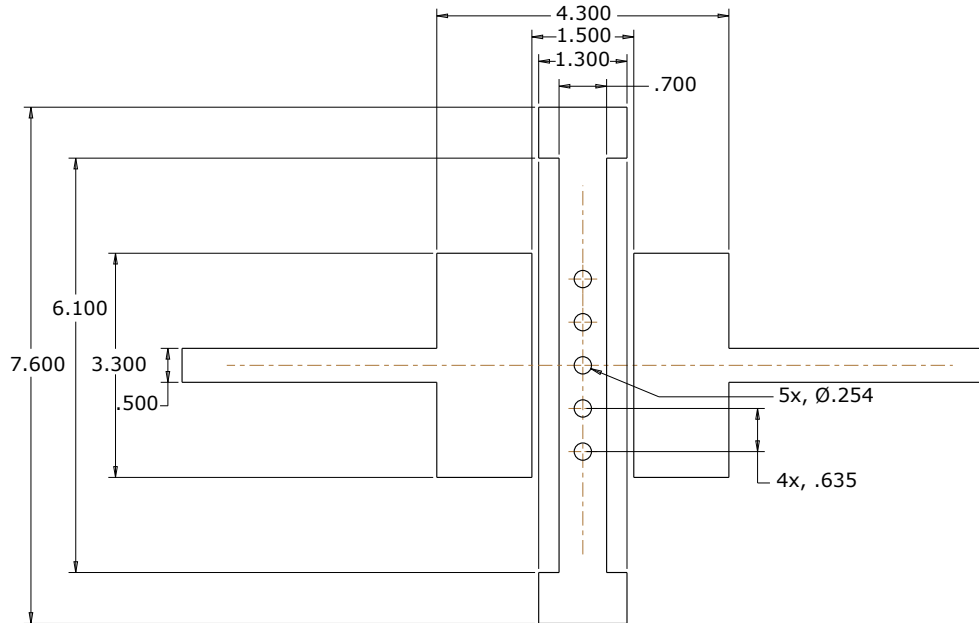

Recommended FR4 Solder Pad with Thermal Vias

TAPE AND REEL

All Cree LED carrier tapes conform to EIA-481D, Automated Component Handling Systems Standard.

Except as noted, all dimensions in mm.

All measurements are ±.25 mm unless otherwise indicated.

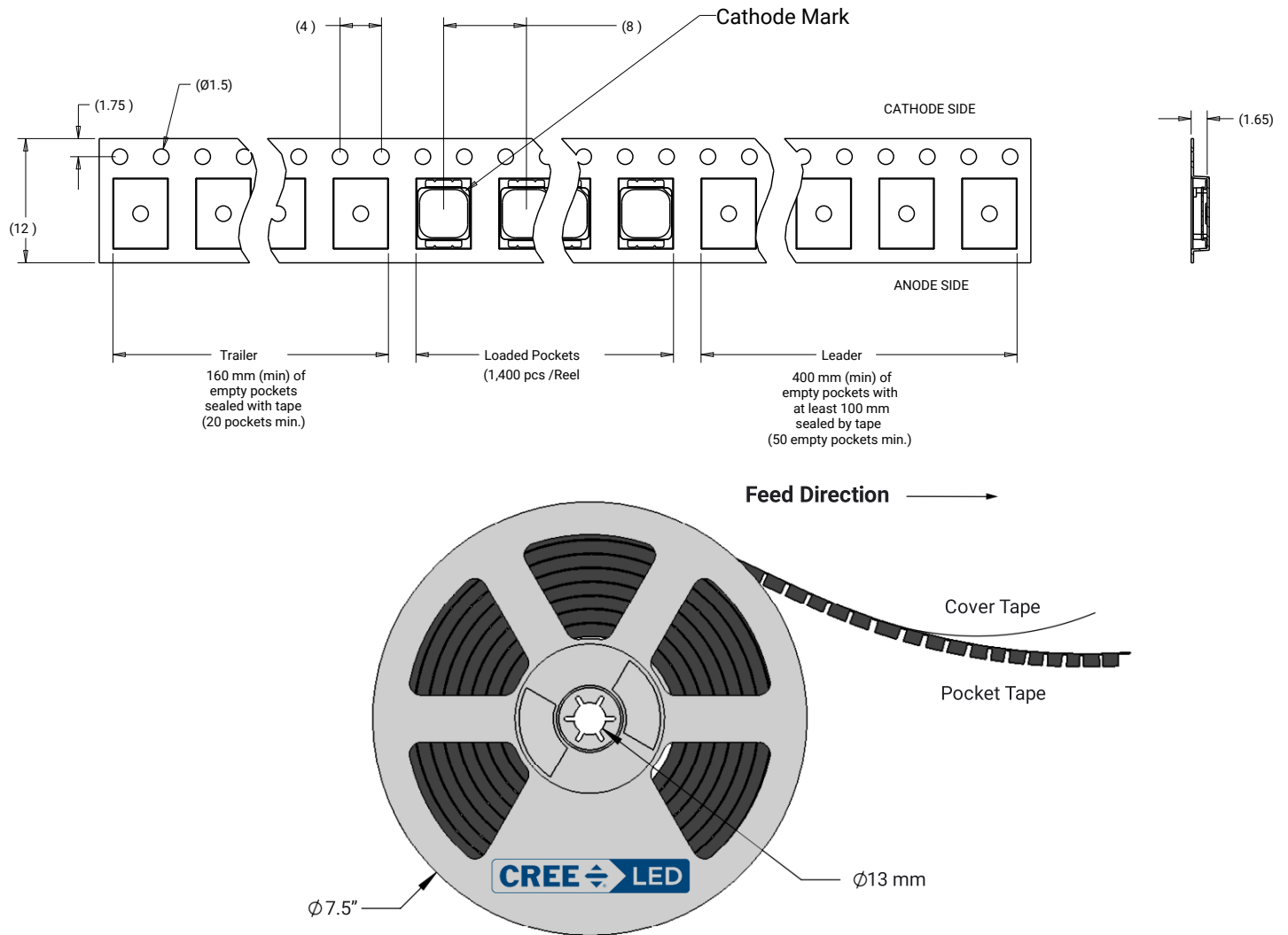

PACKAGING

Unpackaged Reel

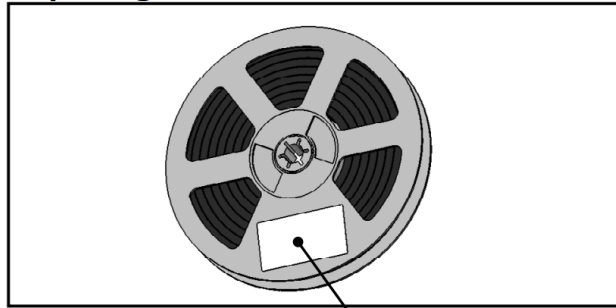

Label with Cree LED Bin Code, Quantity, Reel ID

Packaged Reel

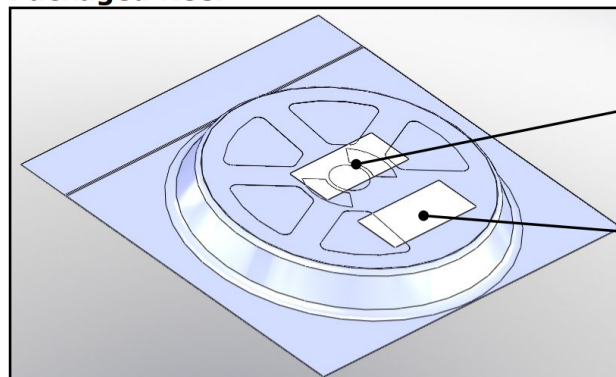

Label with Cree LED Order Code, Quantity, Reel ID, PO#

Label with Cree LED Bin Code, Quantity, Reel ID

Boxed Reel

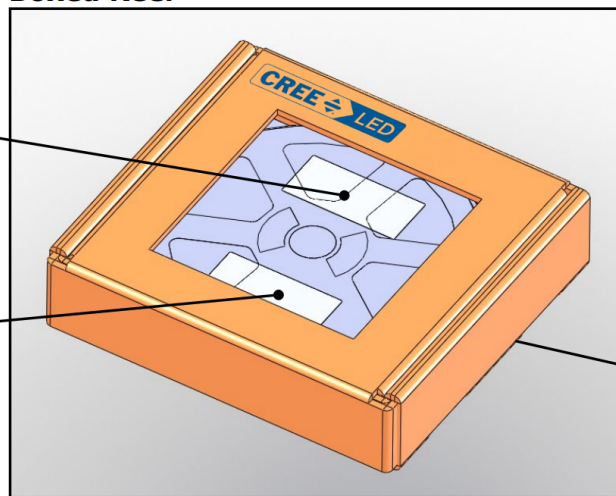

Label with Cree LED Order Code, Quantity, Reel ID, PO#

Label with Cree LED Bin Code, Quantity, Reel ID

Patent Label (on bottom of box)

Looking for pricing, stock, or lifecycle information?

Click below to explore more details on WIN SOURCE:

- ⊖ [View MLEAWT-A1-0000-0004DY on WIN SOURCE](#)
- ⊖ [CreeLED, Inc. Information](#)

Optimize Your Supply Chain with WIN SOURCE Solutions

- ✓ Global Sourcing Solution
- ✓ Obsolete Management
- ✓ Cost Control Management
- ✓ Shortage Management
- ✓ Alternative Solution
- ✓ Excess Inventory Management