



**THE DATASHEET OF**  
**4304H7**





# 4304H Series Solid State LED Lamps T-1 3/4 (5mm)



## Key Features

- Low power consumption
- T-1 3/4 diameter package
- 4 colors available: red, amber, green and yellow
- Long life - solid state reliability
- Reliable and rugged

## Product Dimensions

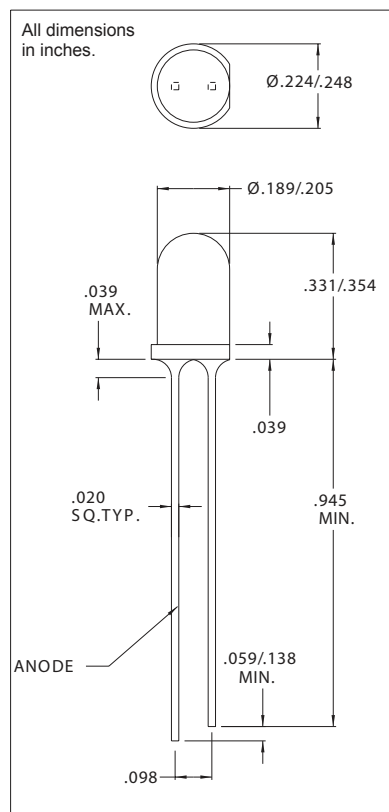

# Product Specifications

PART NUMBER	4304H1	4304H3	4304H5	4304H7
Output Color	Red	Amber	Green	Yellow
Diffusion	Diffused	Diffused	Diffused	Diffused
Package Color	Red	Amber	Green	Yellow
Test Current (mA)	10	10	10	10
Forward Voltage Typ. (V)	2.0	1.9	2.1	2.1
Luminous Intensity Min. (mcd)	3.6	3.8	5.6	5.6
Luminous Intensity Typ. (mcd)	10	-	16	16
Luminous Intensity Max. (mcd)	-	9.7	-	-
Dominant Wavelength (nm)	630	602	572	585
Viewing Angle 20 1/2 (degrees)	40	60	40	40
Power Dissipation (mW)	60	135	75	60
Reverse Voltage (V)	3	5	3	3

## Electrical Characteristics Curves

Forward current vs. forward voltage

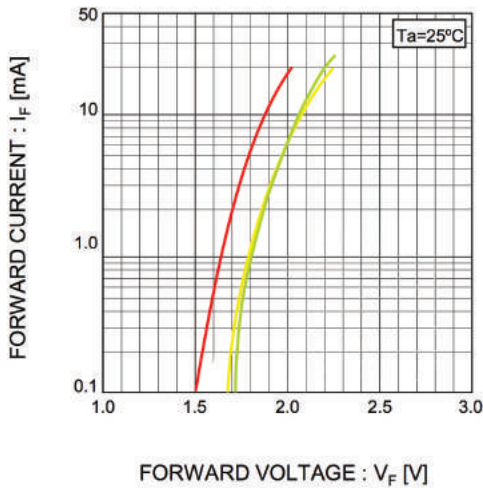

- 4304H1
- 4304H5
- 4304H7

Luminous Intensity vs. Atmosphere Temperature

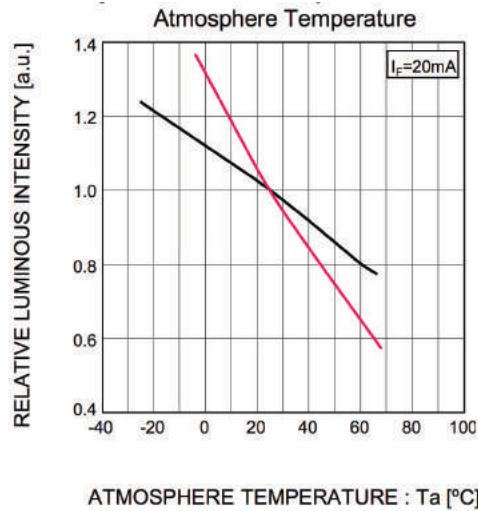

- 4304H1, 4304H5
- 4304H7

Luminous Intensity vs. Forward Current

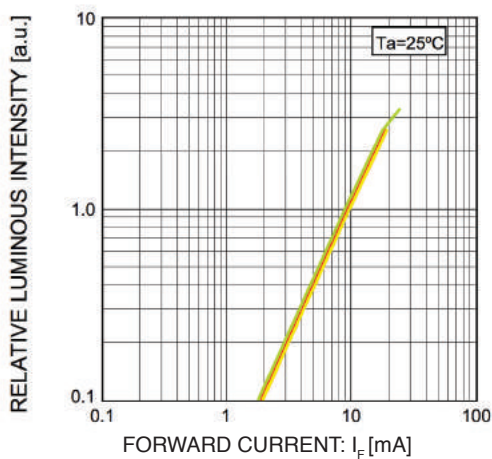

- 4304H1
- 4304H5
- 4304H7

Derating

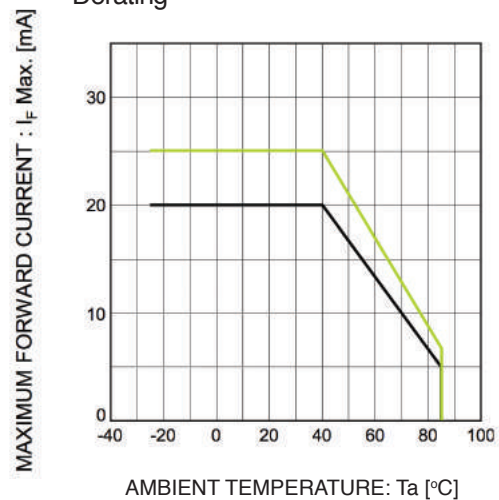

- 4304H1, 4304H7
- 4304H5

# Electrical Characteristics Curves

Color: Amber (4304H3)

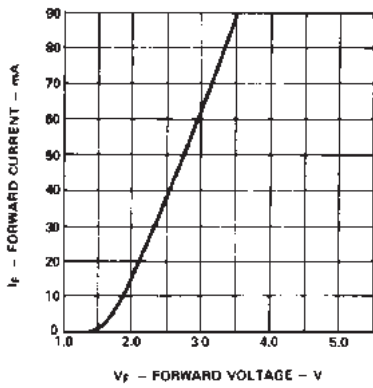

Forward current vs. forward voltage characteristics

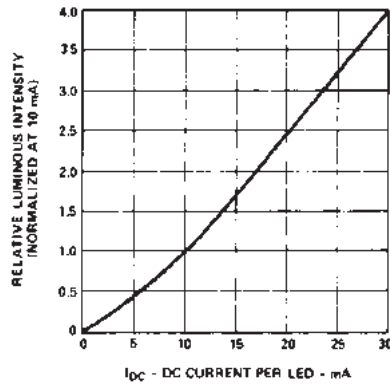

Relative luminous intensity vs. DC forward current

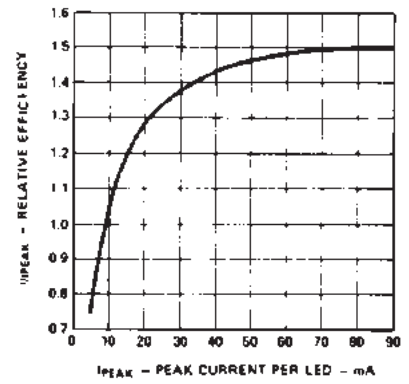

Relative efficiency (luminous intensity per unit current) vs. peak LED current

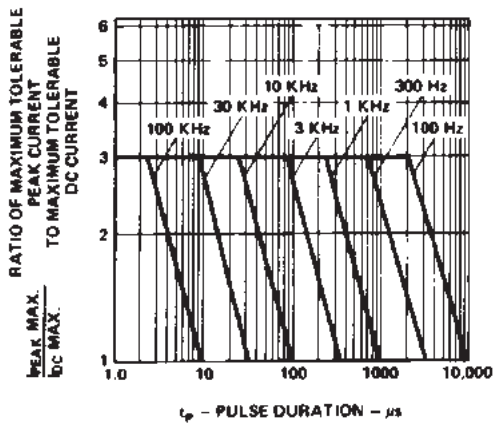

Maximum tolerable peak current vs. pulse duration. ( $I_{DC}$  MAX as per MAX ratings)

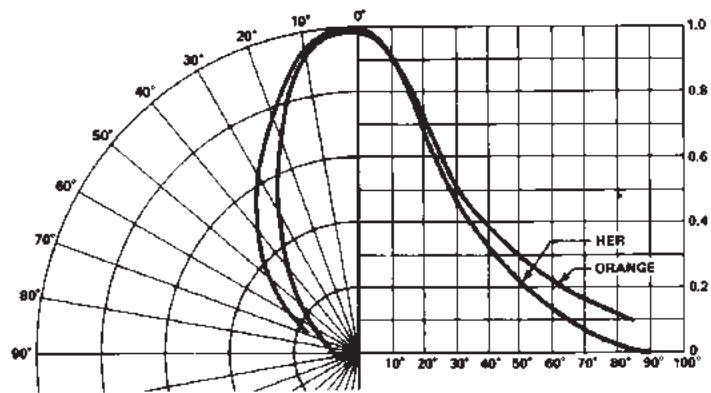

Relative luminous intensity vs. angular displacement

## Compliances and Approvals









## Looking for pricing, stock, or lifecycle information?

Click below to explore more details on WIN SOURCE:

-  [View 4304H7 on WIN SOURCE](#)
-  [Visual Communications Company - VCC Information](#)

## Optimize Your Supply Chain with WIN SOURCE Solutions

-  Global Sourcing Solution
-  Obsolete Management
-  Cost Control Management
-  Shortage Management
-  Alternative Solution
-  Excess Inventory Management