



THE DATASHEET OF
4303F1





4303F Series Solid State LED T1 (3mm)

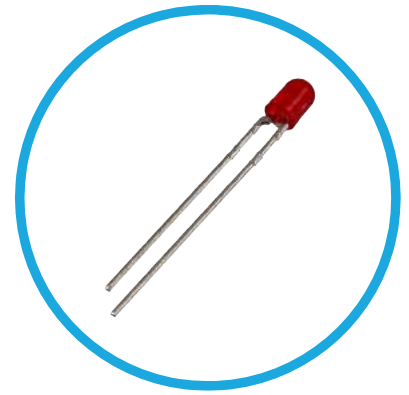

Applications

- advertising
- appliances
- automotive
- aviation
- boating and recreation
- display cases
- electrical control panels
- general illumination
- “high-tech” applications
- home and landscape
- signs, signals and displays
- traffic signals

Key Features

- diffused lens
- high intensity light output
- low power dissipation
- solid state LED lamp

Product Specifications and Ordering Data

Part Number	4303F1	4303F3	4303F5	4303F7
Output Color	Red	Amber	Green	Yellow
Diffusion	Diffused	Diffused	Diffused	Diffused
Package Color	Red	Amber	Green	Yellow
Test Current (mA)	10	10	10	10
Forward Voltage Typ. (V)	2.0	1.9	2.1	2.1
Forward Voltage Max. (V)	3.0	2.4	3.0	3.0
Luminous Intensity Min. (mcd)	5.6	2.1	9.0	3.6
Luminous Intensity Typ. (mcd)	16.0	-	25.0	10.0
Peak Wavelength (nm)	650	600	563	585
Viewing Angle θ 1/2 (degrees)	55	60	55	55
Power Dissipation (mW)	60	-	75	60
Peak Forward Current Max @1ms - 20% Duty Cycle (mA)	60	90	60	60
Reverse Voltage @ $I_R=100\mu A$	3	5	3	3
Operating Temperature (°C)	-25 to +85	-40 to +100	-25 to +85	-25 to +85
Storage Temperature (°C)	-30 to +100	-40 to +100	-30 to +100	-30 to +100

Product Dimensions

All dimensions are in mm

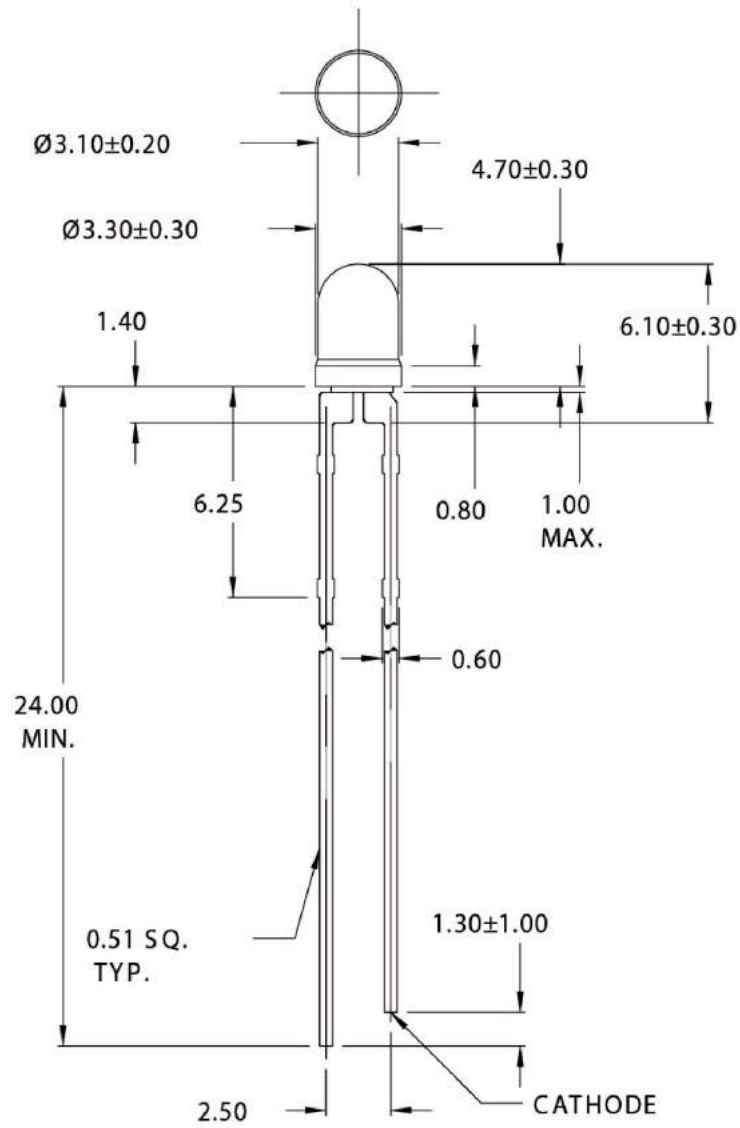

Compliances and Approvals



Looking for pricing, stock, or lifecycle information?

Click below to explore more details on WIN SOURCE:

-  [View 4303F1 on WIN SOURCE](#)
-  [Visual Communications Company - VCC Information](#)

Optimize Your Supply Chain with WIN SOURCE Solutions

-  Global Sourcing Solution
-  Obsolete Management
-  Cost Control Management
-  Shortage Management
-  Alternative Solution
-  Excess Inventory Management