



**THE DATASHEET OF
PSR400ITQFJ2L00**



●Feature

- 1) High power max 15W
- 2) Ultra low resistance range (0.1mΩ or more).
- 3) Excellent TCR characteristic
- 4) Convex structure
- 5) ROHM resistors have obtained ISO9001 / IATF16949 certification.
- 6) Corresponds to AEC-Q200.

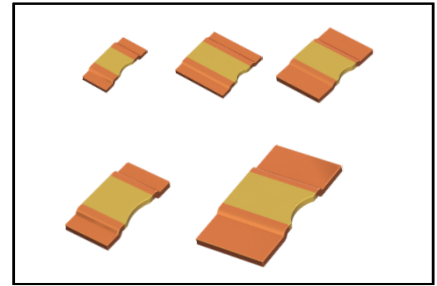

●Products list

Part No.	Size		Resistance (mΩ)	Tolerance	Special code	Rated power P (Rated terminal temperature T _k)		Temperature coefficient (ppm/°C)	Operating temperature range (°C)	Automotive grade available (AEC-Q200)
	(mm)	(inch)								
PSR100	6432	2512	☆0.2	F(±1%)	C	12W(120°C)		150±50	-65 ~+175	Yes
			0.3		D	8W(75°C)	4W(140°C)	0 ~+150		
			0.5		F	8W(75°C)	4W(140°C)	0 ~+100		
			1.0		H	8W(75°C)	4W(140°C)	0 ~+50		
			2.0		J	6W(75°C)	4W(140°C)			
			3.0		L	4W(75°C)	3W(140°C)			
☆PSR330	6464	2525	0.1	F(±1%)	B	15W(120°C)		100±50	-65 ~+175	Yes
			0.5		F	8W(100°C)		0 ~+100		
			1.0		H	6W(100°C)		0 ~+50		
New PSR350	7.9×5.6	3222	0.27	F(±1%)	CW	12W(120°C)		0~+150	-65 ~+175	Yes
PSR400	10×5.2	3921	0.2	F(±1%)	C	12W(75°C)	5W(130°C)	125±50	-65 ~+175	Yes
			0.3		D	10W(75°C)	5W(130°C)	0 ~+100		
			0.5		F	10W(75°C)	5W(130°C)	0 ~+75		
			1.0		H	8W(75°C)	5W(130°C)			
			2.0		J	6W(75°C)	4W(115°C)			
			3.0		L	5W(70°C)	3W(115°C)			
PSR500	15×7.75	5931	0.1	F(±1%)	B	15W(75°C)	10W(120°C)	200 ±50	-65 ~+175	Yes
			0.2		C	15W(75°C)	10W(120°C)	0 ~+150		
			0.3		D	10W(75°C)	7W(120°C)	0 ~+150		
			0.4		E	10W(75°C)	7W(120°C)	0 ~+75		
			0.5		F	10W(75°C)	7W(120°C)			
			1.0		H	10W(75°C)	6W(120°C)			
			2.0		J	7W(70°C)	4W(115°C)			

☆ : Under development

Design and specifications are subject to change without notice.

Carefully check the specification sheet supplied with the product before using or ordering it.

●Part number description

PSR	100	KTQ	F	H	1L00																																																																																																		
<table border="1"> <tr><th>Part No.</th></tr> <tr><td>PSR</td></tr> <tr><td>High power metal plate shunt resistors <Ultra low ohmic></td></tr> </table>	Part No.	PSR	High power metal plate shunt resistors <Ultra low ohmic>	<table border="1"> <tr><th>Size</th><th>(mm)</th><th>[inch]</th></tr> <tr><td>100</td><td>(6432)</td><td>[2512]</td></tr> <tr><td>330</td><td>(6464)</td><td>[2525]</td></tr> <tr><td>350</td><td>(7.9×5.6)</td><td>[3222]</td></tr> <tr><td>400</td><td>(10×5.2)</td><td>[3921]</td></tr> <tr><td>500</td><td>(15×7.75)</td><td>[5931]</td></tr> </table>	Size	(mm)	[inch]	100	(6432)	[2512]	330	(6464)	[2525]	350	(7.9×5.6)	[3222]	400	(10×5.2)	[3921]	500	(15×7.75)	[5931]	<table border="1"> <tr><th colspan="4">Packaging specifications code</th></tr> <tr><th>Part No.</th><th>Code</th><th>Packaging specification</th><th>Quantity pcs/Reel</th></tr> <tr><td rowspan="2">PSR100</td><td>ITQ^{*1}</td><td>Embossed tape (8mm Pitch)</td><td>3,000</td></tr> <tr><td>KTQ^{*2}</td><td>Embossed tape (8mm pitch)</td><td>5,000</td></tr> <tr><td>PSR330</td><td>ITQ</td><td>Embossed tape (8mm pitch)</td><td>3,000</td></tr> <tr><td>PSR350</td><td>KTQ</td><td>Embossed tape (8mm Pitch)</td><td>5,000</td></tr> <tr><td>PSR400</td><td>ITQ</td><td>Embossed tape (8mm Pitch)</td><td>3,000</td></tr> <tr><td>PSR500</td><td>HTQ</td><td>Embossed tape (8mm Pitch)</td><td>2,000</td></tr> </table>	Packaging specifications code				Part No.	Code	Packaging specification	Quantity pcs/Reel	PSR100	ITQ ^{*1}	Embossed tape (8mm Pitch)	3,000	KTQ ^{*2}	Embossed tape (8mm pitch)	5,000	PSR330	ITQ	Embossed tape (8mm pitch)	3,000	PSR350	KTQ	Embossed tape (8mm Pitch)	5,000	PSR400	ITQ	Embossed tape (8mm Pitch)	3,000	PSR500	HTQ	Embossed tape (8mm Pitch)	2,000	<table border="1"> <tr><th>Resistance tolerance</th></tr> <tr><td>F (±1%)</td></tr> </table>	Resistance tolerance	F (±1%)	<table border="1"> <tr><th colspan="2">Special part code</th></tr> <tr><td>B</td><td>0.1mΩ</td></tr> <tr><td>C</td><td>0.2mΩ</td></tr> <tr><td>CW^{*3}</td><td>0.27mΩ</td></tr> <tr><td>D</td><td>0.3mΩ</td></tr> <tr><td>E</td><td>0.4mΩ</td></tr> <tr><td>F</td><td>0.5mΩ</td></tr> <tr><td>H</td><td>1.0mΩ</td></tr> <tr><td>J</td><td>2.0mΩ</td></tr> <tr><td>L</td><td>3.0mΩ</td></tr> </table> <p>*3 : Only PSR350</p>	Special part code		B	0.1mΩ	C	0.2mΩ	CW ^{*3}	0.27mΩ	D	0.3mΩ	E	0.4mΩ	F	0.5mΩ	H	1.0mΩ	J	2.0mΩ	L	3.0mΩ	<table border="1"> <tr><th colspan="2">Nominal resistance</th></tr> <tr><td colspan="2">Resistance code, 4 digits</td></tr> <tr><td>Resistance</td><td>4 digits</td></tr> <tr><td>0.1mΩ</td><td>0L10</td></tr> <tr><td>0.2mΩ</td><td>0L20</td></tr> <tr><td>0.27mΩ</td><td>0L27</td></tr> <tr><td>0.3mΩ</td><td>0L30</td></tr> <tr><td>0.4mΩ</td><td>0L40</td></tr> <tr><td>0.5mΩ</td><td>0L50</td></tr> <tr><td>1.0mΩ</td><td>1L00</td></tr> <tr><td>2.0mΩ</td><td>2L00</td></tr> <tr><td>3.0mΩ</td><td>3L00</td></tr> </table>	Nominal resistance		Resistance code, 4 digits		Resistance	4 digits	0.1mΩ	0L10	0.2mΩ	0L20	0.27mΩ	0L27	0.3mΩ	0L30	0.4mΩ	0L40	0.5mΩ	0L50	1.0mΩ	1L00	2.0mΩ	2L00	3.0mΩ	3L00
Part No.																																																																																																							
PSR																																																																																																							
High power metal plate shunt resistors <Ultra low ohmic>																																																																																																							
Size	(mm)	[inch]																																																																																																					
100	(6432)	[2512]																																																																																																					
330	(6464)	[2525]																																																																																																					
350	(7.9×5.6)	[3222]																																																																																																					
400	(10×5.2)	[3921]																																																																																																					
500	(15×7.75)	[5931]																																																																																																					
Packaging specifications code																																																																																																							
Part No.	Code	Packaging specification	Quantity pcs/Reel																																																																																																				
PSR100	ITQ ^{*1}	Embossed tape (8mm Pitch)	3,000																																																																																																				
	KTQ ^{*2}	Embossed tape (8mm pitch)	5,000																																																																																																				
PSR330	ITQ	Embossed tape (8mm pitch)	3,000																																																																																																				
PSR350	KTQ	Embossed tape (8mm Pitch)	5,000																																																																																																				
PSR400	ITQ	Embossed tape (8mm Pitch)	3,000																																																																																																				
PSR500	HTQ	Embossed tape (8mm Pitch)	2,000																																																																																																				
Resistance tolerance																																																																																																							
F (±1%)																																																																																																							
Special part code																																																																																																							
B	0.1mΩ																																																																																																						
C	0.2mΩ																																																																																																						
CW ^{*3}	0.27mΩ																																																																																																						
D	0.3mΩ																																																																																																						
E	0.4mΩ																																																																																																						
F	0.5mΩ																																																																																																						
H	1.0mΩ																																																																																																						
J	2.0mΩ																																																																																																						
L	3.0mΩ																																																																																																						
Nominal resistance																																																																																																							
Resistance code, 4 digits																																																																																																							
Resistance	4 digits																																																																																																						
0.1mΩ	0L10																																																																																																						
0.2mΩ	0L20																																																																																																						
0.27mΩ	0L27																																																																																																						
0.3mΩ	0L30																																																																																																						
0.4mΩ	0L40																																																																																																						
0.5mΩ	0L50																																																																																																						
1.0mΩ	1L00																																																																																																						
2.0mΩ	2L00																																																																																																						
3.0mΩ	3L00																																																																																																						

*1 ITQ : Apply to 0.2mΩ

*2 KTQ : Apply to 0.3mΩ~3.0mΩ

● Chip resistor dimensions and materials

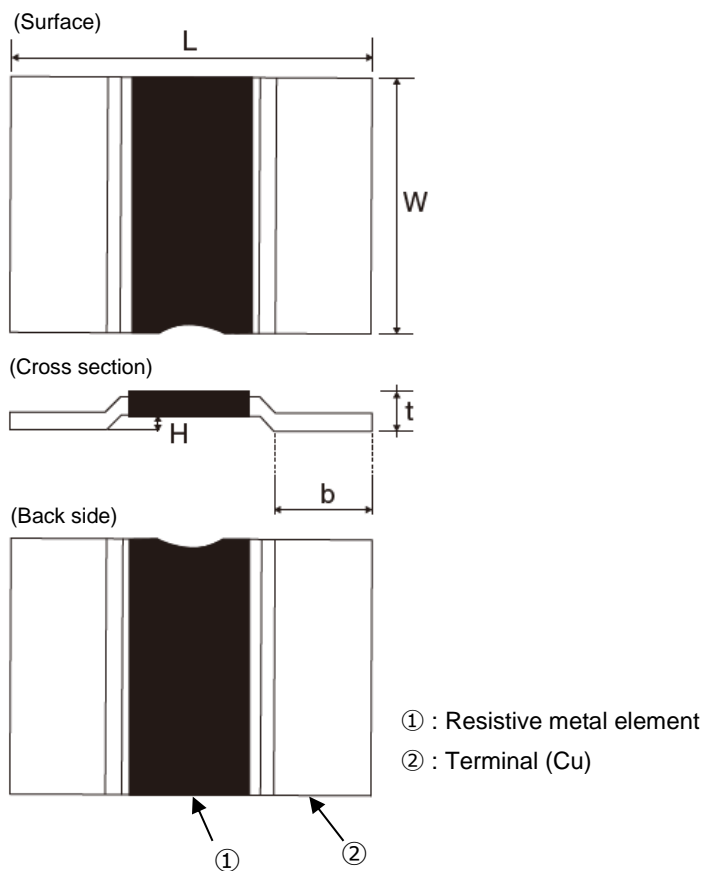

(Unit : mm)

Part No.	Resistance	L	W	t	H	b	Resistive metal element
PSR100	0.2mΩ	6.35±0.15	3.05±0.25	1.80±0.15	0.35±0.15	1.12±0.3	Cu-Mn-Sn
	0.3mΩ			1.45±0.15			
	0.5mΩ			1.15±0.15			
	1.0mΩ			0.75±0.15			Cu-Mn
	2.0mΩ			1.00±0.15			
	3.0mΩ			0.75±0.15			
PSR330	0.1mΩ	6.35±0.15	6.35±0.15	1.81±0.15	0.35±0.15	1.12±0.3	Cu-Mn-Sn
	0.5mΩ			0.75±0.15			Cu-Mn
	1.0mΩ			1.00±0.15			Ni-Cr
PSR350	0.27mΩ	7.9±0.1	5.6±0.3	0.85±0.15	0.35±0.15	2.1±0.2	Cu-Mn-Sn
PSR400	0.2mΩ	10.0±0.3	5.2±0.3	1.90±0.15	0.5±0.15	2.0±0.6	Cu-Mn-Sn
	0.3mΩ			1.85±0.15			
	0.5mΩ			1.30±0.15			Cu-Mn
	1.0mΩ			0.90±0.15			
	2.0mΩ			1.10±0.15			
	3.0mΩ			0.90±0.15			Ni-Cr
PSR500	0.1mΩ	15.0±0.3	7.75±0.3	1.96±0.15	0.5±0.15	4.0±0.6	Cu-Mn-Sn
	0.2mΩ			1.85±0.15			
	0.3mΩ			1.40±0.15			
	0.4mΩ			1.15±0.15			Cu-Mn
	0.5mΩ			1.05±0.15			
	1.0mΩ			1.35±0.15			
	2.0mΩ			0.90±0.15			Ni-Cr

●Land pattern example

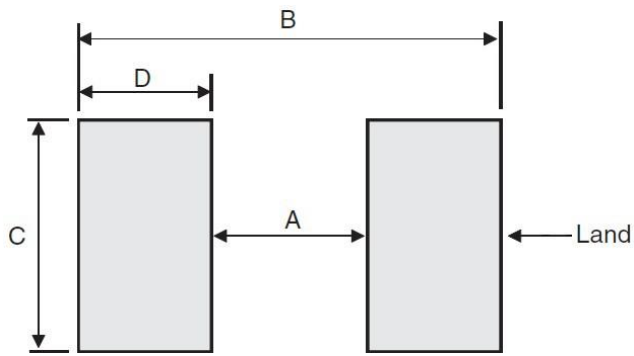

(Unit : mm)

Part No.	A	B	C	D
PSR100	3.40	7.00	3.40	1.80
PSR330	3.40	7.00	6.70	1.80
PSR350	3.50	8.70	5.80	2.60
PSR400	5.60	11.00	6.20	2.70
PSR500	5.60	16.00	8.75	5.20

● **Derating curve**

When the each rated terminal temperature exceeds , power dissipation must be adjusted according to the derating curve below Fig.2. ~ Fig.24.

The measurement part of terminal temperature is center of the terminal with load.

(Measuring part of terminal temperature, see Fig.1)

Fig.1 Part of measuring terminal temperature

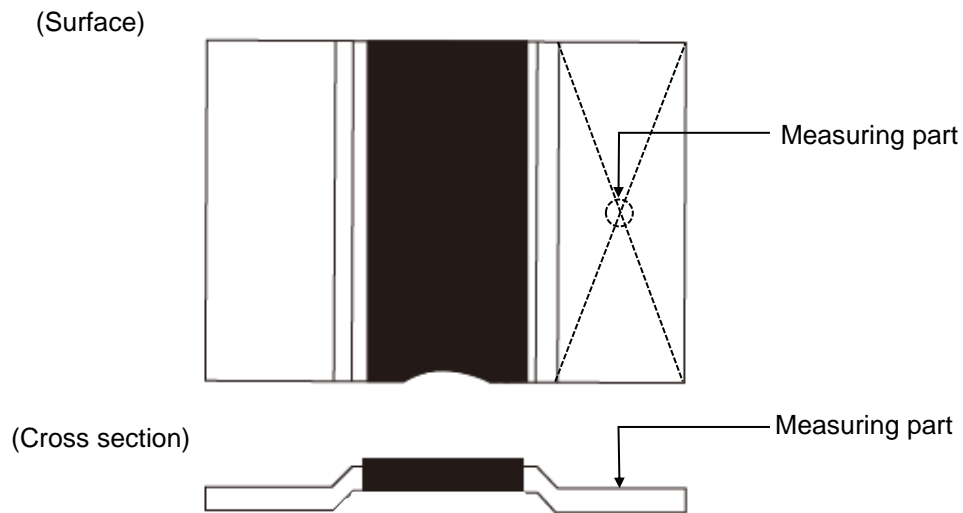

■PSR100

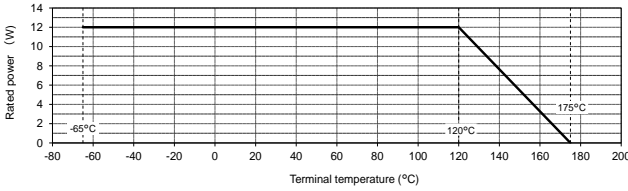
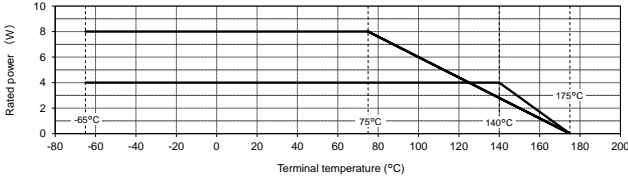
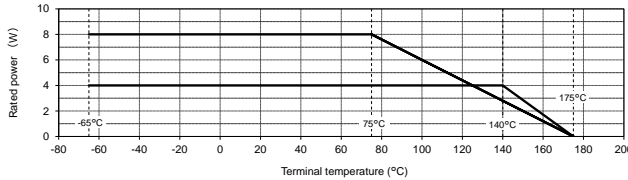
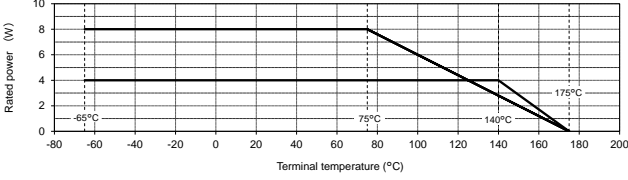
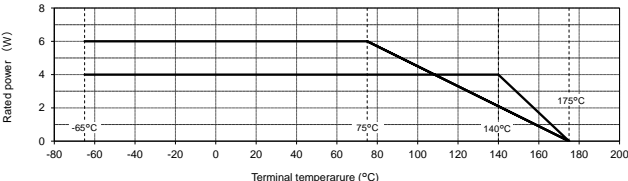
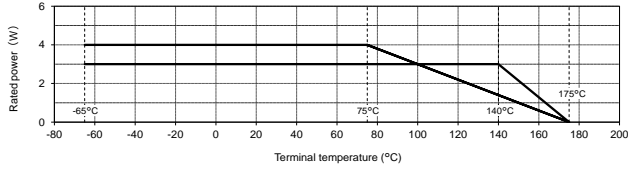
Items	Conditions	Specifications
Rated power 0.2mΩ	When the terminal temperature exceeds 120°C, the load shall be derated in accordance with Fig.2 	P _{120°C} =12W at -65 ~ 120°C (Terminal temperature)
Rated power 0.3mΩ	When the terminal temperature exceeds 75°C and 140°C, the load shall be derated in accordance with Fig.3 	P _{75°C} =8W at -65 ~ 75°C (Terminal temperature)
		P _{140°C} =4W at -65 ~ 140°C (Terminal temperature)
Rated power 0.5mΩ	When the terminal temperature exceeds 75°C and 140°C, the load shall be derated in accordance with Fig.4 	P _{75°C} =8W at -65 ~ 75°C (Terminal temperature)
		P _{140°C} =4W at -65 ~ 140°C (Terminal temperature)
Rated power 1.0mΩ	When the terminal temperature exceeds 75°C and 140°C, the load shall be derated in accordance with Fig.5 	P _{75°C} =8W at -65 ~ 75°C (Terminal temperature)
		P _{140°C} =4W at -65 ~ 140°C (Terminal temperature)
Rated power 2.0mΩ	When the terminal temperature exceeds 75°C and 140°C, the load shall be derated in accordance with Fig.6 	P _{75°C} =6W at -65 ~ 75°C (Terminal temperature)
		P _{140°C} =4W at -65 ~ 140°C (Terminal temperature)
Rated power 3.0mΩ	When the terminal temperature exceeds 75°C and 140°C, the load shall be derated in accordance with Fig.7 	P _{75°C} =4W at -65 ~ 75°C (Terminal temperature)
		P _{140°C} =3W at -65 ~ 140°C (Terminal temperature)
Rated voltage Rated current	Rated voltage and current are determined by the following formula. $E = \sqrt{P \times R}$ $I = \sqrt{P / R}$ E : Rated voltage (V) I : Rated current (A) P : Rated power (W) R : Resistance (Ω)	
Resistance	See P1	
Temperature		-65°C ~ +175°C

■PSR330

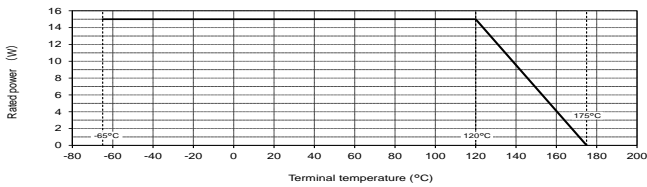
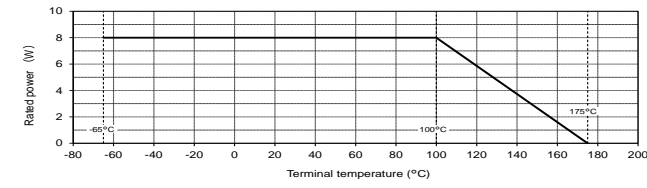
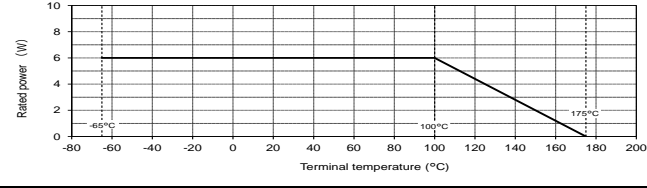
Items	Conditions	Specifications
Rated power 0.1mΩ	When the terminal temperature exceeds 120°C, the load shall be derated in accordance with Fig.8 Fig.8 	$P_{120^{\circ}\text{C}}=15\text{W}$ at -65 ~ 120°C (Terminal temperature)
Rated power 0.5mΩ	When the terminal temperature exceeds 100°C, the load shall be derated in accordance with Fig.9 Fig.9 	$P_{100^{\circ}\text{C}}=8\text{W}$ at -65 ~ 100°C (Terminal temperature)
Rated power 1.0mΩ	When the terminal temperature exceeds 100°C, the load shall be derated in accordance with Fig.10 Fig.10 	$P_{100^{\circ}\text{C}}=6\text{W}$ at -65 ~ 100°C (Terminal temperature)
Rated voltage Rated current	Rated voltage and current are determined by the following formula. $E = \sqrt{P \times R}$ $I = \sqrt{P / R}$ E : Rated voltage (V) I : Rated current (A) P : Rated power (W) R : Resistance (Ω)	
Resistance	See P1	
Temperature		-65°C ~ +175°C

■PSR350

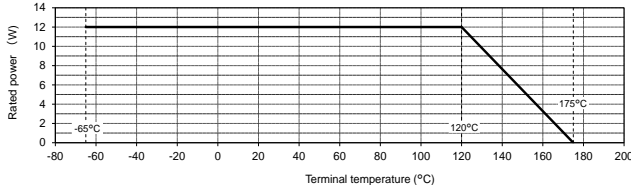
Items	Conditions	Specifications
Rated power 0.27mΩ	When the terminal temperature exceeds 120°C, the load shall be derated in accordance with Fig.11 Fig.11 	P _{120°C} =12W at -65 ~ 120°C (Terminal temperature)
Rated voltage Rated current	Rated voltage and current are determined by the following formula. $E = \sqrt{P \times R}$ $I = \sqrt{P / R}$ E : Rated voltage (V) I : Rated current (A) P : Rated power (W) R : Resistance (Ω)	
Resistance	See <u>P1</u>	
Temperature		-65°C ~ 175°C

■PSR400

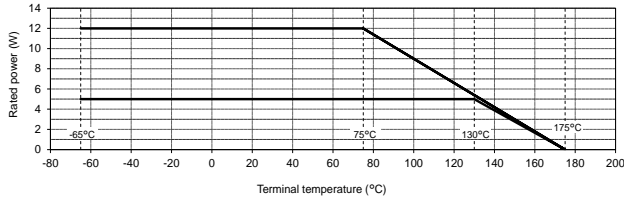
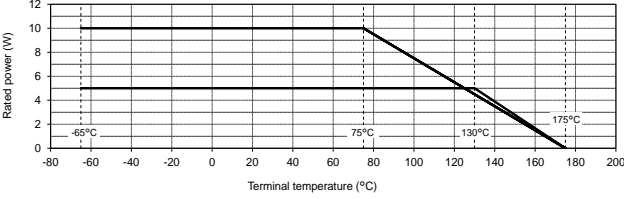
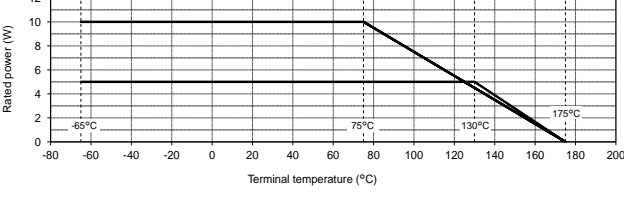
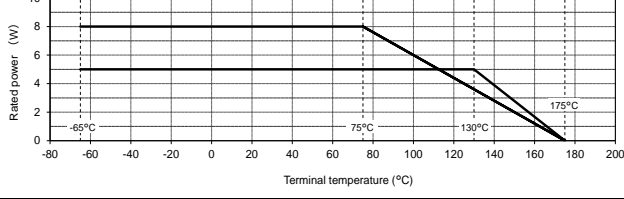
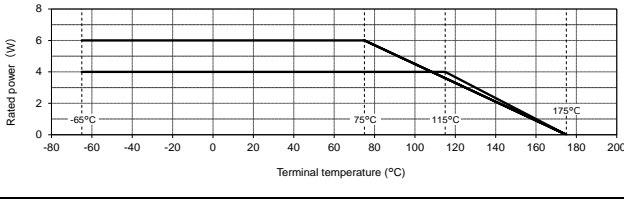
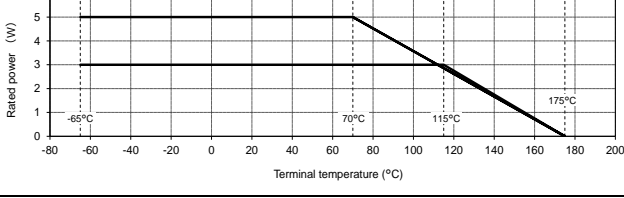
Items	Conditions	Specifications
Rated power 0.2mΩ	When the terminal temperature exceeds 75°C and 130°C, the load shall be derated in accordance with Fig.12 Fig.12 	P _{75°C} =12W at -65 ~ 75°C (Terminal temperature) P _{130°C} =5W at -65 ~ 130°C (Terminal temperature)
Rated power 0.3mΩ	When the terminal temperature exceeds 75°C and 130°C, the load shall be derated in accordance with Fig.13 Fig.13 	P _{75°C} =10W at -65 ~ 75°C (Terminal temperature) P _{130°C} =5W at -65 ~ 130°C (Terminal temperature)
Rated power 0.5mΩ	When the terminal temperature exceeds 75°C and 130°C, the load shall be derated in accordance with Fig.14 Fig.14 	P _{75°C} =10W at -65 ~ 75°C (Terminal temperature) P _{130°C} =5W at -65 ~ 130°C (Terminal temperature)
Rated power 1.0mΩ	When the terminal temperature exceeds 75°C and 130°C, the load shall be derated in accordance with Fig.15 Fig.15 	P _{75°C} =8W at -65 ~ 75°C (Terminal temperature) P _{130°C} =5W at -65 ~ 130°C (Terminal temperature)
Rated power 2.0mΩ	When the terminal temperature exceeds 75°C and 115°C, the load shall be derated in accordance with Fig.16 Fig.16 	P _{75°C} =6W at -65 ~ 75°C (Terminal temperature) P _{115°C} =4W at -65 ~ 115°C (Terminal temperature)
Rated power 3.0mΩ	When the terminal temperature exceeds 70°C and 115°C, the load shall be derated in accordance with Fig.17 Fig.17 	P _{70°C} =5W at -65 ~ 70°C (Terminal temperature) P _{115°C} =3W at -65 ~ 115°C (Terminal temperature)
Rated voltage Rated current	Rated voltage and current are determined by the following formula. $E = \sqrt{P \times R}$ $I = \sqrt{P / R}$ E : Rated voltage (V) I : Rated current (A) P : Rated power (W) R : Resistance (Ω)	
Resistance	See P1	
Temperature		-65°C ~ +175°C

■PSR500

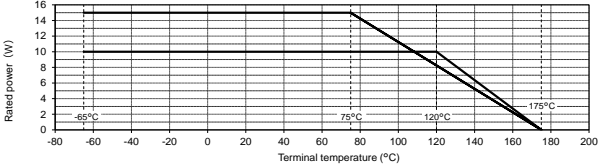
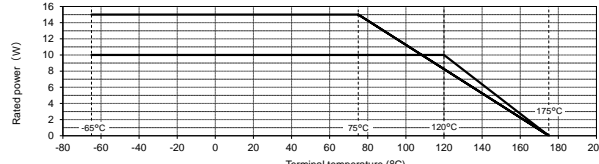
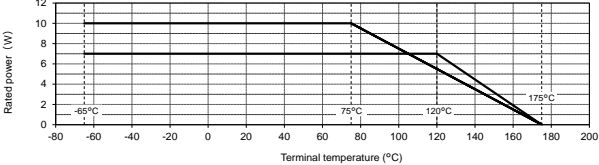
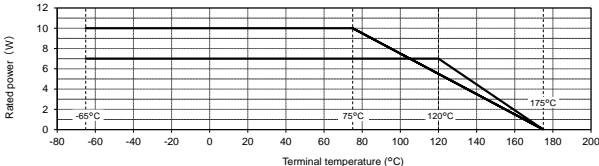
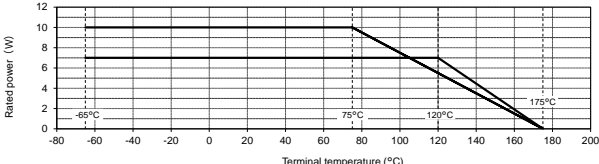
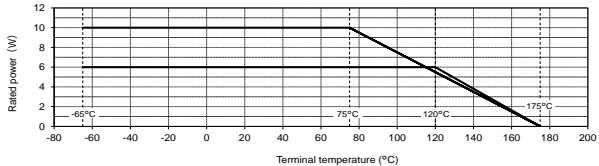
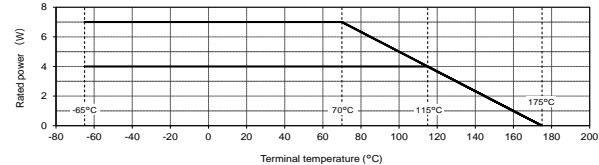
Items	Conditions	Specifications
Rated power 0.1mΩ	When the terminal temperature exceeds 75°C and 120°C, the load shall be derated in accordance with Fig.18 Fig.18 	P _{75°C} =15W at -65 ~ 75°C (Terminal temperature) P _{120°C} =10W at -65 ~ 120°C (Terminal temperature)
Rated power 0.2mΩ	When the terminal temperature exceeds 75°C and 120°C, the load shall be derated in accordance with Fig.19 Fig.19 	P _{75°C} =15W at -65 ~ 75°C (Terminal temperature) P _{120°C} =10W at -65 ~ 120°C (Terminal temperature)
Rated power 0.3mΩ	When the terminal temperature exceeds 75°C and 120°C, the load shall be derated in accordance with Fig.20 Fig.20 	P _{75°C} =10W at -65 ~ 75°C (Terminal temperature) P _{120°C} =7W at -65 ~ 120°C (Terminal temperature)
Rated power 0.4mΩ	When the terminal temperature exceeds 75°C and 120°C, the load shall be derated in accordance with Fig.21 Fig.21 	P _{75°C} =10W at -65 ~ 75°C (Terminal temperature) P _{120°C} =7W at -65 ~ 120°C (Terminal temperature)
Rated power 0.5mΩ	When the terminal temperature exceeds 75°C and 120°C, the load shall be derated in accordance with Fig.22 Fig.22 	P _{75°C} =10W at -65 ~ 75°C (Terminal temperature) P _{120°C} =7W at -65 ~ 120°C (Terminal temperature)
Rated power 1.0mΩ	When the terminal temperature exceeds 75°C and 120°C, the load shall be derated in accordance with Fig.23 Fig.23 	P _{75°C} =10W at -65 ~ 75°C (Terminal temperature) P _{120°C} =6W at -65 ~ 120°C (Terminal temperature)
Rated power 2.0mΩ	When the terminal temperature exceeds 70°C and 115°C, the load shall be derated in accordance with Fig.24 Fig.24 	P _{70°C} =7W at -65 ~ 70°C (Terminal temperature) P _{115°C} =4W at -65 ~ 115°C (Terminal temperature)
Rated voltage Rated current	Rated voltage and current are determined by the following formula. $E = \sqrt{P \times R}$ $I = \sqrt{P / R}$ E : Rated voltage (V) I : Rated current (A) P : Rated power (W) R : Resistance (Ω)	
Resistance	See P ₁	
Temperature		-65 ~ +175°C

●Characteristics

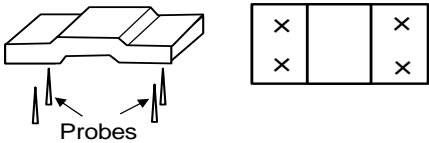
Items	Guaranteed value	Specifications
Resistance	F (±1%)	Measuring method : 4probe per Bottom terminal 
Variation of resistance with temperature	See P1	Test condition : +20/+175°C
Overload	±0.5%	Test condition : See table 1
Solderability	A new uniform coating of minimum of 95% of the surface being immersed.	Flux : Rosin- Ethanol solution(25%weight) with diethylamine hydrochloride(3%weight) Soldering condition : 245±5°C Duration of immersion : 2.0±0.5s
Resistance to soldering heat	±1.0% No remarkable abnormality on the appearance.	Soldering condition : 260±5°C Duration of immersion : 10±1s
Rapid change of temperature	±1.0%	Test temp : -55°C~+155°C 1,000cycles
Temperature humidity storage	±0.5%	85 °C, 85%(Relative humidity) Test time : 1,000h
Endurance (Terminal temperature)	±1.0%	Test condition : See table 2
Endurance (Ambient temperature)	±1.0%	175°C Test time : 1,000h
Component solvent resistance	±0.5%	23±5°C, Immersion cleaning, 5±0.5min Solvent: 2-Propanol
Bend strength of the end face plating	Without open	Endurance with 90mm width Deflection : 3mm

Compliance Standards: IEC60115-1 / IEC60115-8
JIS C 5201-1 / JIS C 5201-8

Table 1 : Test condition of over load

Part No.	Resistance value (mΩ)	Test condition
PSR100	0.2	Rated power×5 Test time : 5s
	0.3	Rated power P _{75°C} ×5 Test time : 5s
	0.5	
	1	
	2	
	3	
PSR330	0.1	Rated power×5 Test time : 5s
	0.5	
	1	
PSR350	0.27	Rated power×5 Test time : 5s
PSR400	0.2	Rated power P _{75°C} ×5 Test time : 5s
	0.3	
	0.5	
	1	
	2	
	3	Rated power P _{70°C} ×5 Test time : 5s
PSR500	0.1	Rated power P _{75°C} ×5 Test time : 5s
	0.2	
	0.3	
	0.4	
	0.5	
	1	
	2	Rated power P _{70°C} ×5 Test time : 5s

Table 2 : Test condition of endurance (terminal temperature)

Part No.	Resistance value (mΩ)	Test condition	
PSR100	0.2	T _k = 120°C, Rated power 1.5h:ON-0.5h:OFF Test time : 1,000h	
	0.3	T _k = 75°C, Rated power P _{75°C} 1.5h:ON-0.5h:OFF Test time : 1,000h	T _k = 140°C, Rated power P _{140°C} 1.5h:ON-0.5h:OFF Test time : 1,000h
	0.5		
	1		
	2		
	3		
PSR330	0.1	T _k = 120°C, Rated power 1.5h:ON-0.5h:OFF Test time : 1,000h	
	0.5	T _k = 100°C, Rated power 1.5h:ON-0.5h:OFF Test time : 1,000h	
	1		
PSR350	0.27	T _k = 120°C, Rated power 1.5h:ON-0.5h:OFF Test time : 1,000h	
PSR400	0.2	T _k = 75°C, Rated power P _{75°C} 1.5h:ON-0.5h:OFF Test time : 1,000h	T _k = 130°C, Rated power P _{130°C} 1.5h:ON-0.5h:OFF Test time : 1,000h
	0.3		
	0.5		
	1	T _k = 70°C, Rated power P _{70°C} 1.5h:ON-0.5h:OFF Test time : 1,000h	T _k = 115°C, Rated power P _{115°C} 1.5h:ON-0.5h:OFF Test time : 1,000h
	2		
	3		
PSR500	0.1	T _k = 75°C, Rated power P _{75°C} 1.5h:ON-0.5h:OFF Test time : 1,000h	T _k = 120°C, Rated power P _{120°C} 1.5h:ON-0.5h:OFF Test time : 1,000h
	0.2		
	0.3		
	0.4		
	0.5		
	1	T _k = 70°C, Rated power P _{70°C} 1.5h:ON-0.5h:OFF Test time : 1,000h	T _k = 115°C, Rated power P _{115°C} 1.5h:ON-0.5h:OFF Test time : 1,000h
	2		

●Tape dimensions
 ■Embossed tape

PSR100 / 330 / 350 / 400

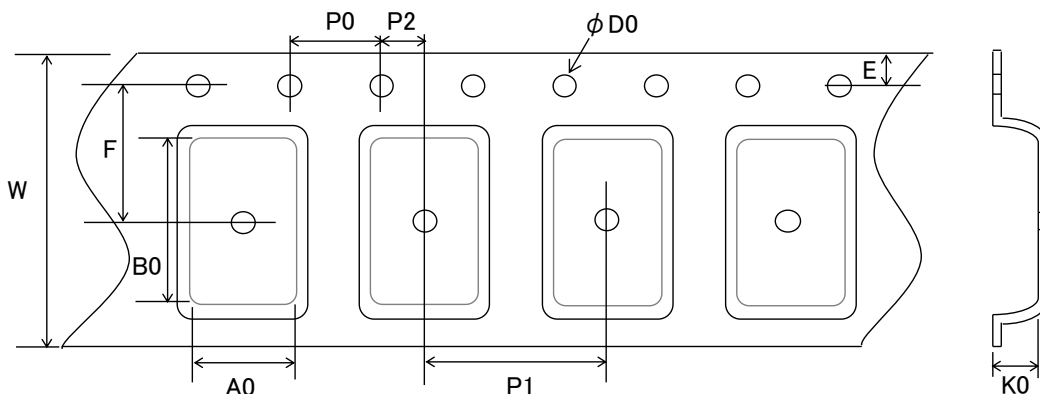

PSR500

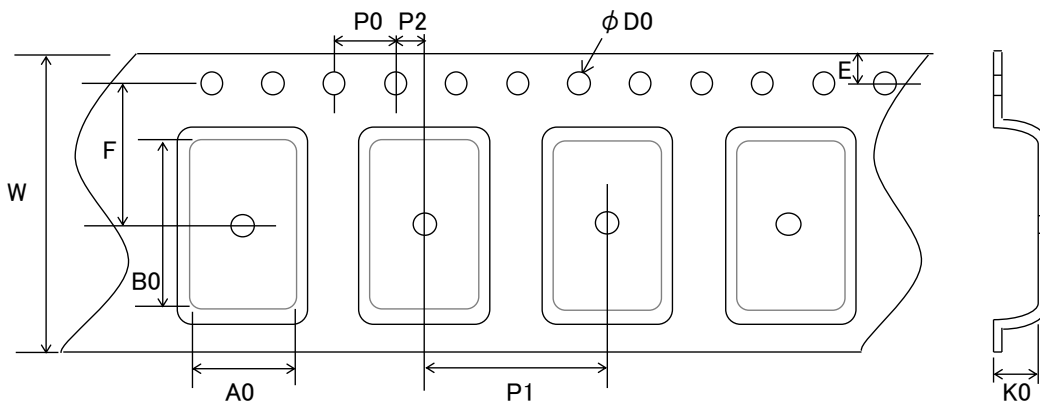

(Unit : mm)

品名	W	F	E	A0	B0	D0	P0	P1	P2	K
PSR100	12.0±0.2	5.5±0.05	1.75±0.1	3.5±0.1	6.6±0.1	Φ1.5+0.1 0	4.0±0.1	8.0±0.1	2.0±0.05	1.6±0.1
PSR330	12.0±0.2	5.5±0.05	1.75±0.1	6.7±0.1	6.6±0.1	Φ1.5+0.1 0	4.0±0.1	8.0±0.1	2.0±0.05	2.3±0.1*4
PSR350	16.0±0.2	7.5±0.1	1.75±0.1	6.1±0.1	8.2±0.1	Φ1.5+0.1 0	4.0±0.1	8.0±0.1	2.0±0.1	1.5±0.15
PSR400	16.0±0.2	7.5±0.1	1.75±0.1	5.7±0.2	10.5±0.2	Φ1.5+0.1 0	4.0±0.1	8.0±0.1	2.0±0.1	2.3±0.1
PSR500	24.0±0.2	11.5±0.1	1.75±0.1	8.3±0.2	15.6±0.2	Φ1.5+0.1 0	4.0±0.1	12.0±0.1	2.0±0.1	2.3±0.1

*4 : Only 0.2mΩ

●Reel dimension

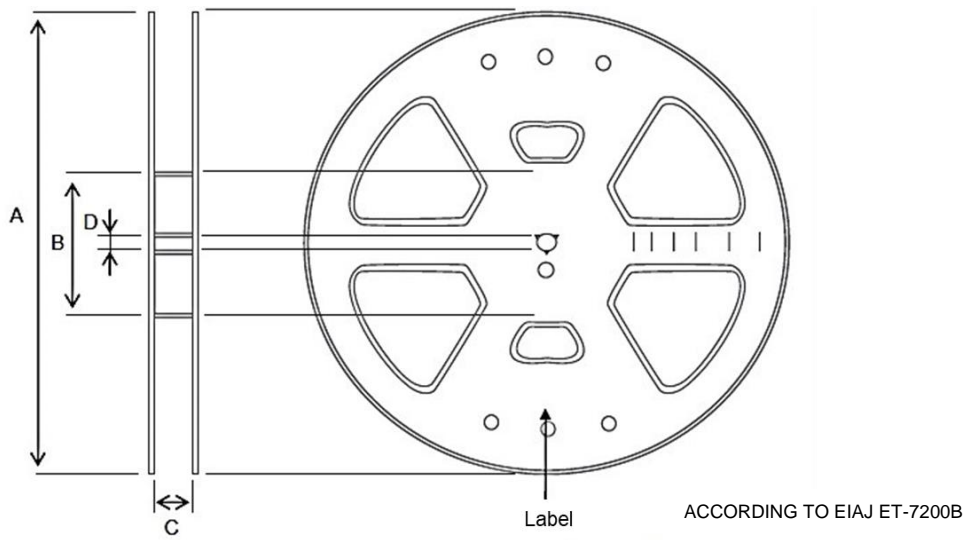

(Unit : mm)

Part No.	A	B	C	D
PSR100	Φ330±2.0	Φ100±1.0	13.4±1.0	Φ13.0±0.2
PSR330				
PSR350			17.4±1.0	
PSR400				
PSR500				

Notice

Precaution on using ROHM Products

1. If you intend to use our Products in devices requiring extremely high reliability (such as medical equipment ^(Note 1), aircraft/spacecraft, nuclear power controllers, etc.) and whose malfunction or failure may cause loss of human life, bodily injury or serious damage to property ("Specific Applications"), please consult with the ROHM sales representative in advance. Unless otherwise agreed in writing by ROHM in advance, ROHM shall not be in any way responsible or liable for any damages, expenses or losses incurred by you or third parties arising from the use of any ROHM's Products for Specific Applications.

(Note1) Medical Equipment Classification of the Specific Applications

JAPAN	USA	EU	CHINA
CLASS III	CLASS III	CLASS II b	CLASS III
CLASS IV		CLASS III	

2. ROHM designs and manufactures its Products subject to strict quality control system. However, semiconductor products can fail or malfunction at a certain rate. Please be sure to implement, at your own responsibilities, adequate safety measures including but not limited to fail-safe design against the physical injury, damage to any property, which a failure or malfunction of our Products may cause. The following are examples of safety measures:
 - [a] Installation of protection circuits or other protective devices to improve system safety
 - [b] Installation of redundant circuits to reduce the impact of single or multiple circuit failure
3. Our Products are not designed under any special or extraordinary environments or conditions, as exemplified below. Accordingly, ROHM shall not be in any way responsible or liable for any damages, expenses or losses arising from the use of any ROHM's Products under any special or extraordinary environments or conditions. If you intend to use our Products under any special or extraordinary environments or conditions (as exemplified below), your independent verification and confirmation of product performance, reliability, etc. prior to use, must be necessary:
 - [a] Use of our Products in any types of liquid, including water, oils, chemicals, and organic solvents
 - [b] Use of our Products outdoors or in places where the Products are exposed to direct sunlight or dust
 - [c] Use of our Products in places where the Products are exposed to sea wind or corrosive gases, including Cl₂, H₂S, NH₃, SO₂, and NO₂
 - [d] Use of our Products in places where the Products are exposed to static electricity or electromagnetic waves
 - [e] Use of our Products in proximity to heat-producing components, plastic cords, or other flammable items
 - [f] Sealing or coating our Products with resin or other coating materials
 - [g] Use of our Products without cleaning residue of flux (Exclude cases where no-clean type fluxes is used. However, recommend sufficiently about the residue.); or Washing our Products by using water or water-soluble cleaning agents for cleaning residue after soldering
 - [h] Use of the Products in places subject to dew condensation
4. The Products are not subject to radiation-proof design.
5. Please verify and confirm characteristics of the final or mounted products in using the Products.
6. In particular, if a transient load (a large amount of load applied in a short period of time, such as pulse, is applied, confirmation of performance characteristics after on-board mounting is strongly recommended. Avoid applying power exceeding normal rated power; exceeding the power rating under steady-state loading condition may negatively affect product performance and reliability.
7. De-rate Power Dissipation depending on ambient temperature. When used in sealed area, confirm that it is the use in the range that does not exceed the maximum junction temperature.
8. Confirm that operation temperature is within the specified range described in the product specification.
9. ROHM shall not be in any way responsible or liable for failure induced under deviant condition from what is defined in this document.

Precaution for Mounting / Circuit board design

1. When a highly active halogenous (chlorine, bromine, etc.) flux is used, the residue of flux may negatively affect product performance and reliability.
2. In principle, the reflow soldering method must be used on a surface-mount products, the flow soldering method must be used on a through hole mount products. If the flow soldering method is preferred on a surface-mount products, please consult with the ROHM representative in advance.

For details, please refer to ROHM Mounting specification

Precautions Regarding Application Examples and External Circuits

1. If change is made to the constant of an external circuit, please allow a sufficient margin considering variations of the characteristics of the Products and external components, including transient characteristics, as well as static characteristics.
2. You agree that application notes, reference designs, and associated data and information contained in this document are presented only as guidance for Products use. Therefore, in case you use such information, you are solely responsible for it and you must exercise your own independent verification and judgment in the use of such information contained in this document. ROHM shall not be in any way responsible or liable for any damages, expenses or losses incurred by you or third parties arising from the use of such information.

Precaution for Electrostatic

This Product is electrostatic sensitive product, which may be damaged due to electrostatic discharge. Please take proper caution in your manufacturing process and storage so that voltage exceeding the Products maximum rating will not be applied to Products. Please take special care under dry condition (e.g. Grounding of human body / equipment / solder iron, isolation from charged objects, setting of Ionizer, friction prevention and temperature / humidity control).

Precaution for Storage / Transportation

1. Product performance and soldered connections may deteriorate if the Products are stored in the places where:
 - [a] the Products are exposed to sea winds or corrosive gases, including Cl₂, H₂S, NH₃, SO₂, and NO₂
 - [b] the temperature or humidity exceeds those recommended by ROHM
 - [c] the Products are exposed to direct sunshine or condensation
 - [d] the Products are exposed to high Electrostatic
2. Even under ROHM recommended storage condition, solderability of products out of recommended storage time period may be degraded. It is strongly recommended to confirm solderability before using Products of which storage time is exceeding the recommended storage time period.
3. Store / transport cartons in the correct direction, which is indicated on a carton with a symbol. Otherwise bent leads may occur due to excessive stress applied when dropping of a carton.
4. Use Products within the specified time after opening a humidity barrier bag. Baking is required before using Products of which storage time is exceeding the recommended storage time period.

Precaution for Product Label

A two-dimensional barcode printed on ROHM Products label is for ROHM's internal use only.

Precaution for Disposition

When disposing Products please dispose them properly using an authorized industry waste company.

Precaution for Foreign Exchange and Foreign Trade act

Since concerned goods might be fallen under listed items of export control prescribed by Foreign exchange and Foreign trade act, please consult with ROHM in case of export.

Precaution Regarding Intellectual Property Rights

1. All information and data including but not limited to application example contained in this document is for reference only. ROHM does not warrant that foregoing information or data will not infringe any intellectual property rights or any other rights of any third party regarding such information or data.
2. ROHM shall not have any obligations where the claims, actions or demands arising from the combination of the Products with other articles such as components, circuits, systems or external equipment (including software).
3. No license, expressly or implied, is granted hereby under any intellectual property rights or other rights of ROHM or any third parties with respect to the Products or the information contained in this document. Provided, however, that ROHM will not assert its intellectual property rights or other rights against you or your customers to the extent necessary to manufacture or sell products containing the Products, subject to the terms and conditions herein.

Other Precaution



1. This document may not be reprinted or reproduced, in whole or in part, without prior written consent of ROHM.
2. The Products may not be disassembled, converted, modified, reproduced or otherwise changed without prior written consent of ROHM.
3. In no event shall you use in any way whatsoever the Products and the related technical information contained in the Products or this document for any military purposes, including but not limited to, the development of mass-destruction weapons.
4. The proper names of companies or products described in this document are trademarks or registered trademarks of ROHM, its affiliated companies or third parties.

General Precaution

1. Before you use our Products, you are requested to carefully read this document and fully understand its contents. ROHM shall not be in any way responsible or liable for failure, malfunction or accident arising from the use of any ROHM's Products against warning, caution or note contained in this document.
2. All information contained in this document is current as of the issuing date and subject to change without any prior notice. Before purchasing or using ROHM's Products, please confirm the latest information with a ROHM sales representative.
3. The information contained in this document is provided on an "as is" basis and ROHM does not warrant that all information contained in this document is accurate and/or error-free. ROHM shall not be in any way responsible or liable for any damages, expenses or losses incurred by you or third parties resulting from inaccuracy or errors of or concerning such information.

Looking for pricing, stock, or lifecycle information?

Click below to explore more details on WIN SOURCE:

-  [View PSR400ITQFJ2L00 on WIN SOURCE](#)
-  [Rohm Semiconductor](#) Information

Optimize Your Supply Chain with WIN SOURCE Solutions

-  Global Sourcing Solution
-  Obsolete Management
-  Cost Control Management
-  Shortage Management
-  Alternative Solution
-  Excess Inventory Management