



**THE DATASHEET OF  
EMK325BJ226MM-TR**



### Asymmetrical Discrete Series - DO-214



#### Agency Approvals

Agency	Agency File Number
	E133083

#### Pinout Designation

Not Applicable

#### Schematic Symbol



#### Description

The Asymmetrical Discrete Series are SIDACtor® components designed to protect LCAS (Line Circuit Access Switch) devices from damaging overvoltage transients.

The series provides a specialized asymmetrical overvoltage protection solution that enables equipment to comply with various global regulatory standards.

#### Features and Benefits

- Low voltage overshoot ratings
- Low on-state voltage
- Does not degrade surge capability after multiple surge events within limit.
- Fails short circuit when surged in excess of ratings
- LCAS specific tip and ring thresholds
- RoHS Compliant, Lead-Free, and Halogen-Free
- 2nd level interconnect is Pb-free per IPC/JEDEC J-STD-609A.01

#### Applicable Global Standards

- TIA-968-A
- TIA-968-B
- ITU K.20/21 Enhanced Level\*
- ITU K.20/21 Basic Level
- GR 1089 Inter-building\*
- GR 1089 Intra-building
- IEC 61000-4-5 2nd edition
- YD/T 1082
- YD/T 993
- YD/T 950

\*A/B-rated parts require series resistance

#### Additional Information



Datasheet



Resources



Samples

#### Electrical Characteristics

Part Number	Marking	$V_{DRM}$ @ $I_{DRM}=5\mu A$	$V_S$ @ 100V/ $\mu s$	$I_H$	$I_S$	$I_T$	$V_T$ @ $I_T=2.2 A$	Capacitance @ 1MHz, 2V bias	
		V min	V max	mA min	mA max	A max	V max	pF min	pF max
P1200SALRP	P12A	100	130	120	800	2.2	4	15	40
P2000SALRP	P20A	180	220	120	800	2.2	4	15	35
P2500SALRP	P25A	230	290	120	800	2.2	4	15	35
P1200SBLRP	P12B	100	130	120	800	2.2	4	20	50
P2000SBLRP	P20B	180	220	120	800	2.2	4	20	50
P2500SBLRP	P25B	230	290	120	800	2.2	4	20	50
P1200SCLRP	P12C	100	130	120	800	2.2	4	20	35
P2000SCLRP	P20C	180	220	120	800	2.2	4	25	35
P2500SCLRP	P25C	230	290	120	800	2.2	4	30	70

Notes:  
 - Absolute maximum ratings measured at  $T_A = 25^\circ C$  (unless otherwise noted).  
 - Components are bi-directional.

**Surge Ratings**

Series	$I_{PP}$									$I_{TSM}$ 50/60 Hz	di/dt
	0.2/310 <sup>1</sup>	2/10 <sup>1</sup>	8/20 <sup>1</sup>	10/160 <sup>1</sup>	10/560 <sup>1</sup>	5/320 <sup>1</sup>	10/360 <sup>1</sup>	10/1000 <sup>1</sup>	5/310 <sup>1</sup>		
	0.5/700 <sup>2</sup>	2/10 <sup>2</sup>	1.2/50 <sup>2</sup>	10/160 <sup>2</sup>	10/560 <sup>2</sup>	9/720 <sup>2</sup>	10/360 <sup>2</sup>	10/1000 <sup>2</sup>	10/700 <sup>2</sup>		
	A min	A min	A min	A min	A min	A min	A min	A min	A min	A min	Amps/ $\mu$ s max
A	20	150	150	90	50	75	75	45	75	25	500
B	25	250	250	150	100	100	125	80	100	30	500
C	50	500	400	200	150	200	175	100	200	35	500

Notes:

- 1 Current waveform in  $\mu$ s
- 2 Voltage waveform in  $\mu$ s
- Peak pulse current rating ( $I_{PP}$ ) is repetitive and guaranteed for the life of the product.
- $I_{PP}$  ratings applicable over temperature range of -40°C to +85°C
- The component must initially be in thermal equilibrium with -40°C  $\leq T_J \leq$  +150°C

**Thermal Considerations**

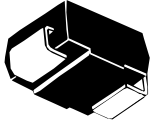
Package	Symbol	Parameter	Value	Unit
DO-214AA 	$T_J$	Operating Junction Temperature Range	-40 to +150	°C
	$T_S$	Storage Temperature Range	-65 to +150	°C
	$R_{\theta JA}$	Thermal Resistance: Junction to Ambient	90	°C/W

**V-I Characteristics**

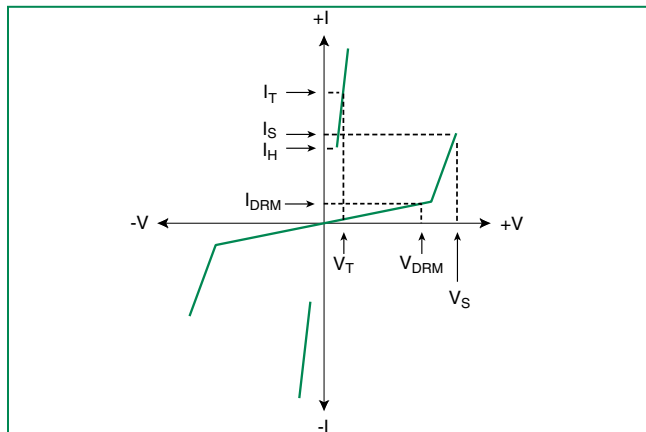

**$t_r \times t_d$  Pulse Waveform**

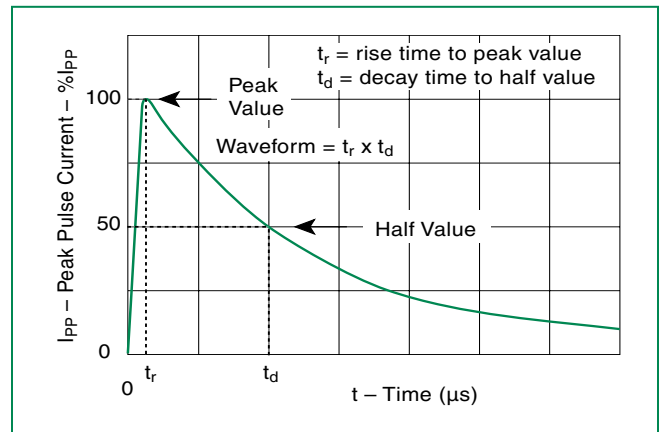

**Normalized  $V_S$  Change vs. Junction Temperature**

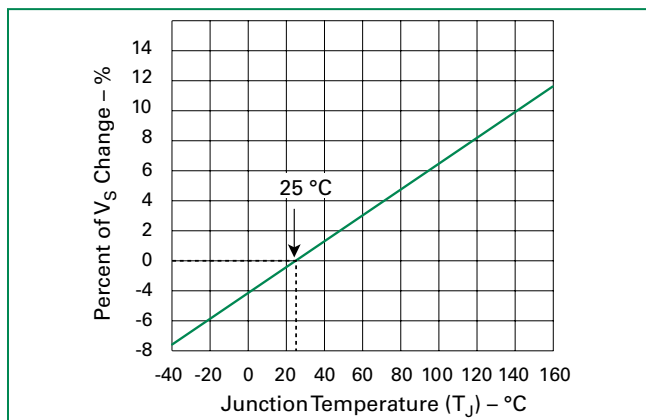

**Normalized DC Holding Current vs. Case Temperature**

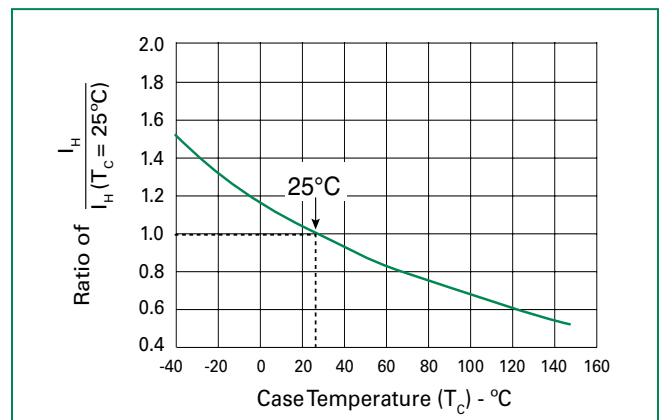

**Soldering Parameters**

Reflow Condition		Pb-Free assembly (see Fig. 1)
Pre Heat	-Temperature Min ( $T_{s(min)}$ )	+150°C
	-Temperature Max ( $T_{s(max)}$ )	+200°C
	-Time (Min to Max) ( $t_s$ )	60-180 secs.
Average ramp up rate (Liquidus Temp ( $T_L$ ) to peak)		3°C/sec. Max.
$T_{s(max)}$ to $T_L$ - Ramp-up Rate		3°C/sec. Max.
Reflow	-Temperature ( $T_L$ ) (Liquidus)	+217°C
	-Temperature ( $t_L$ )	60-150 secs.
Peak Temp ( $T_p$ )		+260(+0/-5)°C
Time within 5°C of actual Peak Temp ( $t_p$ )		30 secs. Max.
Ramp-down Rate		6°C/sec. Max.
Time 25°C to Peak Temp ( $T_p$ )		8 min. Max.
Do not exceed		+260°C

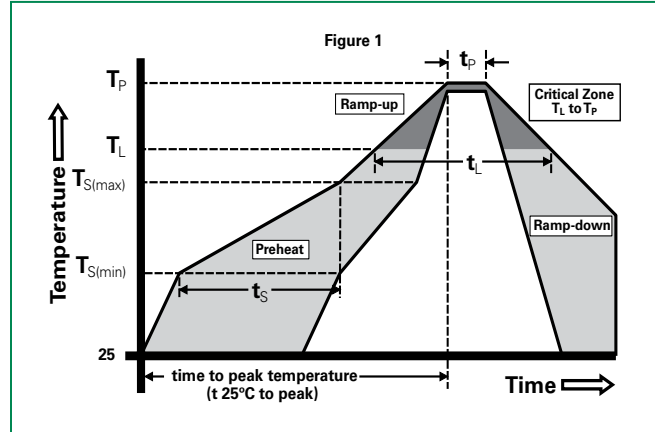

**Physical Specifications**

<b>Lead Material</b>	Copper Alloy
<b>Terminal Finish</b>	100% Matte-Tin Plated
<b>Body Material</b>	UL recognized epoxy meeting flammability classification V-0

**Environmental Specifications**

<b>High Temp Voltage Blocking</b>	80% Rated $V_{DRM}$ ( $V_{AC}$ Peak) +125°C or +150°C, 504 or 1008 hrs. MIL-STD-750 (Method 1040) JEDEC, JESD22-A-101
<b>Temp Cycling</b>	-65°C to +150°C, 15 min. dwell, 10 up to 100 cycles. MIL-STD-750 (Method 1051) EIA/JEDEC, JESD22-A104
<b>Biased Temp &amp; Humidity</b>	52 $V_{DC}$ (+85°C) 85%RH, 504 up to 1008 hrs. EIA/JEDEC, JESD22-A-101
<b>High Temp Storage</b>	+150°C 1008 hrs. MIL-STD-750 (Method 1031) JEDEC, JESD22-A-101
<b>Low Temp Storage</b>	-65°C, 1008 hrs.
<b>Thermal Shock</b>	0°C to +100°C, 5 min. dwell, 10 sec. transfer, 10 cycles. MIL-STD-750 (Method 1056) JEDEC, JESD22-A-106
<b>Autoclave (Pressure Cooker Test)</b>	+121°C, 100%RH, 2atm, 24 up to 168 hrs. EIA/JEDEC, JESD22-A-102
<b>Resistance to Solder Heat</b>	+260°C, 30 secs. MIL-STD-750 (Method 2031)
<b>Moisture Sensitivity Level</b>	85%RH, +85°C, 168 hrs., 3 reflow cycles (+260°C Peak). JEDEC-J-STD-020, Level 1

**Part Numbering**

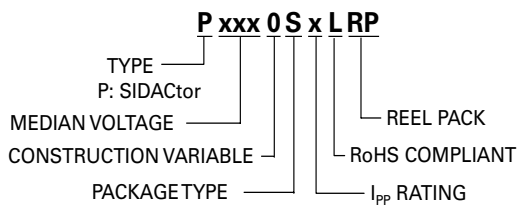

**Part Marking**

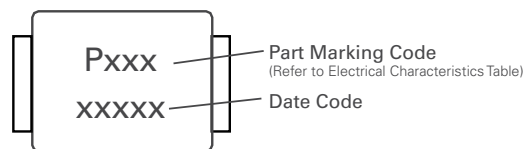

**Dimensions — DO-214AA**

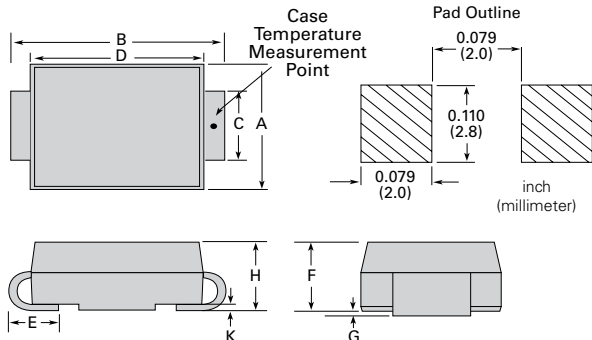

Dimensions	Inches		Millimeters	
	Min	Max	Min	Max
A	0.130	0.156	3.30	3.95
B	0.201	0.220	5.10	5.60
C	0.077	0.087	1.95	2.20
D	0.159	0.181	4.05	4.60
E	0.030	0.063	0.75	1.60
F	0.075	0.096	1.90	2.45
G	0.002	0.008	0.05	0.20
H	0.077	0.104	1.95	2.65
K	0.006	0.016	0.15	0.41

**Packing Options**

Package Type	Description	Quantity	Added Suffix	Industry Standard
S	DO-214AA Tape & Reel Pack	2500	RP	EIA-481-D

**Tape and Reel Specification — DO-214AA**

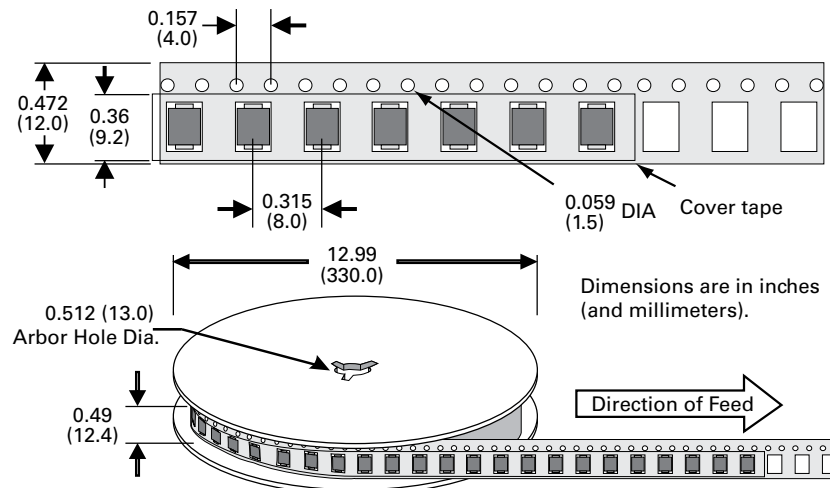

## Looking for pricing, stock, or lifecycle information?

Click below to explore more details on WIN SOURCE:

⊖ [View EMK325BJ226MM-TR on WIN SOURCE](#)

⊖ [Taiyo Yuden Information](#)

## Optimize Your Supply Chain with WIN SOURCE Solutions

- ✓ Global Sourcing Solution
- ✓ Obsolete Management
- ✓ Cost Control Management
- ✓ Shortage Management
- ✓ Alternative Solution
- ✓ Excess Inventory Management