



THE DATASHEET OF H7008NL



NOTES:

1. ROHS COMPLIANT
2. HEADER: THERMOSET PLASTIC MATERIAL WITH FLAMMABILITY RATING UL 94V-0 OR BETTER.
3. STORAGE TEMPERATURE: -20°C TO +125°C
4. COMPLIANCE TO J-STD:
 - A. J-STD-002: SOLDERABILITY AT 245°C REFLOW PROFILE
 - B. J-STD-020: LEVEL 1, NO MOISTURE SENSITIVE
 - C. J-STD-075: R7, 245°C MAXIMUM THROUGH REFLOW SOLDER
5. TO ORDER TAPE & REEL PACKAGING ADD A "T" SUFFIX TO THE PART NUMBER(i.e H7008NL BECOMES H7008NLT).

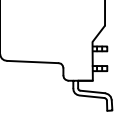
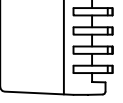

FINA

© Copyright, 2015. Pulse Electronics Corp. All rights reserved. Pulse confidential & proprietary. (07/30/15)

PRODUCT DESCRIPTION	TLA DRAWING	PS DRAWING	SHEET
MDL,SIN,10G,1:1,SM,OH	H7008NL-14	PS-2517.001-A	1 OF 3

E-MAIL: PRODINFONETWORK@PULSEELECTRONICS.COM(US). ASIA@PULSEELECTRONICS.COM(Asia)

PHONE: USA:858 674 8100, GERMANY:49 7032 78060, SINGAPORE:65

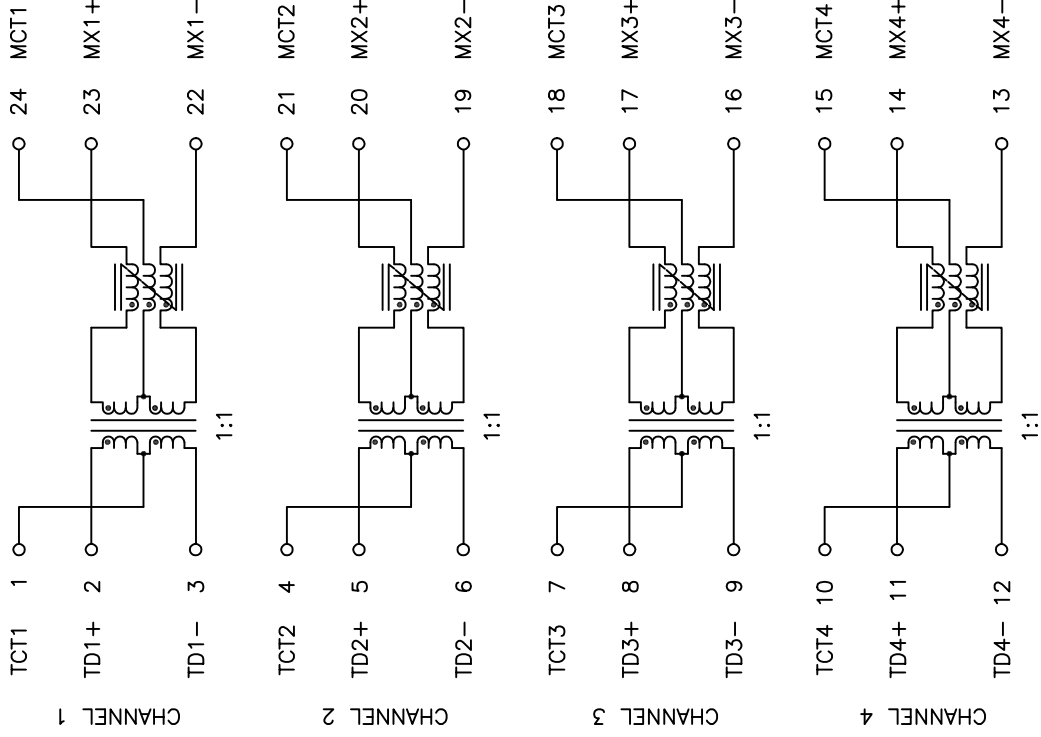

SCHEMATIC

ELECTRICAL CHARACTERISTICS AT -
MEETS IEEE 802.3

PARAMETER	
OPERATING TEMP	
TURNS RATIO	
POLARITY	
INSERTION LOSS	100 KHz -3.0 dB MAX
RETURN LOSS (Z OUT = 100 OHM ± 1%)	1-40 MHz -18 dB MIN
INDUCTANCE (OCL)	200 uH 1-100 MHz -40 dB
CROSSTALK, ADJACENT CHANNELS	1-100 MHz -35 dB MIN
COMMON MODE REJECTION RATIO	1-250 MHz -30 dB
INPUT - OUTPUT ISOLATION	1500

NOTE: f IS FREQUENCY IN MHZ.

© Copyright, 2015. Pulse Electronics Corp. All rights reserved. Pulse confidential & proprietary. (07/30/15)

PRODUCT DESCRIPTION	TLA DRAWING	PS DRAWING	SHEET
MDL,SIN,10G,1:1,SM,OH	H7008NL-14	PS-2517.001-A	2 OF 3

E-MAIL: PRODINFONETWORK@PULSEELECTRONICS.COM(US). ASIA@PULSEELECTRONICS.COM(Asia) PHONE: USA:858 674 8100, GERMANY:49 7032 78060, SINGAPORE:65

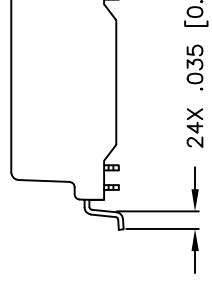
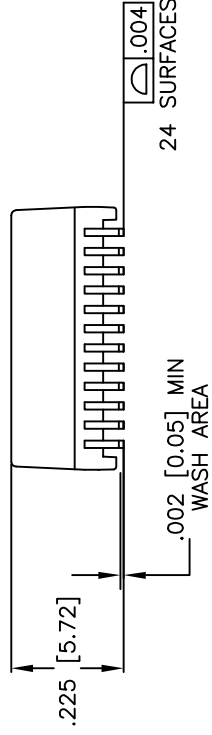
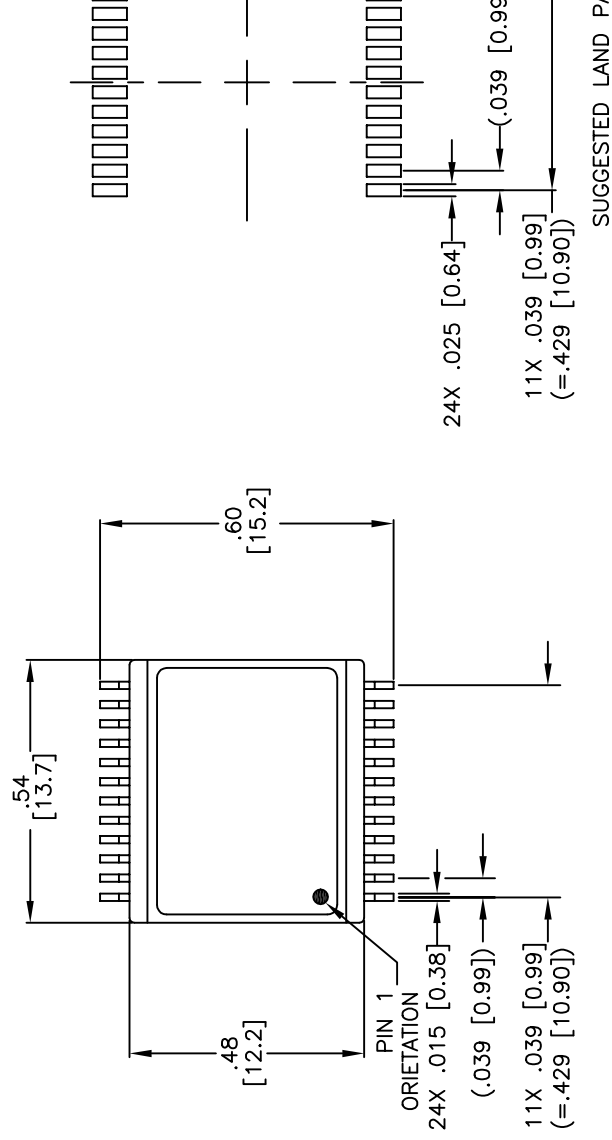

DIMENSIONS ARE IN INCHES [MILLIMETERS] WITH THE FOLLOWING TOLERANCES: [MILLIMETERS] ARE FOR REFERENCE ONLY.
 .XX = ±0.02 [±0.50]
 .XXX = ±0.010 [±0.25]

© Copyright, 2015. Pulse Electronics Corp. All rights reserved. Pulse confidential & proprietary. (07/30/15)



PRODUCT DESCRIPTION	TLA DRAWING	PS DRAWING	SHEET
MDL,SIN,10G,1:1,SM,OH	H7008NL-14	PS-2517.001-A	3 OF 3

E-MAIL: PRODINFONETWORK@PULSEELECTRONICS.COM(US). ASIA@PULSEELECTRONICS.COM(Asia)

PHONE: USA:858 674 8100, GERMANY:49 7032 78060, SINGAPORE:65

Looking for pricing, stock, or lifecycle information?

Click below to explore more details on WIN SOURCE:

-  [View H7008NL on WIN SOURCE](#)
-  [Pulse Information](#)

Optimize Your Supply Chain with WIN SOURCE Solutions

-  Global Sourcing Solution
-  Obsolete Management
-  Cost Control Management
-  Shortage Management
-  Alternative Solution
-  Excess Inventory Management