



THE DATASHEET OF HMU2103NL



-125°C

AT 245°C REFLOW PROFILE

MOISTURE SENSITIVE

KIMMUM THROUGH REFLOW SOLDER

ADD A "T" SUFFIX

L BECOMES HXXXXXXXXNLT).

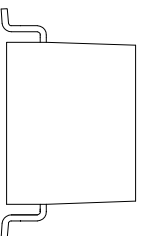
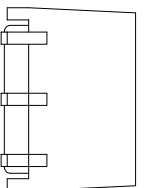
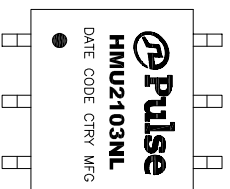

FINAL OUTLINE

rights reserved. Pulse confidential & proprietary. (09/01/17)

QTY	DESCRIPTION	REV	DATE	BY	APP
1	PS DRAWING				
1	PS-2303.002-A				
1	SHEET				
1	OF 5				
	PART NO.				
	HMU2103NL				
	DATASHEET REV.				
	E				

ELECTRICAL CHARACTERISTICS AT +25°C UNLESS OTHER SPECIFIED
(FOR REFERENCE ONLY. USED FOR CUSTOMER INFORMATION.)

PARAMETER	SPECIFICATIONS	
QUALIFICATION	PER AEC-Q200	
OPERATING TEMPERATURE	-40°C TO +125°C	
TURNS RATIO	1.00 ± 2%	
POLARITY	PER SCHEMATIC	
DC RESISTANCE	TRANSFORMER SIDE	CM CHOKE SIDE
	0.35 OHMS MAX	0.80 OHMS MAX
▽ INDUCTANCE (OCL) AT 100 KHZ, 100 mV (-40°C TO +125°C)	150 uH MIN, 370 uH MAX	
▽ INSERTION LOSS	0.30 dB MAX @ 4 MHZ	
RETURN LOSS (Z OUT = 100 OHM ±15%)	20 dB MIN @ 4 MHZ	
COMMON MODE REJECTION RATIO	1 - 10 MHZ	10-1000 MHZ
	-35 dB MIN	-20 dB MIN
▽ INPUT - OUTPUT ISOLATION	4300 VDC FOR 60 SECONDS	
WORKING VOLTAGE	1000 VDC FOR 15 YEARS	
CREEPAGE DISTANCE	> 5mm	

NOTE: "▽" IS SPECIAL CHARACTERISTIC.

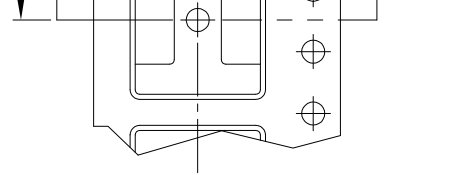

C	D ₀	E	F	P ₀
1.5	1.75	7.5	4.0	

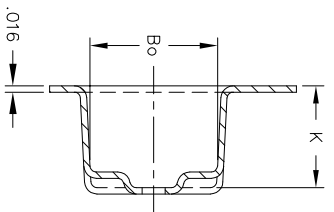

SECTION A—A

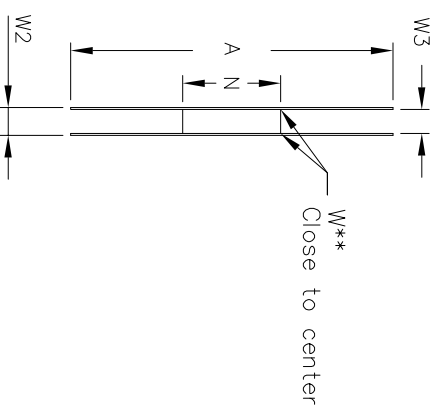
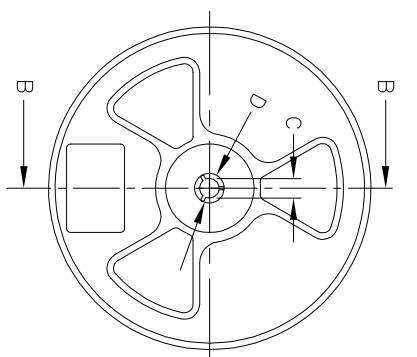

Tolerance	A	B	C	D	N	W1	W2	W3	W3	
Tape width	330.00	min. 1.50	±0.8	min. 13.00	min. 20.20	min. 100.00	+2.0	max. 16.4	min. 16.4	max. 18.39

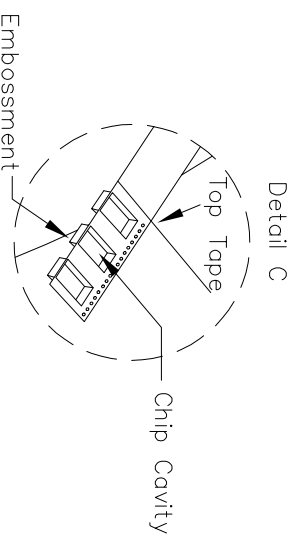
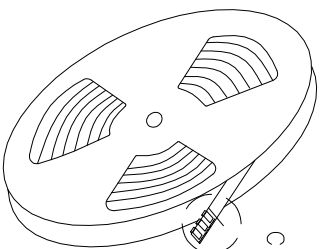
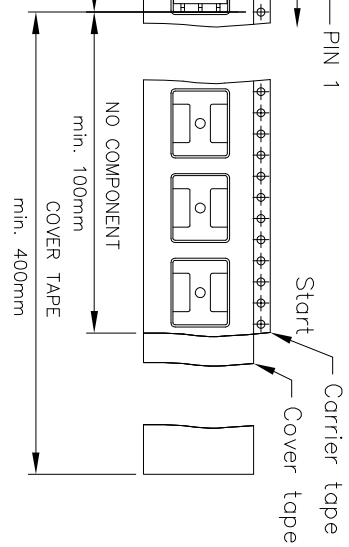

rights reserved. Pulse confidential & proprietary. (09/01/17)

A DRAWING	PS DRAWING	SHEET	PART NO.	DATASHEET REV.
J2103NL-12	PS-2303.002-A	4 OF 5	HMU2103NL	E

ELECTRONICS.COM(Asio) PHONE:USA:858 674 8100, GERMANY:49 7032 78060, SINGAPORE:65 6287 8998, SHANGHAI:86 21 62787060, TAIWAN:886 3 4356768

DESCRIPTION



170 UH MIN, 350 UH MAX TO 150 UH MIN, 370 UH MAX
ON FROM AEC-Q200 (PENDING) TO PER AEC-Q200
, AND "AEC-Q200" LOGO
AND PACKING INFORMATION

rights reserved. Pulse confidential & proprietary. (09/01/17)

DRAWING	PS DRAWING	SHEET	PART NO.	DATASHEET REV.
J2103NL-12	PS-2303.002-A	5 OF 5	HMU2103NL	E

Looking for pricing, stock, or lifecycle information?

Click below to explore more details on WIN SOURCE:

-  [View HMU2103NL on WIN SOURCE](#)
-  [Pulse Information](#)

Optimize Your Supply Chain with WIN SOURCE Solutions

-  Global Sourcing Solution
-  Obsolete Management
-  Cost Control Management
-  Shortage Management
-  Alternative Solution
-  Excess Inventory Management