





**THE DATASHEET OF
G93270002**



PSE Technology Corporation

SPECIFICATION FOR APPROVAL

CUSTOMER	_____
NOMINAL FREQUENCY	32.768 KHz
PRODUCT TYPE	TYPE G9 SMD CRYSTAL
SPEC. NO. (P/N)	G93270002
CUSTOMER P/N	_____
ISSUE DATE	Oct.31,2013
VERSION	C

APPROVED	PREPARED	QA
		
APPROVED BY CUSTOMER :		AVL Status
Please return one copy with approval to PSE-TW		

PSE Technology Corporation

No.2, Tzu-Chiang 5th Rd, Chung Li Industrial Park,
 Chung Li City, Taoyuan County, Taiwan (R.O.C.)
 TEL: 886-3-451-8888
 FAX: 886-3-461-3865
<http://www.saronix-ecera.com.tw>

- *Pb-free
- *RoHS Compliant
- *HF-Halogen Free
- *REACH Compliant

*** A company of  **PERICOM Semiconductor Corporation** ***

TYPE G9 SMD CRYSTAL

G93270002

VER. C 31-Oct-13

ELECTRICAL SPECIFICATIONS

SRe Part Number : G93270002

Parameters	Symbol	Specifications	Units	Notes
Nominal Frequency	Fn	32.768	KHz	
Frequency Tolerance	FT	± 20	ppm	at 25 °C ± 5 °C
Load Capacitance	CL	12.5	pF	Typ.
Drive Level	DL	0.1 / 0.5	μW	Typ / Max.
Equivalent Series Resistance	ESR	90	KΩ	Max.
Temperature Coefficient	K	-0.03	ppm/°C ²	Typ.
Operating Temperature Range	TR	-40~85	°C	
Shunt Capacitance	C0	7	pF	Max.
Storage Temperature Range		-55~125	°C	
Aging		± 3	ppm	Max 1st year
Insulation Resistance		500	MΩ	Min.

Reliability (Mechanical and environmental performances)

No.	Test Items	Conditions	Requirements
1	Bending test	Apply pressure in the direction of the arrow at a rate of about 0.5mm/s until bent width reaches 5mm, and hold for 30 seconds.	<ul style="list-style-type: none">• Without mechanical damage such as breaks and satisfy sealing specification.• Frequency change: Within ±5ppm• Equivalent series resistance(E.S.R) change: Within 5kΩ
2	Shear test	A static load of 20N(2.04kgf) using a R0.5 scratch tool, shall be applied on the core of the component and in the direction of the arrow and held for 5 seconds.	
3	Core body strength	A static load of 10N(1.02kgf) using a R0.5 pressure rod shall be applied to the center in the direction of the arrow and held for 10 seconds.	
4	Vibration	Endurance conditioning by a frequency sweep shall be made. The entire frequency range, from 10Hz to 55Hz and return to 10Hz, shall be transversed in 1 minute. Amplitude (total excursion) : 1.5mm, This motion shall be applied for a period of 2 hours in each of 3 mutually perpendicular axes (a total of 6 hours). For other procedures, refer to JIS C 60068-2-6.	
5	Shock	Peak acceleration : 9810m/s ² · Duration of the pulse : 1ms, Three successive shock shall be applied 3 times perpendicular axes. For other procedures, refer to JIS C 60068-2-27.	

TYPE G9 SMD CRYSTAL

G93270002

VER. C 31-Oct-13

6	Cold	Quartz crystal units shall be stored in the $-40\pm 3^{\circ}\text{C}$ atmosphere for 1000 hours. Other procedures conform to JIS C 60068-2-1.	<ul style="list-style-type: none"> • Frequency change: Within $\pm 5\text{ppm}$ • Equivalent series resistance(E.S.R) change: Within $5\text{k}\Omega$ • After conditioning, quartz crystal units shall be subjected to standard atmospheric conditions for 1 hour, and measured. 														
7	Dry heat	Quartz crystal units shall be stored in the $100\pm 2^{\circ}\text{C}$ atmosphere for 100 hours. Other procedures conform to JIS C 60068-2-2.															
8	Damp heat	Quartz crystal units shall be stored in the $40\pm 2^{\circ}\text{C}$ atmosphere with 90 to 95% relative humidity for 1000 hours. Other procedures conform to JIS C 60068-2-3.															
9	Change of temperature	Quartz crystal units shall be subjected successively 100 cycles of temperature change shown below. Other procedures conform to JIS C 0025. <table border="1" data-bbox="459 768 954 943"> <thead> <tr> <th></th> <th>Temperature</th> <th>Duration</th> </tr> </thead> <tbody> <tr> <td>1</td> <td>$-40\pm 3^{\circ}\text{C}$</td> <td>30min.</td> </tr> <tr> <td>2</td> <td>Normal temperature</td> <td>Within 30 sec.</td> </tr> <tr> <td>3</td> <td>$100\pm 2^{\circ}\text{C}$</td> <td>30min.</td> </tr> <tr> <td>4</td> <td>Normal temperature</td> <td>Within 30 sec.</td> </tr> </tbody> </table>			Temperature	Duration	1	$-40\pm 3^{\circ}\text{C}$	30min.	2	Normal temperature	Within 30 sec.	3	$100\pm 2^{\circ}\text{C}$	30min.	4	Normal temperature
	Temperature	Duration															
1	$-40\pm 3^{\circ}\text{C}$	30min.															
2	Normal temperature	Within 30 sec.															
3	$100\pm 2^{\circ}\text{C}$	30min.															
4	Normal temperature	Within 30 sec.															
10	Sealing	Both the test methods specified below shall be applied.															
		Quartz crystal units shall be soaked in 90°C or higher temperature hot water for 5 minutes.	<ul style="list-style-type: none"> • Without repetitive leaking bubbles from quartz crystal units. 														
		Quartz crystal units shall be tested by Mass spectrometric leakage detector to measure the leakage rate of helium gas.	<ul style="list-style-type: none"> • $1\times 10^{-9}\text{ Pa}\cdot\text{m}^3/\text{s}$ or less 														
11	Aging	Quartz crystal units shall be stored in the $85\pm 3^{\circ}\text{C}$ atmosphere for 720 ± 12 hours.	<ul style="list-style-type: none"> • Frequency change: Within $\pm 5\text{ppm}$ • Equivalent series resistance(E.S.R) change: Within $5\text{k}\Omega$ • After conditioning, quartz crystal units shall be subjected to standard atmospheric conditions for 1 hour, and measured. 														
12	Solder-ability	Terminals coated with flux shall be immersed in the solder bath for 3.5 ± 0.5 seconds.	<ul style="list-style-type: none"> • Minimum 95% of immersed terminal shall be covered with new uniform solder. 														
		<table border="1" data-bbox="459 1532 954 1809"> <thead> <tr> <th></th> <th>Items</th> <th>Conditions</th> </tr> </thead> <tbody> <tr> <td>1</td> <td>Solder</td> <td>Sn-3.0Ag-0.5Cu</td> </tr> <tr> <td>2</td> <td>Flux</td> <td>Approximately 25wt% methanol(JIS K 8891) solution of resin(JIS K 5902).</td> </tr> <tr> <td>3</td> <td>Solder temperature</td> <td>$255\pm 5^{\circ}\text{C}$</td> </tr> </tbody> </table>			Items	Conditions	1	Solder	Sn-3.0Ag-0.5Cu	2	Flux	Approximately 25wt% methanol(JIS K 8891) solution of resin(JIS K 5902).	3	Solder temperature	$255\pm 5^{\circ}\text{C}$		
				Items	Conditions												
1	Solder	Sn-3.0Ag-0.5Cu															
2	Flux	Approximately 25wt% methanol(JIS K 8891) solution of resin(JIS K 5902).															
3	Solder temperature	$255\pm 5^{\circ}\text{C}$															

TYPE G9 SMD CRYSTAL

G93270002

VER. C 31-Oct-13

<p>13</p>	<p>Resistance to soldering heat</p>	<p>Reflow soldering method</p> <p>温度プロファイル Temperature profile</p> <p>Peak temperature: $260 \pm 5^\circ\text{C}$ for within 5seconds. Soldering temperature: 220°C or higher for 60 ± 10 seconds. Pre-heating temperature: $160 \pm 10^\circ\text{C}$ for 90 ± 10 seconds. Quartz crystal units which is put on PCB shall be through reflow soldering furnace twice with the condition shown above.</p>	<ul style="list-style-type: none"> • Frequency change: Within $\pm 5\text{ppm}$ • Equivalent series resistance (E.S.R) change: Within $10\text{k}\Omega$ • After conditioning, quartz crystal units shall be subjected to standard atmospheric conditions for 1 hour, and measured. • Without distinct deformation in appearance.
		<p>Soldering iron method</p> <p>Terminals shall be applied $400 \pm 10^\circ\text{C}$ soldering iron heat for 3.5 ± 0.5 seconds twice.</p>	<ul style="list-style-type: none"> • Frequency change: Within $\pm 5\text{ppm}$ • Equivalent series resistance(E.S.R) change: Within $5\text{k}\Omega$ • After conditioning, quartz crystal units shall be subjected to standard atmospheric conditions for 1 hour, and measured. • Without distinct deformation in appearance.
<p>14</p>	<p>Solubility to resistance</p>	<p>Soak cleaning</p> <p>Quartz crystal units shall be soaked in isopropyl alcohol at normal temperature for 90 seconds.</p>	<ul style="list-style-type: none"> • Without mechanical damage such as breaks and satisfy sealing specification. • Frequency change: Within $\pm 5\text{ppm}$ • Equivalent series resistance(E.S.R) change: Within $5\text{k}\Omega$ • Without distinct deformation in appearance. • Marking shall be legible.

TYPE G9 SMD CRYSTAL

G93270002

VER. C 31-Oct-13

Marking

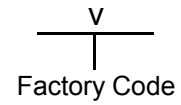
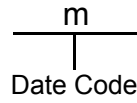
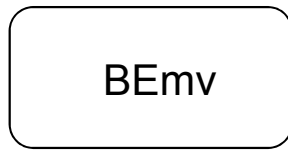

Dimensions (Units: mm)

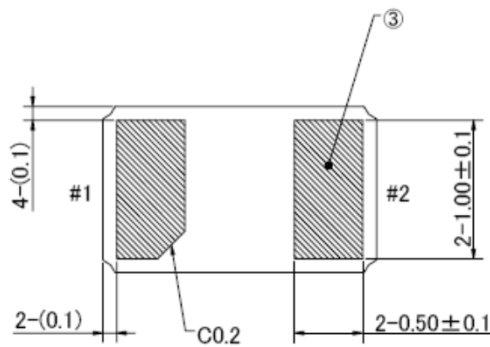
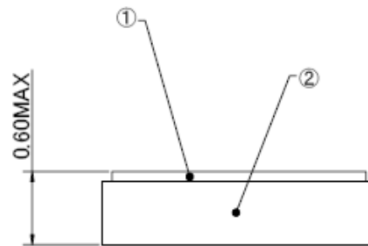
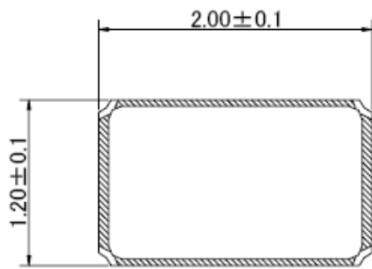

内部接続図
Internal connection

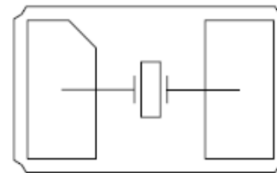

Land dimensions(unit: mm)

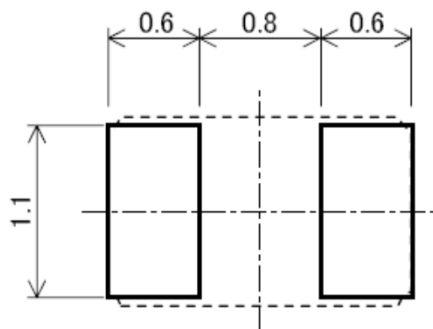

TYPE G9 SMD CRYSTAL

G93270002

VER. C 31-Oct-13

TAPING

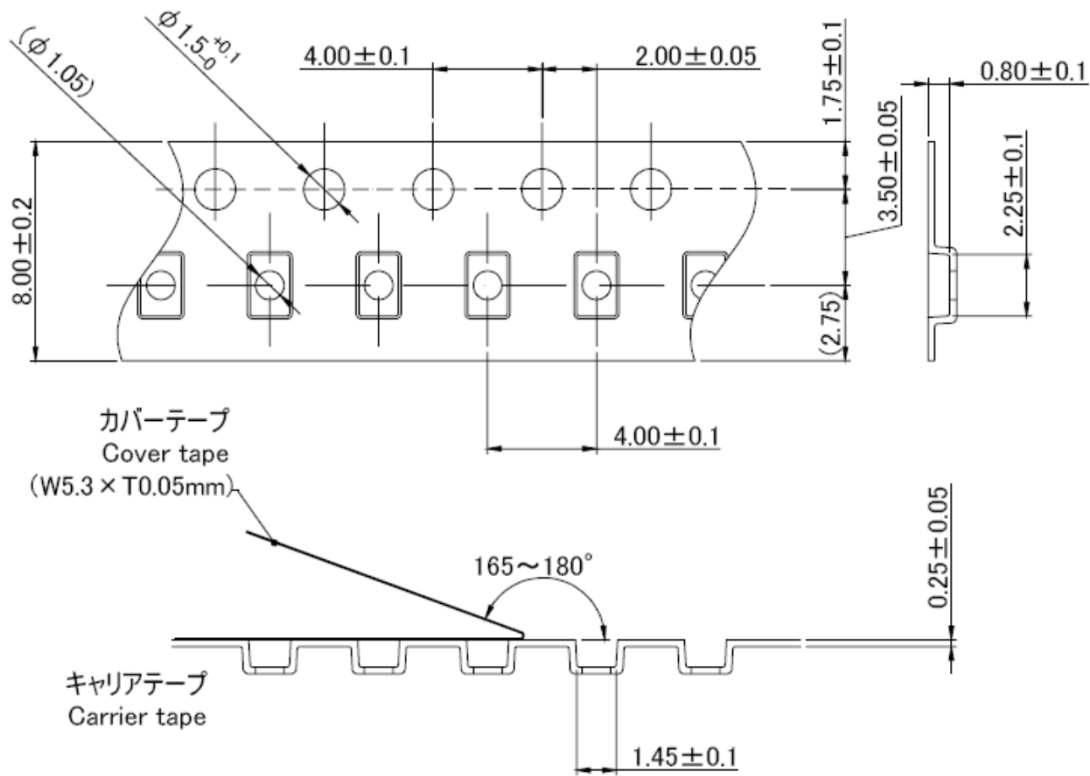

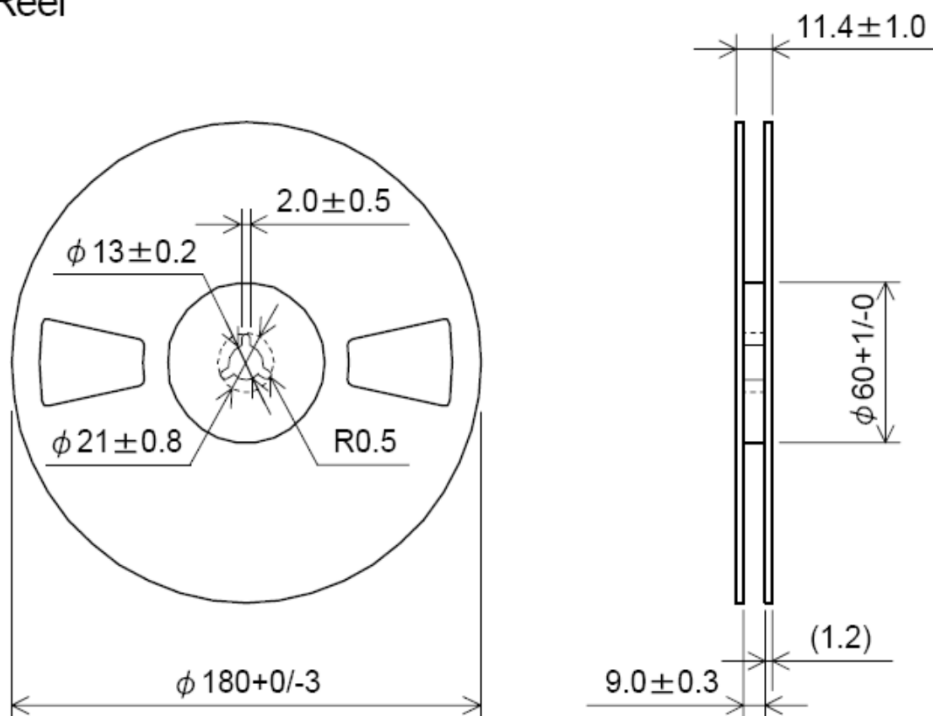

REEL

Reel



Looking for pricing, stock, or lifecycle information?

Click below to explore more details on WIN SOURCE:

-  [View G93270002 on WIN SOURCE](#)
-  [Diodes Incorporated Information](#)

Optimize Your Supply Chain with WIN SOURCE Solutions

-  Global Sourcing Solution
-  Obsolete Management
-  Cost Control Management
-  Shortage Management
-  Alternative Solution
-  Excess Inventory Management