

ECN/PCN No.: 4117

For Manufacturer			
Product Description: PLASTIC SMD MEMS OSCILLATOR	Abracon Part Number / Part Series: ASTMUPC	<input type="checkbox"/> Documentation only <input type="checkbox"/> ECN <input checked="" type="checkbox"/> EOL	<input checked="" type="checkbox"/> Series <input type="checkbox"/> Part Number
Affected Revision: I.R.	New Revision: EOL	Application:	<input type="checkbox"/> Safety <input checked="" type="checkbox"/> Non-Safety
Prior to Change: Active https://abracon.com/Oscillators/ASTMUPC.pdf			
After Change: EOL			
Cause/Reason for Change: Discontinuation of manufacturing capability.			
Change Plan			
Effective Date: 2/7/2022	Additional Remarks: N/A		
Change Declaration: N/A			
Issued Date: 2/7/2022	Issued By: <i>Brooke Cushman</i> Product Engineer	Issued Department: Engineering	
Approval: <i>Thomas Culhane</i> Engineering Director	Approval: <i>Reuben Quintanilla</i> Quality Director	Approval: <i>Ying Huang</i> Purchasing Director	
For Abracon EOL only			
Last Time Buy (if applicable): 5/7/2022	Alternate Part Number / Part Series: ASDDV (2.5x2.0mm), ASEDV (3.2x2.5mm), ASFLDV (5.0x3.2mm), ASVDV (7.0x5.0mm)		
Additional Approval:	Additional Approval:	Additional Approval:	
Customer Approval (If Applicable)			
Qualification Status: <input type="checkbox"/> Approved <input type="checkbox"/> Not accepted <i>Note: It is considered approved if there is no feedback from the customer 1 month after ECN/PCN is released.</i>			
Customer Part Number:		Customer Project:	
Company Name:	Company Representative:	Representative Signature:	
Customer Remarks:			

High Performance, Programmable LVCMOS SMD MEMS Oscillator



ASTMUPC



RoHS/RoHS II compliant

2.7 x 2.4 x 0.75mm; 3.2 x 2.5 x 0.75mm;
5.0 x 3.2 x 0.75mm; 7.0 x 5.0 x 0.9mm

Moisture Sensitivity Level (MSL) – 1

FEATURES:

- Industry Standard package sizes: 2.7 x 2.4 x 0.75mm (compatible with 2520 package footprint), 3.2 x 2.5 x 0.75mm, 5 x 3.2 x 0.75mm, 7.0 x 5.0 x 0.9mm
- Any frequency between 1MHz and 220MHz
- Supply Voltage options: 3.3V, 2.8V, 2.5V, 1.8V
- Ultra-low RMS phase jitter: 0.5ps typ. (@156.25MHz, integration bandwidth: 12kHz to 20MHz)
- Frequency Stability options: ±10ppm, ±20ppm, ±25ppm, ±50ppm over -20 to +70°C and -40 to +85°C
- Factory programmable drive strength (for 1MHz ~80MHz) for improved jitter, reduced EMI or higher capacitive output load

APPLICATIONS:

- Ethernet, SATA, SAS, PCI Express
- WiFi
- Video
- Computing
- Storage
- Networking
- Telecom
- Industrial control
- Harsh environment (vibration, shock-prone and humid)

STANDARD SPECIFICATIONS:

All electrical specifications in this table are specified with 15pF output load and for all V_{dd} options unless otherwise stated.

Parameters		Min	Typ	Max	Unit	Notes
Output Frequency Range (F)		1		220	MHz	
Frequency Stability (F_{stab})		-10		+10	ppm	Inclusive of initial tolerance at 25°C, and variations over operating temperature, rated power supply voltage and load (15pF±10%)
		-20		+20		
		-25		+25		
		-50		+50		
Operating Temperature Range (T_{use})		-20		+70	°C	Option "E"
		-40		+85		Option "L"
Aging@25°C	1 st year	-1.5		+1.5	ppm	
	10 years	-5		+5		
Supply Voltage (V_{dd})		1.71	1.8	1.89	V	Option "18"
		2.25	2.5	2.75		Option "25"
		2.52	2.8	3.08		Option "28"
		2.97	3.3	3.63		Option "33"
Current Consumption (I_{dd})			31	33	mA	No load, F=20MHz, V_{dd} =2.5V, 2.8V, 3.3V
			29	31		No load, F=20MHz, V_{dd} =1.8V
			34	36		No load, F=100MHz, V_{dd} =2.5V, 2.8V, 3.3V
			30	33		No load, F=100MHz, V_{dd} =1.8V
OE Disable Current (I_{OD})				31	mA	V_{dd} =2.5V, 2.8V, 3.3V, OE=GND, output is weakly pulled down
				30		V_{dd} =1.8V, OE=GND, output is weakly pulled down
Standby Current (I_{std})				70	µA	V_{dd} =2.5V, 2.8V, 3.3V, \overline{ST} =GND, output is weakly pulled down
				10		V_{dd} =1.8V, \overline{ST} =GND, output is weakly pulled down
Startup Time (T_{start})			7	10	ms	Measured from the time V_{dd} reaches its rated minimum value
OE Enable/Disable Time (T_{oe})				150	ns	F=80MHz. For other frequencies, T_{oe} =100ns+3*cycles
				115		F=220MHz. For other frequencies, T_{oe} =100ns+3*cycles
Resume Time (T_{resume})			6	10	ms	In standby mode. Measured from the time \overline{ST} pin crosses 50% threshold

High Performance, Programmable LVCMOS SMD MEMS Oscillator



ASTMUPC



RoHS/RoHS II compliant

2.7 x 2.4 x 0.75mm; 3.2 x 2.5 x 0.75mm;
5.0 x 3.2 x 0.75mm; 7.0 x 5.0 x 0.9mm

(Continued)

Parameters	Min	Typ	Max	Unit	Notes
Output Type	LVCMOS				
Duty Cycle	45		55	%	F≤165MHz. All V _{dd} options
	40		60		F>165MHz. All V _{dd} options
Rise/Fall Time (T _r /T _f)		1.2	2	ns	15pF load, 10%-90%
Output High Voltage (V _{OH})	90%*V _{dd}			V	I _{OH} =-6mA (V _{dd} =3.3V, 2.8V, 2.5V)
					I _{OH} =-3mA (V _{dd} =1.8V)
Output Low Voltage (V _{OL})			10%*V _{dd}	V	I _{OL} =6mA (V _{dd} =3.3V, 2.8V, 2.5V)
					I _{OL} =3mA (V _{dd} =1.8V)
Input High Voltage(V _{IH})	70%*V _{dd}			V	Pin 1
Input Low Voltage(V _{IL})			30%*V _{dd}	V	Pin 1
Input Pull-up Impedance (Z _{in})		100	250	kΩ	Pin 1, OE logic high or logic low, \overline{ST} logic high
	2			MΩ	Pin 1, \overline{ST} logic low
RMS Period Jitter (T _{jitt})		1.5	2	ps	F=75MHz, 156.25MHz, V _{dd} =2.5V, 2.8V, 3.3V
		2	3		F=75MHz, 156.25MHz, V _{dd} =1.8V
RMS Phase Jitter (random) (T _{phj})		0.5	1	ps	F=10MHz, 156.25MHz, integration bandwidth=12kHz to 20MHz

Absolute Maximum Ratings

Attempted operation outside the absolute maximum ratings may cause permanent damage to the part. Actual performance of the IC is only guaranteed within the operational specifications, not at absolute maximum ratings.

Parameters	Min.	Max.	Unit
Storage Temperature	-65	150	°C
V _{DD}	-0.5	4	V
Electrostatic Discharge (HBM)		2000	V
Soldering Temperature (follow standard Pb free soldering guidelines)		260	°C
Junction Temperature		150	°C

Thermal Consideration

Package	θJA, 4 Layer Board (°C/W)	θJA, 2 Layer Board (°C/W)	θJC, Bottom (°C/W)
7.0 x 5.0mm	191	263	30
5.0 x 3.2mm	97	199	24
3.2 x 2.5mm	109	212	27
2.7 x 2.4mm ⁽¹⁾	117	222	26

Note : 1. The 2.7 x 2.4mm Package is compatible with 2.5 x 2.0mm footprint.

High Performance, Programmable LVCMOS SMD MEMS Oscillator



ASTMUPC



RoHS/RoHS II compliant

2.7 x 2.4 x 0.75mm; 3.2 x 2.5 x 0.75mm;
5.0 x 3.2 x 0.75mm; 7.0 x 5.0 x 0.9mm

PART IDENTIFICATION:

ASTMUPC [] - [] - [] MHz - [] [] - [] [] - [] []

Package Size
D: 2.7x2.4mm*
E: 3.2x2.5mm
FL: 5.0x3.2mm
V: 7.0x5.0mm

* Compatible with 2.5 x 2.0mm footprint

Output Frequency in MHz
e.g. 7.3728, 125.000

Operating Temp.
E: -20°C ~ +70°C
L: -40°C ~ +85°C

Pin 1 Function
E: Output Enable
S: Standby

Packaging
Blank: Bulk
T: Tape & Reel (1kpcs / reel)
T3: Tape & Reel (3kpcs / reel)

Freq. Stability
Y: ±10ppm
J: ±20ppm
R: ±25 ppm
C: ±50 ppm

Supply Voltage
18: 1.8V±10%
25: 2.5V±10%
28: 2.8V±10%
33: 3.3V±10%

Output Drive Strength (for 1MHz ~ 80MHz only)**	
Blank: Default	W
L	G
A	X
R	K
B	Y
S	Q
D	Z
T	M
E	N
U	P
F	

** See Table 1 to 4 for the Rise/Fall times (10%~90%) at different drive strength and available options

Table 1: $V_{dd}=1.8V$ Rise/Fall Times for Specific C_{LOAD}

Drive Strength Options	Rise/Fall Time Typ. (ns)				
	C_{LOAD}				
	5pF	15pF	30pF	45pF	60pF
L	12.45	17.68	19.48	46.21	57.82
A	6.50	10.27	16.21	23.92	30.73
R	4.38	7.05	11.61	16.17	20.83
B	3.27	5.30	8.89	12.18	15.75
S	2.62	4.25	7.20	9.81	12.65
D	2.19	3.52	6.00	8.31	10.59
T	1.76	3.01	5.14	7.10	9.15
E	1.59	2.59	4.49	6.25	7.98
U	1.49	2.28	3.96	5.55	7.15
F	1.22	2.10	3.57	5.00	6.46
W	1.07	1.88	3.23	4.50	5.87
G	1.01	1.64	2.95	4.12	5.40
X	0.96	1.50	2.74	3.80	4.98
K	0.92	1.41	2.56	3.52	4.64
Y	0.88	1.34	2.39	3.25	4.32
Q	0.86	1.29	2.24	3.04	4.06
Z or Blank (default)	0.82	1.24	2.07	2.89	3.82
M	0.77	1.20	1.94	2.72	3.61
N	0.66	1.15	1.84	2.58	3.41
P	0.51	1.09	1.76	2.45	3.24

Table 2: $V_{dd}=2.5V$ Rise/Fall Times for Specific C_{LOAD}

Drive Strength Options	Rise/Fall Time Typ. (ns)				
	C_{LOAD}				
	5pF	15pF	30pF	45pF	60pF
L	8.68	13.59	18.36	32.70	42.06
A	4.42	7.18	11.93	16.60	21.38
R	2.93	4.78	8.15	11.19	14.59
B	2.21	3.57	6.19	8.55	11.04
S	1.67	2.87	4.94	6.85	8.80
D	1.50	2.33	4.11	5.68	7.33
T	1.06	2.04	3.50	4.84	6.26
E	0.98	1.69	3.03	4.20	5.51
U	0.93	1.48	2.69	3.73	4.92
F	0.90	1.37	2.44	3.34	4.42
W	0.87	1.29	2.21	3.04	4.02
G or Blank (default)	0.67	1.20	2.00	2.79	3.69
X	0.44	1.10	1.86	2.56	3.43
K	0.38	0.99	1.76	2.37	3.18
Y	0.36	0.83	1.66	2.20	2.98
Q	0.34	0.71	1.58	2.07	2.80
Z	0.33	0.65	1.51	1.95	2.65
M	0.32	0.62	1.44	1.85	2.50
N	0.31	0.59	1.37	1.77	2.39
P	0.30	0.57	1.29	1.70	2.28

High Performance, Programmable LVCMOS SMD MEMS Oscillator



ASTMUPC



RoHS/RoHS II compliant

2.7 x 2.4 x 0.75mm; 3.2 x 2.5 x 0.75mm;
5.0 x 3.2 x 0.75mm; 7.0 x 5.0 x 0.9mm

PART IDENTIFICATION:

Table 3: V_{dd}=2.8V Rise/Fall Times for Specific C_{LOAD}

Drive Strength Options	Rise/Fall Time Typ. (ns)				
	C _{LOAD}				
	5pF	15pF	30pF	45pF	60pF
L	7.93	12.69	17.94	30.10	38.89
A	4.06	6.66	11.04	15.31	19.80
R	2.68	4.40	7.53	10.29	13.37
B	2.00	3.25	5.66	7.84	10.11
S	1.59	2.57	4.54	6.27	8.07
D	1.19	2.14	3.76	5.21	6.72
T	1.00	1.79	3.20	4.43	5.77
E	0.94	1.51	2.78	3.84	5.06
U	0.90	1.38	2.48	3.40	4.50
F	0.87	1.29	2.21	3.03	4.05
W	0.62	1.19	1.99	2.76	3.68
G or Blank (default)	0.41	1.08	1.84	2.52	3.36
X	0.37	0.96	1.72	2.33	3.15
K	0.35	0.78	1.63	2.15	2.92
Y	0.33	0.67	1.54	2.00	2.75
Q	0.32	0.63	1.46	1.89	2.57
Z	0.31	0.60	1.39	1.80	2.43
M	0.30	0.57	1.31	1.72	2.30
N	0.30	0.56	1.22	1.63	2.22
P	0.29	0.54	1.13	1.55	2.13

Table 4: V_{dd}=3.3V Rise/Fall Times for Specific C_{LOAD}

Drive Strength Options	Rise/Fall Time Typ. (ns)				
	C _{LOAD}				
	5pF	15pF	30pF	45pF	60pF
L	7.18	11.59	17.24	27.57	35.57
A	3.61	6.02	10.19	13.98	18.10
R	2.31	3.95	6.88	9.42	12.24
B	1.65	2.92	5.12	7.10	9.17
S	1.43	2.26	4.09	5.66	7.34
D	1.01	1.91	3.38	4.69	6.14
T	0.94	1.51	2.86	3.97	5.25
E	0.90	1.36	2.50	3.46	4.58
U	0.86	1.25	2.21	3.03	4.07
F or Blank (default)	0.48	1.15	1.95	2.72	3.65
W	0.38	1.04	1.77	2.47	3.31
G	0.36	0.87	1.66	2.23	3.03
X	0.34	0.70	1.56	2.04	2.80
K	0.33	0.63	1.48	1.89	2.61
Y	0.32	0.60	1.40	1.79	2.43
Q	0.32	0.58	1.31	1.69	2.28
Z	0.30	0.56	1.22	1.62	2.17
M	0.30	0.55	1.12	1.54	2.07
N	0.30	0.54	1.02	1.47	1.97
P	0.29	0.52	0.95	1.41	1.90

CALCULATING MAXIMUM FREQUENCY

Based on the rise and fall time data given in Table 1 through 4, the maximum frequency the oscillator can operate with a guaranteed full swing of the output voltage over temperature is calculated as follows:

$$Max. Frequency = \frac{1}{6 \times T_{r/f}}$$

Example:

Calculate F_{max} of a 1MHz ~ 80MHz device with the following condition:

- V_{dd} = 1.8V (Table 1)
- Capacitive Load = 30pF
- Desired T_{r/f} Time: = 3ns (rise/fall time option code "G")

The F_{max} is 55.5000000MHz.

High Performance, Programmable LVC MOS SMD MEMS Oscillator



ASTMUPC



RoHS/RoHS II compliant

2.7 x 2.4 x 0.75mm; 3.2 x 2.5 x 0.75mm;
5.0 x 3.2 x 0.75mm; 7.0 x 5.0 x 0.9mm

TYPICAL PHASE NOISE

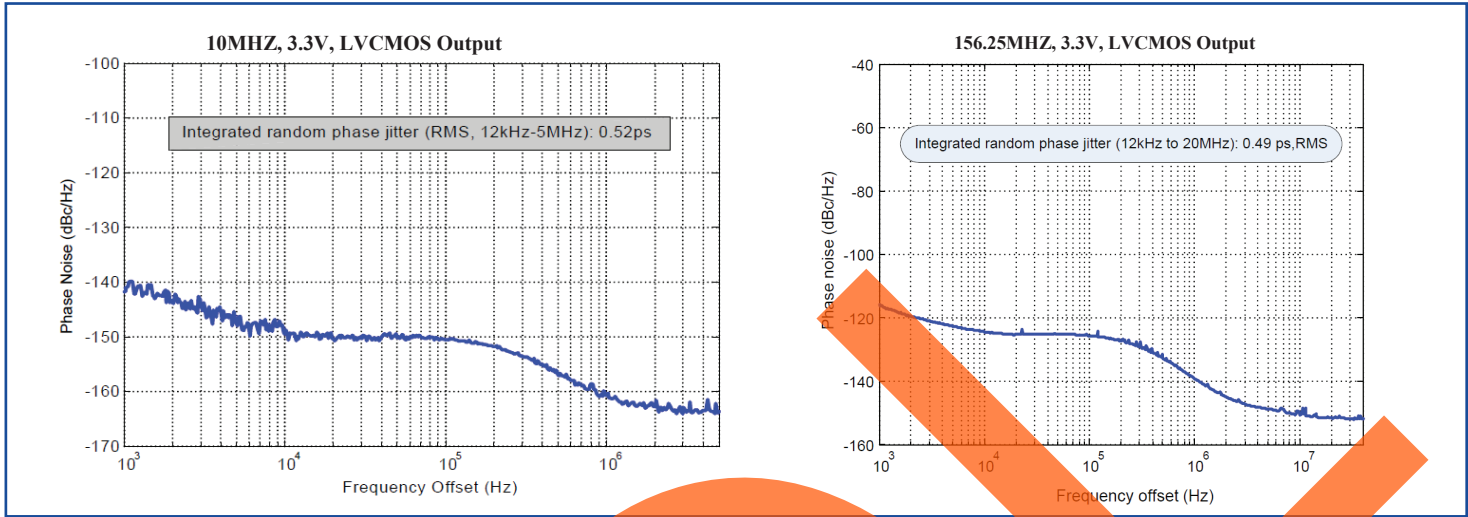

TYPICAL PERFORMANCE DATA

All plots are measured with 15pF load at room temperature, unless otherwise stated.

I_{DD} vs. Frequency

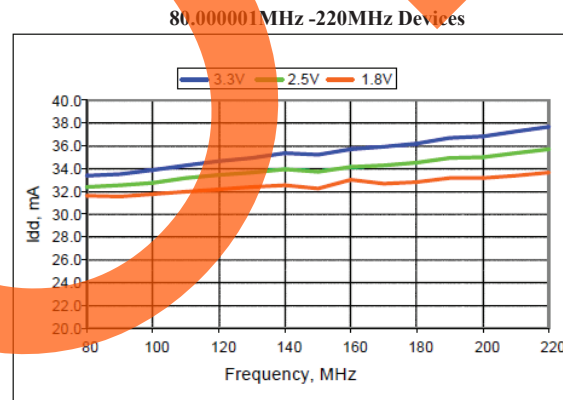
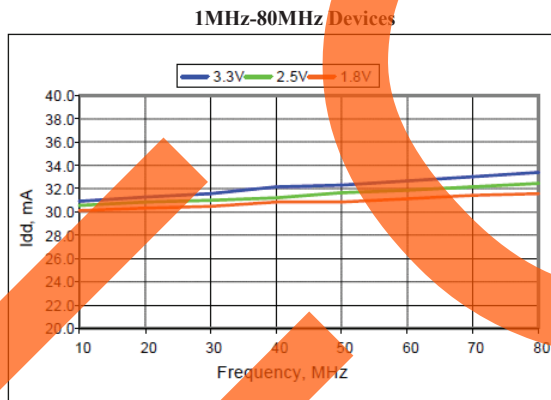

RMS Period Jitter vs. Frequency

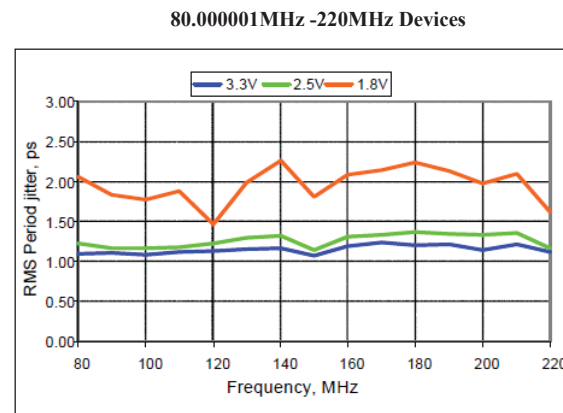
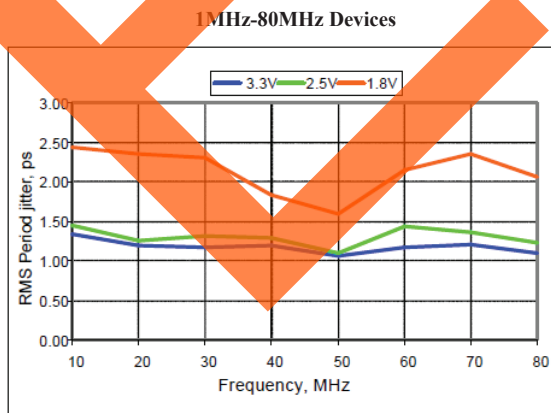

High Performance, Programmable LVCMOS SMD MEMS Oscillator



ASTMUPC



RoHS/RoHS II compliant

2.7 x 2.4 x 0.75mm; 3.2 x 2.5 x 0.75mm;
5.0 x 3.2 x 0.75mm; 7.0 x 5.0 x 0.9mm

TYPICAL PERFORMANCE DATA

Duty Cycle vs. Frequency

1MHz-80MHz Devices

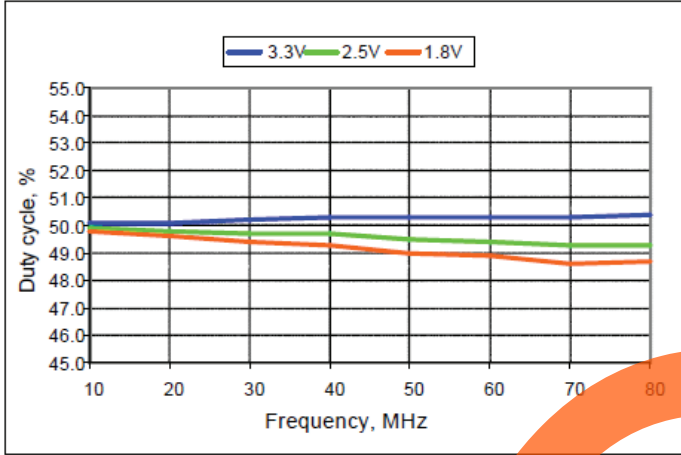

80.000001MHz -220MHz Devices

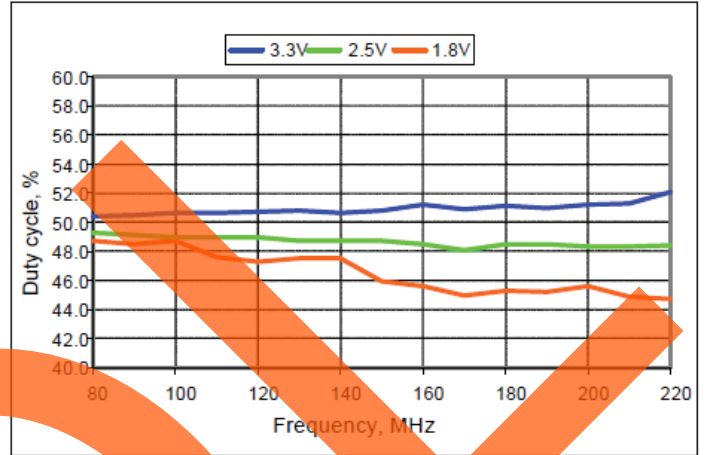

RMS Phase Jitter vs. Frequency

1MHz-80MHz Devices

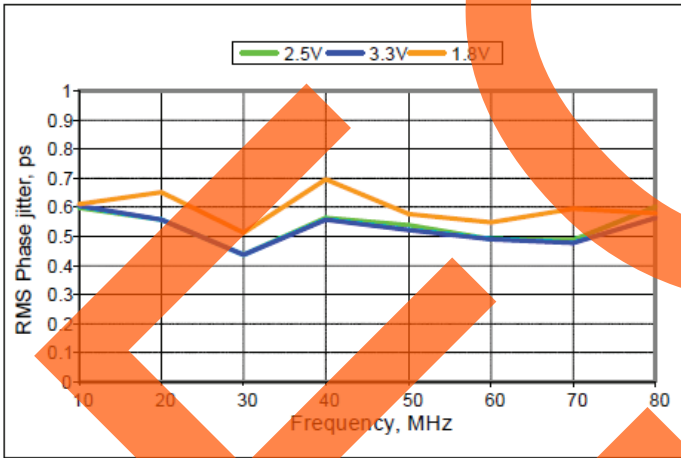

80.000001MHz -220MHz Devices

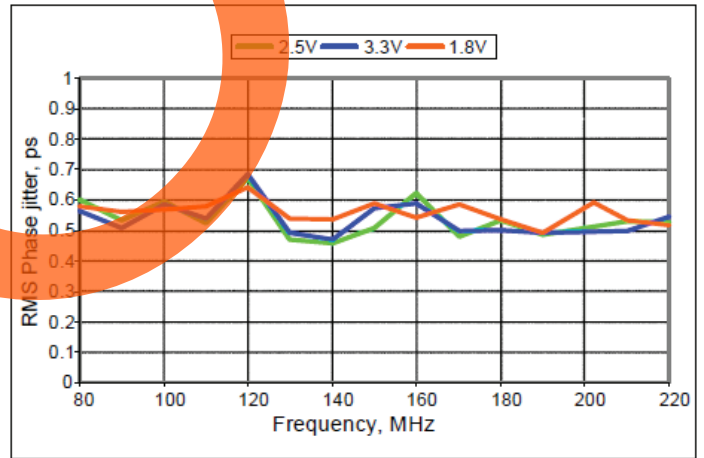



ASTMUPC



RoHS/RoHS II compliant

2.7 x 2.4 x 0.75mm; 3.2 x 2.5 x 0.75mm;
5.0 x 3.2 x 0.75mm; 7.0 x 5.0 x 0.9mm

TYPICAL PERFORMANCE DATA

I_{DD} vs. Temperature

10MHz Devices

100MHz Devices

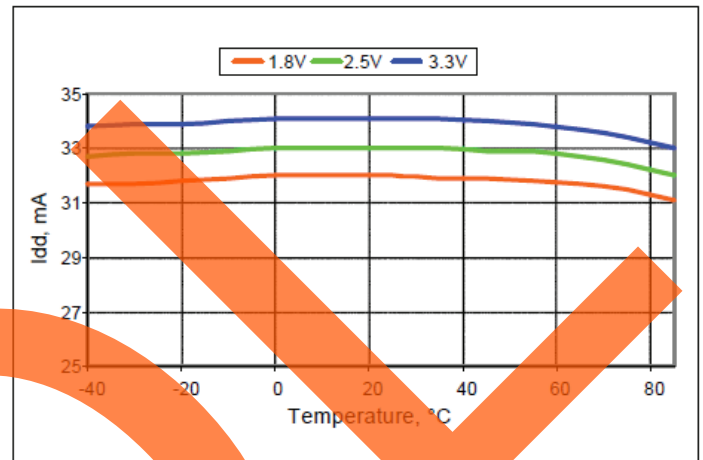
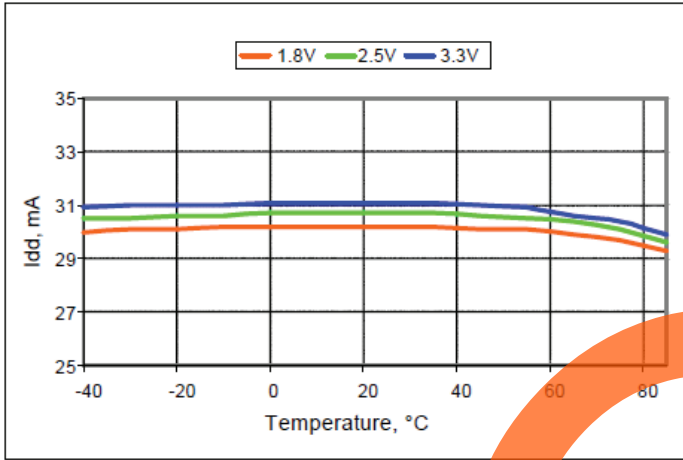

Rise Time vs. Temperature

75MHz Devices

100MHz Devices

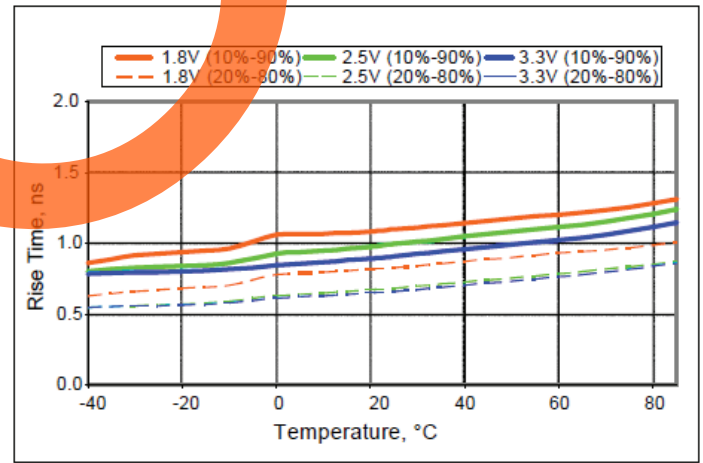
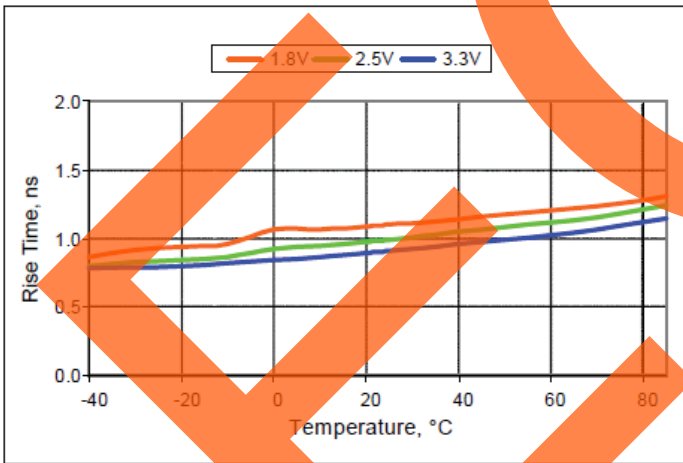

High Performance, Programmable LVCMOS SMD MEMS Oscillator



ASTMUPC



RoHS/RoHS II compliant

2.7 x 2.4 x 0.75mm; 3.2 x 2.5 x 0.75mm;
5.0 x 3.2 x 0.75mm; 7.0 x 5.0 x 0.9mm

OUTLINE DIMENSION:

2.7 x 2.4mm Package (Option "D", compatible with 2.5 x 2.0mm footprint)

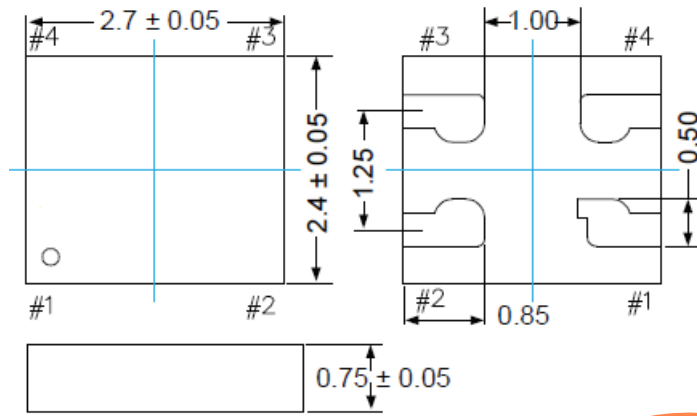

Recommended Land Pattern

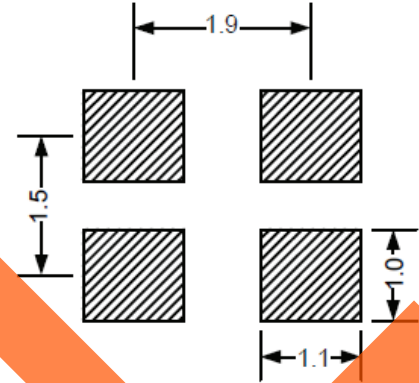

3.2 x 2.5mm Package (Option "E")

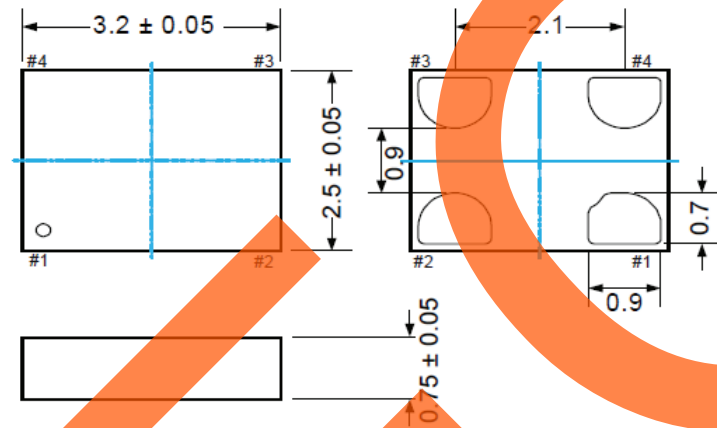

Recommended Land Pattern

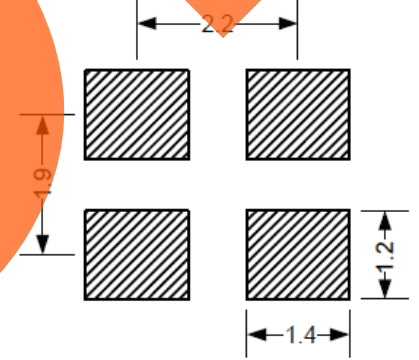

5.0 x 3.2mm Package (Option "FL")

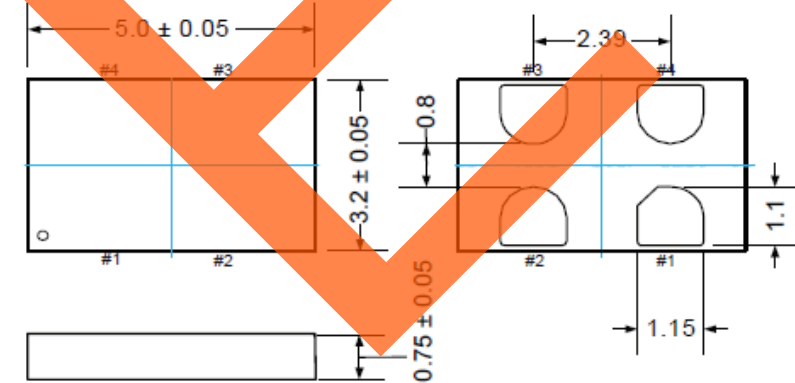

Recommended Land Pattern

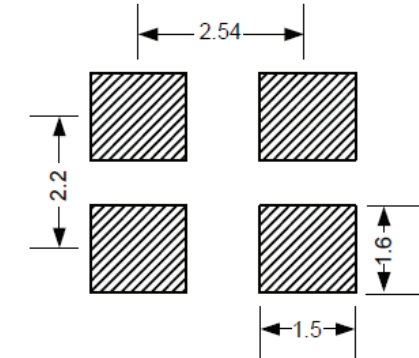

Dimensions: mm

High Performance, Programmable LVCMOS SMD MEMS Oscillator



ASTMUPC



RoHS/RoHS II compliant

2.7 x 2.4 x 0.75mm; 3.2 x 2.5 x 0.75mm;
5.0 x 3.2 x 0.75mm; 7.0 x 5.0 x 0.9mm

OUTLINE DIMENSION:

7.0 x 5.0mm Package (Option "V")

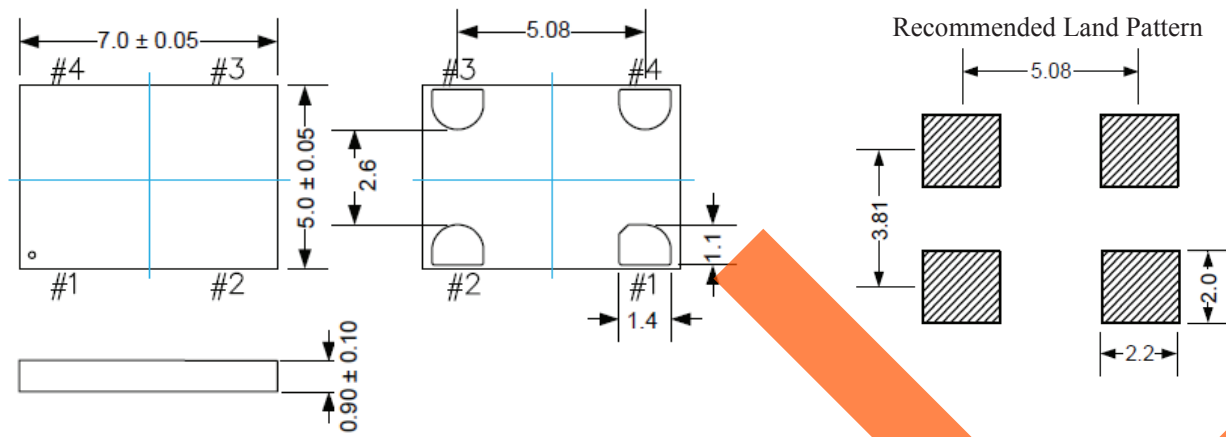

Pin	Name	Functionality
1	Output Enable	H or Open ⁽¹⁾ : specified frequency output L: output is high impedance. Only output driver is disabled
	Standby	H or Open ⁽¹⁾ : specified frequency output L: output is low (weak pull down). Device goes to sleep mode. Supply current reduces to I _{std} .
2	GND	Power Electrical ground ⁽²⁾
3	Out	Output Oscillator clock output
4	V _{dd}	Power Power supply voltage ⁽²⁾

Notes: 1. A pull-up resistor of <10kΩ between OE/ST pin and V_{dd} is recommended in high noise environment.
2. A capacitor value of 0.1μF between V_{dd} and GND is recommended.

Dimensions: mm

REFLOW PROFILE:

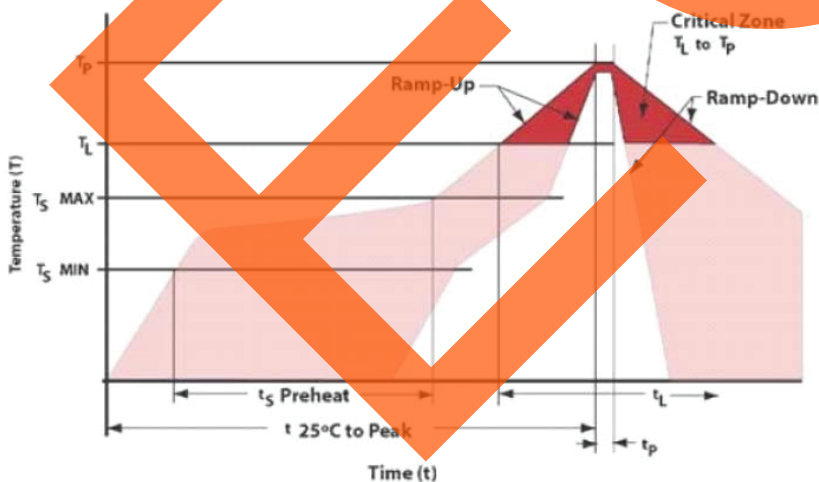

Item	Conditions
T _S MAX to T _L (Ramp-up Rate)	3°C/second max
Preheat	
Temperature Minimum (T _S MIN)	150°C
Temperature Typical (T _S TYP)	175°C
Temperature Maximum (T _S MAX)	200°C
Time (t _S)	60 – 180 seconds
Ramp-up Rate (T _L to T _p)	3°C/second max
Time Maintained Above	
Temperature (T _L)	217°C
Time (t _L)	60 – 150 seconds
Peak Temperature (T _p)	260°C max
Target Peak Temperature (T _p Target)	255°C
Time within 5°C of actual peak (t _p)	20 – 40 seconds
Max. Number of Reflow Cycles	3
Ramp-down Rate	6°C/second max
Time 25°C to Peak Temperature (t)	8 minutes max

High Performance, Programmable LVCMOS SMD MEMS Oscillator



ASTMUPC



RoHS/RoHS II compliant

2.7 x 2.4 x 0.75mm; 3.2 x 2.5 x 0.75mm;
5.0 x 3.2 x 0.75mm; 7.0 x 5.0 x 0.9mm

TAPE & REEL:

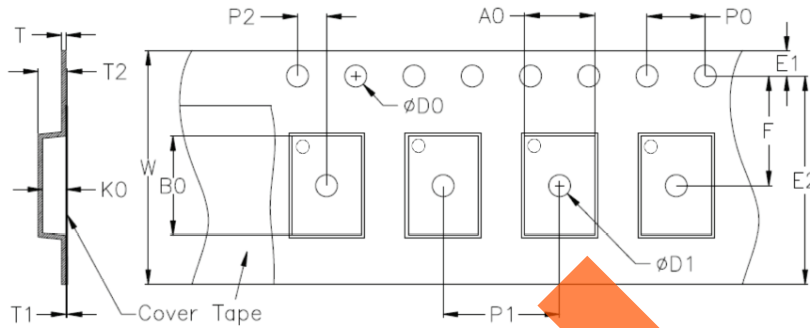

Unit: mm

Device Size	D0	D1 min.	E1	E2 min.	F	P0	P1	P2
2724	1.55±0.05	1.0	1.75±0.1	9.85	5.5±0.05	4.0±0.1	4.0±0.1	2.0±0.05
3225	1.5+0.1/-0.0	1.5	1.75±0.1	10.25	5.5±0.05	4.0±0.1	4.0±0.1	2.0±0.05
5032	1.5+0.1/-0.0	1.5	1.75±0.1	10.25	5.5±0.05	4.0±0.1	8.0±0.1	2.0±0.05
7050	1.5+0.1/-0.0	1.5	1.75±0.1	14.25	7.5±0.1	4.0±0.1	8.0±0.1	2.0±0.1

Unit: mm

Device Size	T	T1 max.	T2 max.	W max.	A0	B0	K0
2724	0.3±0.05	0.1	1.55	12.3	2.65±0.10	2.95±0.10	1.00±0.10
3225	0.6	0.1	1.65	12.3	2.8±0.10	3.5±0.10	1.10±0.10
5032	0.6	0.1	1.65	12.3	3.5±0.10	5.3±0.10	1.10±0.10
7050	0.6	0.1	1.80	16.3	5.4±0.10	7.4±0.10	1.3±0.10

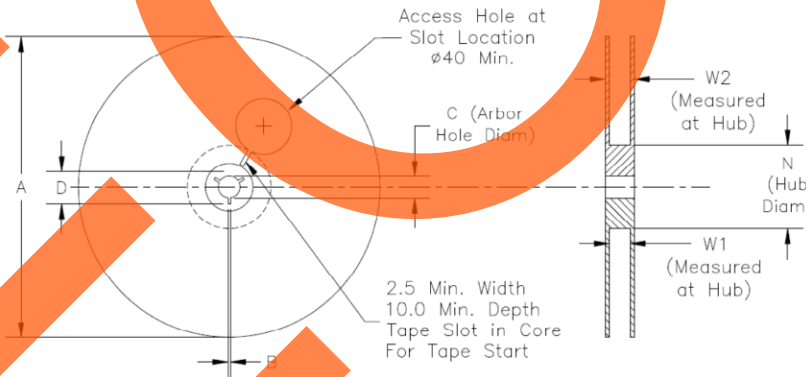

Unit: mm

Tape Size	A max.	B min.	C	D min.	N	W1	W2 max.
12mm	180	1.5	13.0±0.2	20.2	60±0.5	12.4+2.0/-0	18.4
	330	1.5	13.0±0.2	20.2	100±0.5	12.4+2.0/-0	18.4
16mm	180	1.5	13.0±0.2	20.2	60±0.5	16.4+2.0/-0	22.4
	330	1.5	13.0±0.2	20.2	100±0.5	16.4+2.0/-0	22.4

Device Size	"T" (1k/reel)		"T3" (3k/reel)	
2724	12mm Tape	7" Reel	12mm Tape	7" Reel
3225	12mm Tape	7" Reel	12mm Tape	7" Reel
5032	12mm Tape	7" Reel	12mm Tape	13" Reel
7050	16mm Tape	7" Reel	16mm Tape	13" Reel

ATTENTION: Abracon LLC's products are COTS – Commercial-Off-The-Shelf products; suitable for Commercial, Industrial and, where designated, Automotive Applications. Abracon's products are not specifically designed for Military, Aviation, Aerospace, Life-dependent Medical applications or any application requiring high reliability where component failure could result in loss of life and/or property. For applications requiring high reliability and/or presenting an extreme operating environment, written consent and authorization from Abracon LLC is required. Please contact Abracon LLC for more information.

Looking for pricing, stock, or lifecycle information?

Click below to explore more details on WIN SOURCE:

- ⊖ [View ASTMUPCE-33-25.000MHZ-LJ-E-T on WIN SOURCE](#)
- ⊖ [Abracon LLC Information](#)

Optimize Your Supply Chain with WIN SOURCE Solutions

- ✓ Global Sourcing Solution
- ✓ Obsolete Management
- ✓ Cost Control Management
- ✓ Shortage Management
- ✓ Alternative Solution
- ✓ Excess Inventory Management