



**THE DATASHEET OF
PA4339.101NLT**



SMT Common Mode Choke

PA4339.XXXNLT Series



- ⊕ **Height:** 3.8 mm MAX
- ⊕ **Footprint:** 7.5 mm x 6.5 mm MAX
- ⊕ **Rated Current:** up to 9.0 A
- ⊕ **Rated Voltage (MAX):** 80Vdc between windings.

Electrical Specifications @ 25°C - Operating Temperature -40°C to 125°C

Part Number	Inductance (uH ± 50%)	Rated Current (A)	DCR/Winding (mOHms Max)	Impedance @ 100 MHz (ohms)		SRF (MHz)
				MIN	TYP	TYP
PA4339.101NLT	1.8	9.0	10	100	140	200
PA4339.301NLT	2.8	5.0	10	225	300	138
PA4339.501NLT	4.0	5.0	10	275	350	124
PA4339.701NLT	5.0	4.0	15	500	700	108
PA4339.102NLT	8.0	3.0	17	800	1020	93
PA4339.132NLT	9.0	2.5	21	910	1300	77

Notes:

- The temperature of the component (ambient plus temperature rise) must be within the stated operating temperature range.
- The current rating (I_{rated}) is based upon the temperature rise of the component and represents the rms current which will cause a typical temperature rise of 40°C.
- Inductance value is only for reference and is measured at 100kHz, 100Vrms.

Mechanical

Schematic

PA4339.XXXNLT

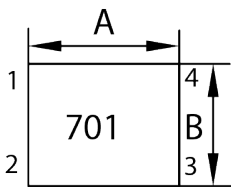

FINAL LAYOUT

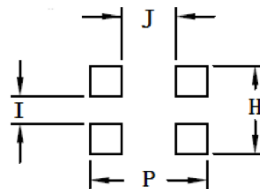
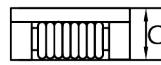
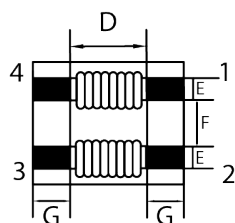

SUGGESTED PAD LAYOUT

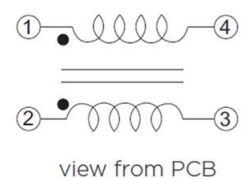

SERIES	A	B	C	D	E	F	G	I	H	J	P
PA4339.XXXNLT	7.0±0.5mm	6.0±0.5mm	MAX 3.8 mm	3.5mm	1.5±0.2mm	1.5±0.2mm	1.75±0.2mm	1.5mm	4.5mm	2.5mm	8.0mm

All Dimensions in mm.

SMT Common Mode Choke

PA4339.XXXNLT Series

PA4339.XXXNLT, Typical Impedance versus Frequency

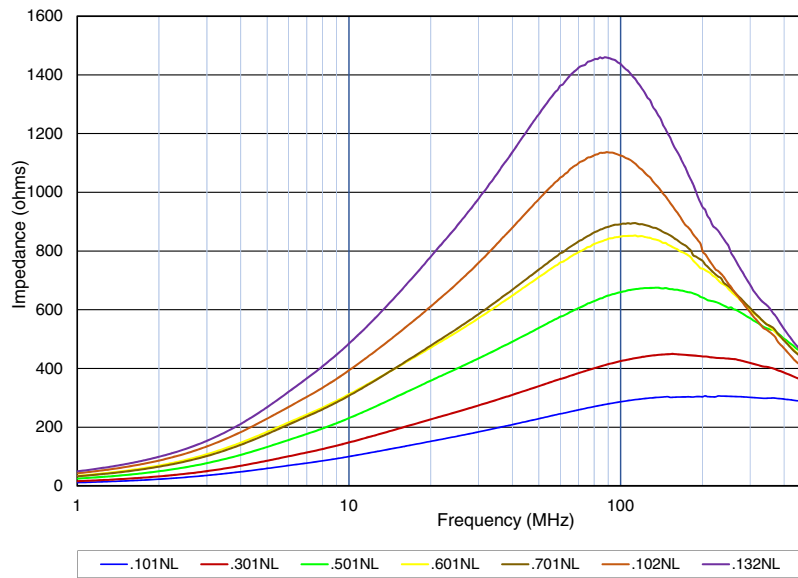

TAPE & REEL INFO

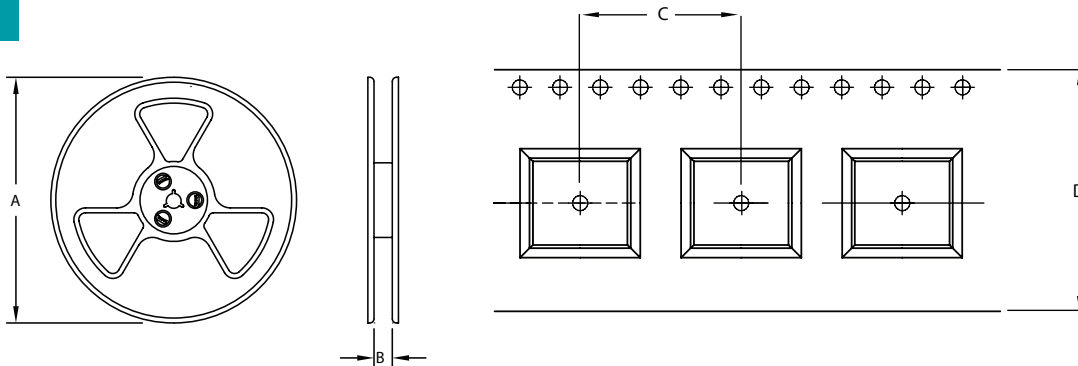

SURFACE MOUNTING TYPE, REEL/TAPE LIST

SERIES	REEL SIZE (mm)		TAPE SIZE (mm)		QTY
	A	B	C	D	PCS/REEL
PA4339.XXXNLT	Ø330	16.4	12.0±0.1	16.0±0.3	1500

For More Information

Americas - proinfo_power_americas@yageo.com | Europe - proinfo_power_emea@yageo.com | Asia - proinfo_power_asia@yageo.com

Performance warranty of products offered on this data sheet is limited to the parameters specified. Data is subject to change without notice. Other brand and product names mentioned herein may be trademarks or registered trademarks of their respective owners. © Copyright, 2023. Pulse Electronics, Inc. All rights reserved.

YAGEO Corporation and its affiliates do not recommend the use of commercial or automotive grade products for high reliability applications or manned space flight.

Looking for pricing, stock, or lifecycle information?

Click below to explore more details on WIN SOURCE:

 [View PA4339.101NLT on WIN SOURCE](#)

 [Pulse Information](#)

Optimize Your Supply Chain with WIN SOURCE Solutions

-  Global Sourcing Solution
-  Obsolete Management
-  Cost Control Management
-  Shortage Management
-  Alternative Solution
-  Excess Inventory Management