

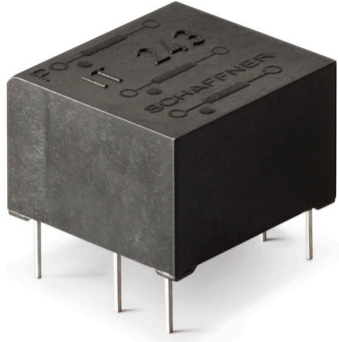

**THE DATASHEET OF
IT234**



Pulse Transformer with Double Secondary Winding



- Galvanic separation of drive and power circuit
- Voltage resistance up to 4 kV
- Ignition current up to 1 A
- Turns ratio up to 3:1:1

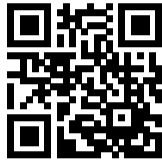

Approvals & Compliances

RoHS

Features and Benefits

- Galvanic separation with secondary winding
- Voltage resistance up to 4 kV
- Allows high potential difference voltage scaling
- Vacuum potting
- Very low partial discharge effects
- PCB through hole mounting
- Custom-specific versions on request

Typical Applications

- Gate drive circuit
- Power supplies
- Power converters
- Frequency converters
- Switching applications
- DC/DC converters
- Line coupling transformers in high-speed data transmission

Technical Specifications

Nominal operating voltage	Up to 500 V
Operating frequency	40 kHz max. 500 kHz max. for data transmission DC to 40000 Hz
Ignition currents	0.025 to 1 A @ 40°C
Rise time	0.4 to 4 μs
Test voltage	Up/50 Hz/2 s max. according to VDE 110b
Max. partial discharge voltage	1.5 x Unom
Temperature range (operation and storage)	-25°C to +70°C (25/70/21)
Flammability corresponding to	UL 94 V-0 listed materials

Pulse Transformer Selection Table

Pulse transformer	Turns ratio	Ignition current I_{ign} [A]	Voltage		Voltage time area V_{ot} [V μ s]	Rise time t_r [μ s]	Inductance *		Resistance		Coupling capacitance C_k [pF]	Input/Output connections	Weight [g]
			U_{nom} [V]	U_p [kV]			L_p [mH]	L_{str} [μ H]	R_p [Ω]	R_s [Ω]			
IT 143	1:1:1	0.025	500	4	800	0.6	15	200	3	3	10	02	14
IT 242	1:1:1	0.1	500	3.2	250	0.9	2.5	75	0.75	0.75	7	02	6
IT 243	1:1:1	0.1	500	3.2	250	1	2.5	85	0.8	0.8	7	02	6
IT 213	1:1:1	0.25	380	2.5	450	0.4	6.5	20	1.4	1.4	40	02	9
IT 233	1:1:1	0.25	500	4	300	1.3	3	45	0.8	0.8	7	02	13
IT 253	1:1:1	0.25	500	3.2	160	1.3	1.1	45	0.55	0.55	6	02	6
IT 312	1:1:1	0.25	380	2.5	1200	1	21	35	2.4	2.7	30	02	24
IT 313	1:1:1	1	380	2.5	450	0.6	3	6	0.33	0.4	27	02	24
IT 249	2:1:1	0.25	500	3.2	330	4	17	140	3.1	1.5	9	02	6
IT 244	3:1:1	0.1	500	3.2	200	0.7	15	70	2.8	0.9	9	02	6
IT 234	3:1:1	0.25	500	4	280	1	17	40	2	0.7	9	02	13
IT 314	3:1:1	1	380	2.5	500	1	35	20	1.6	0.7	30	02	25

* Tolerance: +50%; -30%

Explanations:

- t_r rise time at given load resistor R and 70% of the output pulse height.

- L_p primary inductance measured at 1 kHz (secondary coil open).

- L_{str} stray inductance measured at the secondary side, short circuit at the primary side. If there are several secondary coils only one at the time is connected (measuring frequency 10 kHz).

- The ignition current is a set peak value where the voltage drop over the coil resistance is still insignificant (mostly below 1 V).

Mechanical Data

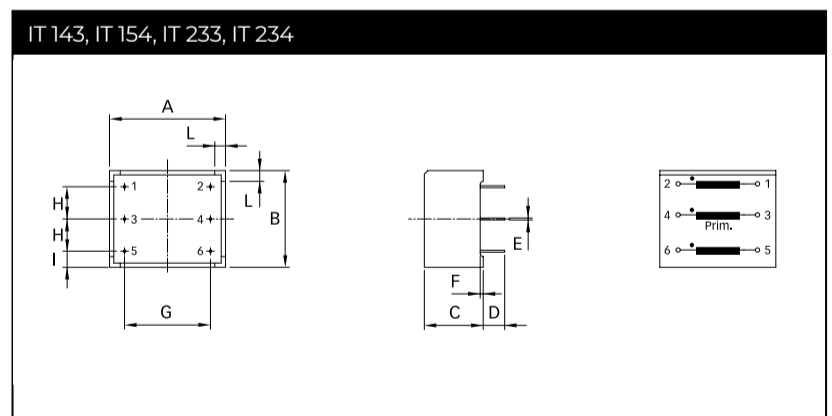
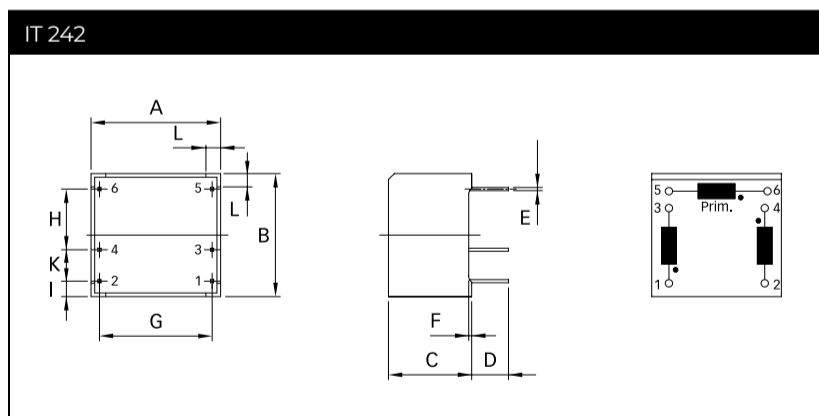
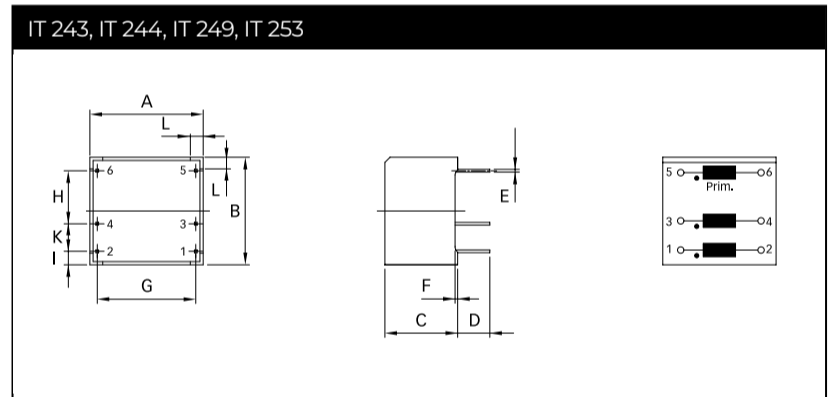
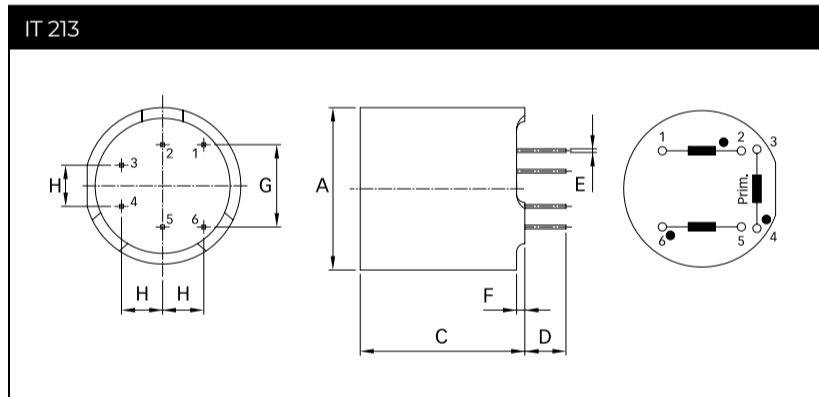

IT 312, IT 313, IT 314

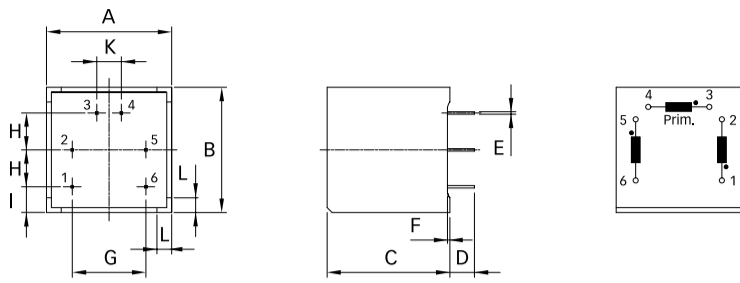

Dimensions

	IT 213	IT 243	IT 244	IT 249	IT 253	IT 242	IT 143	IT 154	IT 233	IT 234	IT 312	IT 313	IT 314	Tol.
A	∅19	17.6	17.6	17.6	17.6	17.6	27*	27*	27*	27*	25.5*	25.5*	25.5*	±0.1
B		16.7	16.7	16.7	16.7	16.7	22.5*	22.5*	22.5*	22.5*	25.5*	25.5*	25.5*	±0.1
C	20	11.3	11.3	11.3	11.3	11.3	13.7	13.7	13.7	13.7	25*	25*	25*	±0.1
D	5	5	5	5	5	5	5	5	5	5	5	5	5	+1/-0
E	0.45	0.42	0.42	0.42	0.42	0.42	0.45	0.45	0.45	0.45	0.5	0.5	0.5	
F	1	0.4	0.4	0.4	0.4	0.4	0.7	0.7	0.7	0.7	0.5	0.5	0.5	
G	10	15.3	15.3	15.3	15.3	15.3	20	20	20	20	15	15	15	
H	5	7.5	7.5	7.5	7.5	7.5	7.5	7.5	7.5	7.5	7.5	7.5	7.5	±0.2
I		2.1	2.1	2.1	2.1	2.1	3.75	3.75	3.75	3.75	5.25	5.25	5.25	±0.2
K		5	5	5	5	5					5	5	5	±0.2
L		2	2	2	2	2	2.5	2.5	2.5	2.5	3	3	3	

* Tolerance is ±0.2

All dimensions in mm; 1 inch = 25.4 mm

Tolerances according: ISO 2768-m/EN 22768-m

Please visit www.schaffner.com to find more details on filter connectors.

Headquarters, Global Innovation and Development

Switzerland

Schaffner Holding AG

Industrie Nord
Nordstrasse 11e
4542
Luterbach
+41 32 681 66 26
info@schaffner.com

Sales and Application Centers

China

Schaffner EMC Ltd. Shanghai

T20-3 C, No 565 Chuangye Road, Pudong district
201201
Shanghai
+86 2138139500
cschina@schaffner.com

Finland

Schaffner Oy

Sauvonrinne 19 H
8500
Lohja
+358 50 468 7284
finlandsales@schaffner.com

France

Schaffner EMC S.A.S.

16-20 Rue Louis Rameau
95875
Bezons
+33 1 34 34 30 60
francesales@schaffner.com

Germany

Schaffner Deutschland GmbH

Schoemperlenstrasse 12B
76185
Karlsruhe
+49 721 56910
germanysales@schaffner.com

India

Schaffner India Pvt. Ltd

Regus World Trade Centre
WTC, 22nd Floor Unit No 2238, Brigade Gateway Campus, 26/1, Dr. Rajkumar Road Malleshwaram (W)
560055
Bangalore
+91 8067935355
indiasales@schaffner.com

Italy

Schaffner EMC S.r.l.

Via Ticino, 30
20900
Monza (MB)
+39 039 21 41 070
italysales@schaffner.com

Japan

Schaffner EMC K.K.

ISM Sangenjaya 7F
1-32-12 Kamiuma, Setagaya-ku
154-0011
Tokyo
+81 3 5712 3650
japansales@schaffner.com

Singapore

Schaffner EMC Pte Ltd.

Blk 3015A Ubi Road 1, #05-09, Kampong Ubi Industrial Estate
408705
Singapore
+65 63773283
singaporesales@schaffner.com

Spain

Schaffner EMC España

Calle Caléndula 93, Miniparc III, Edificio E El Soto de Moraleja, Alcobendas
28109
Madrid
+34 917 912 900
spainsales@schaffner.com

Sweden

Schaffner EMC AB

Östermalmstrorg 1
114 42
Stockholm
+46 8 5050 2425
swedensales@schaffner.com

Switzerland

Schaffner EMV AG

Industrie Nord
Nordstrasse 11e
4542
Luterbach
+41 32 681 66 26
switzerlandsales@schaffner.com

Taiwan

Schaffner EMV Ltd.

U-Town
20 Floor-2, No 97, Section 1, XinTai 5th Road, XiZhi District
22175
New Taipei City
+886 226975500
taiwansales@schaffner.com

Thailand

Schaffner EMC Co. Ltd.

Sathorn Square Tower
Room 3780, 37FL, 98 North-Sathorn Rd, Silom, Bangrak
10500
Bangkok
+66 621056397
thailandsales@schaffner.com

United Kingdom

Schaffner Ltd.

1, Oakmede Place
Terrace Road
RG42 4JF
Binfield
+44 118 9770070
uksales@schaffner.com

United States

Schaffner EMC Inc.

52 Mayfield Avenue
Edison, New Jersey
+1 732 225 9533
usasales@schaffner.com

To find your local partner within Schaffner's global network schaffner.com

© 2022 Schaffner Group

The content of this document has been carefully checked and understood. However, neither Schaffner nor its subsidiaries assume any liability whatsoever for any errors or inaccuracies of this document and the consequences thereof. Published specifications are subject to change without notice. Product suitability for any area of application must ultimately be determined by the customer. In all cases, products must never be operated outside their published specifications. Schaffner does not guarantee the availability of all published products. This disclaimer shall be governed by substantive Swiss law and resulting disputes shall be settled by the courts at the place of business of Schaffner Holding AG. Latest publications and a complete disclaimer can be downloaded from the Schaffner website. All trademarks recognized.

Looking for pricing, stock, or lifecycle information?

Click below to explore more details on WIN SOURCE:

- [View IT234 on WIN SOURCE](#)
- [Schaffner EMC Inc. Information](#)

Optimize Your Supply Chain with WIN SOURCE Solutions

- ✓ Global Sourcing Solution
- ✓ Obsolete Management
- ✓ Cost Control Management
- ✓ Shortage Management
- ✓ Alternative Solution
- ✓ Excess Inventory Management