

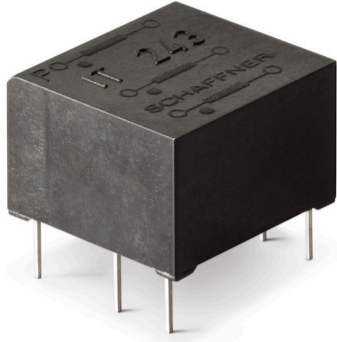

**THE DATASHEET OF  
IT244**



# Pulse Transformer with Double Secondary Winding



- Galvanic separation of drive and power circuit
- Voltage resistance up to 4 kV
- Ignition current up to 1 A
- Turns ratio up to 3:1:1

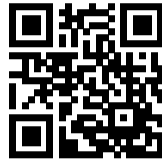

## Approvals & Compliances

### RoHS

### Features and Benefits

- Galvanic separation with secondary winding
- Voltage resistance up to 4 kV
- Allows high potential difference voltage scaling
- Vacuum potting
- Very low partial discharge effects
- PCB through hole mounting
- Custom-specific versions on request

### Typical Applications

- Gate drive circuit
- Power supplies
- Power converters
- Frequency converters
- Switching applications
- DC/DC converters
- Line coupling transformers in high-speed data transmission

## Technical Specifications

<b>Nominal operating voltage</b>	Up to 500 V
<b>Operating frequency</b>	40 kHz max. 500 kHz max. for data transmission DC to 40000 Hz
<b>Ignition currents</b>	0.025 to 1 A @ 40°C
<b>Rise time</b>	0.4 to 4 μs
<b>Test voltage</b>	Up/50 Hz/2 s max. according to VDE 110b
<b>Max. partial discharge voltage</b>	1.5 x Unom
<b>Temperature range (operation and storage)</b>	-25°C to +70°C (25/70/21)
<b>Flammability corresponding to</b>	UL 94 V-0 listed materials

### Pulse Transformer Selection Table

Pulse transformer	Turns ratio	Ignition current $I_{ign}$ [A]	Voltage		Voltage time area $V_{ot}$ [V $\mu$ s]	Rise time $t_r$ [ $\mu$ s]	Inductance *		Resistance		Coupling capacitance $C_k$ [pF]	Input/Output connections	Weight [g]
			$U_{nom}$ [V]	$U_p$ [kV]			$L_p$ [mH]	$L_{str}$ [ $\mu$ H]	$R_p$ [ $\Omega$ ]	$R_s$ [ $\Omega$ ]			
IT 143	1:1:1	0.025	500	4	800	0.6	15	200	3	3	10	02	14
IT 242	1:1:1	0.1	500	3.2	250	0.9	2.5	75	0.75	0.75	7	02	6
IT 243	1:1:1	0.1	500	3.2	250	1	2.5	85	0.8	0.8	7	02	6
IT 213	1:1:1	0.25	380	2.5	450	0.4	6.5	20	1.4	1.4	40	02	9
IT 233	1:1:1	0.25	500	4	300	1.3	3	45	0.8	0.8	7	02	13
IT 253	1:1:1	0.25	500	3.2	160	1.3	1.1	45	0.55	0.55	6	02	6
IT 312	1:1:1	0.25	380	2.5	1200	1	21	35	2.4	2.7	30	02	24
IT 313	1:1:1	1	380	2.5	450	0.6	3	6	0.33	0.4	27	02	24
IT 249	2:1:1	0.25	500	3.2	330	4	17	140	3.1	1.5	9	02	6
IT 244	3:1:1	0.1	500	3.2	200	0.7	15	70	2.8	0.9	9	02	6
IT 234	3:1:1	0.25	500	4	280	1	17	40	2	0.7	9	02	13
IT 314	3:1:1	1	380	2.5	500	1	35	20	1.6	0.7	30	02	25

\* Tolerance: +50%; -30%

Explanations:

- $t_r$  rise time at given load resistor R and 70% of the output pulse height.
- $L_p$  primary inductance measured at 1 kHz (secondary coil open).
- $L_{str}$  stray inductance measured at the secondary side, short circuit at the primary side. If there are several secondary coils only one at the time is connected (measuring frequency 10 kHz).
- The ignition current is a set peak value where the voltage drop over the coil resistance is still insignificant (mostly below 1 V).

### Mechanical Data

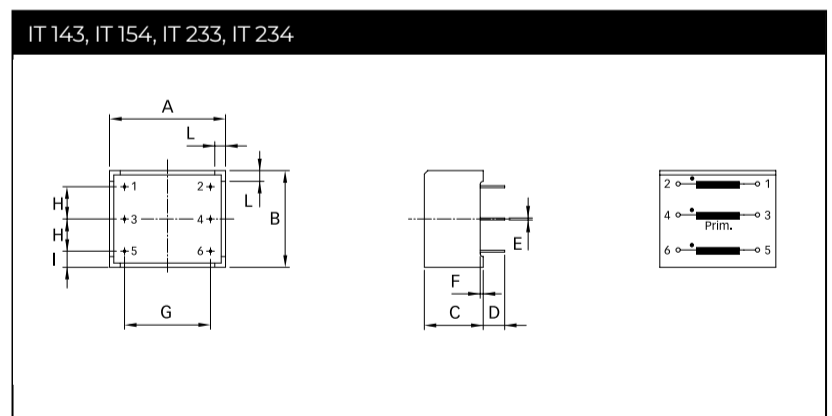
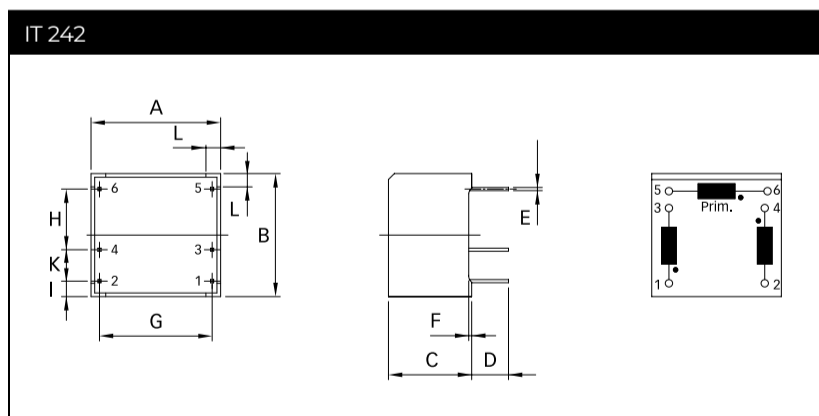
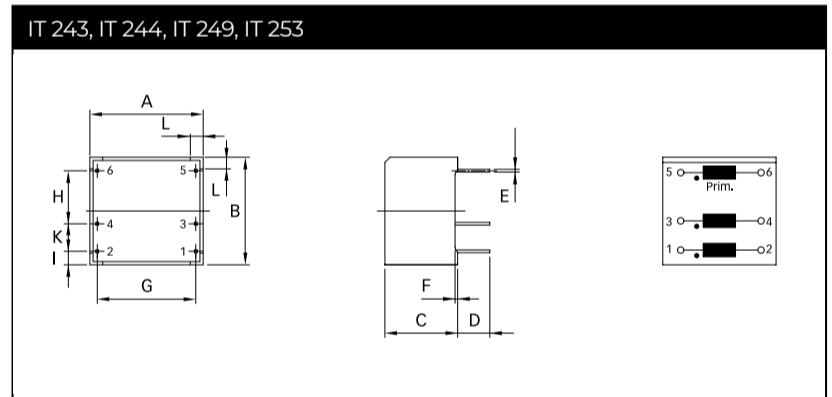
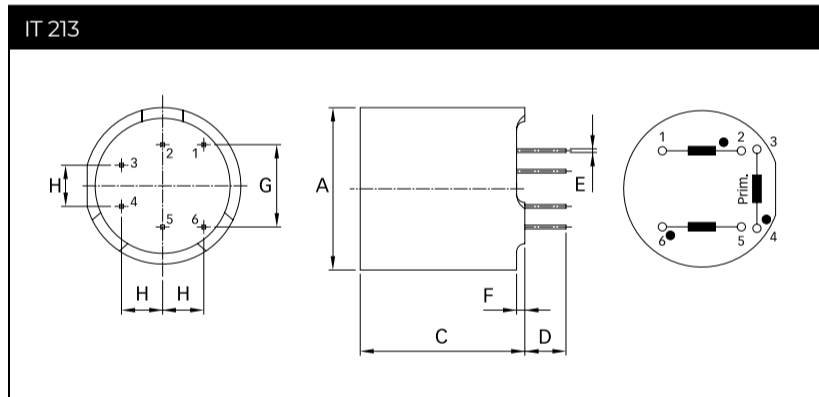

## IT 312, IT 313, IT 314

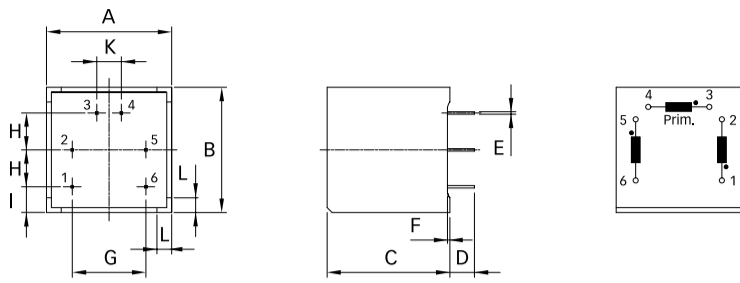

## Dimensions

	IT 213	IT 243	IT 244	IT 249	IT 253	IT 242	IT 143	IT 154	IT 233	IT 234	IT 312	IT 313	IT 314	Tol.
<b>A</b>	Ø19	17.6	17.6	17.6	17.6	17.6	27*	27*	27*	27*	25.5*	25.5*	25.5*	±0.1
<b>B</b>		16.7	16.7	16.7	16.7	16.7	22.5*	22.5*	22.5*	22.5*	25.5*	25.5*	25.5*	±0.1
<b>C</b>	20	11.3	11.3	11.3	11.3	11.3	13.7	13.7	13.7	13.7	25*	25*	25*	±0.1
<b>D</b>	5	5	5	5	5	5	5	5	5	5	5	5	5	+1/-0
<b>E</b>	0.45	0.42	0.42	0.42	0.42	0.42	0.45	0.45	0.45	0.45	0.5	0.5	0.5	
<b>F</b>	1	0.4	0.4	0.4	0.4	0.4	0.7	0.7	0.7	0.7	0.5	0.5	0.5	
<b>G</b>	10	15.3	15.3	15.3	15.3	15.3	20	20	20	20	15	15	15	
<b>H</b>	5	7.5	7.5	7.5	7.5	7.5	7.5	7.5	7.5	7.5	7.5	7.5	7.5	±0.2
<b>I</b>		2.1	2.1	2.1	2.1	2.1	3.75	3.75	3.75	3.75	5.25	5.25	5.25	±0.2
<b>K</b>		5	5	5	5	5					5	5	5	±0.2
<b>L</b>		2	2	2	2	2	2.5	2.5	2.5	2.5	3	3	3	

\* Tolerance is ±0.2

All dimensions in mm; 1 inch = 25.4 mm

Tolerances according: ISO 2768-m/EN 22768-m

Please visit [www.schaffner.com](http://www.schaffner.com) to find more details on filter connectors.

## Headquarters, Global Innovation and Development

### Switzerland

#### Schaffner Holding AG

Industrie Nord  
Nordstrasse 11e  
4542  
Luterbach  
+41 32 681 66 26  
[info@schaffner.com](mailto:info@schaffner.com)

## Sales and Application Centers

### China

#### Schaffner EMC Ltd. Shanghai

T20-3 C, No 565 Chuangye Road, Pudong district  
201201  
Shanghai  
+86 2138139500  
[cschina@schaffner.com](mailto:cschina@schaffner.com)

### Finland

#### Schaffner Oy

Sauvonrinne 19 H  
8500  
Lohja  
+358 50 468 7284  
[finlandsales@schaffner.com](mailto:finlandsales@schaffner.com)

### France

#### Schaffner EMC S.A.S.

16-20 Rue Louis Rameau  
95875  
Bezons  
+33 1 34 34 30 60  
[francesales@schaffner.com](mailto:francesales@schaffner.com)

### Germany

#### Schaffner Deutschland GmbH

Schoemperlenstrasse 12B  
76185  
Karlsruhe  
+49 721 56910  
[germanysales@schaffner.com](mailto:germanysales@schaffner.com)

### India

#### Schaffner India Pvt. Ltd

Regus World Trade Centre  
WTC, 22nd Floor Unit No 2238, Brigade Gateway Campus, 26/1, Dr. Rajkumar Road Malleshwaram (W)  
560055  
Bangalore  
+91 8067935355  
[indiasales@schaffner.com](mailto:indiasales@schaffner.com)

### Italy

#### Schaffner EMC S.r.l.

Via Ticino, 30  
20900  
Monza (MB)  
+39 039 21 41 070  
[italysales@schaffner.com](mailto:italysales@schaffner.com)

### Japan

#### Schaffner EMC K.K.

ISM Sangenjaya 7F  
1-32-12 Kamiuma, Setagaya-ku  
154-0011  
Tokyo  
+81 3 5712 3650  
[japansales@schaffner.com](mailto:japansales@schaffner.com)

### Singapore

#### Schaffner EMC Pte Ltd.

Blk 3015A Ubi Road 1, #05-09, Kampong Ubi Industrial Estate  
408705  
Singapore  
+65 63773283  
[singaporesales@schaffner.com](mailto:singaporesales@schaffner.com)

### Spain

#### Schaffner EMC España

Calle Caléndula 93, Miniparc III, Edificio E El Soto de Moraleja, Alcobendas  
28109  
Madrid  
+34 917 912 900  
[spainsales@schaffner.com](mailto:spainsales@schaffner.com)

### Sweden

#### Schaffner EMC AB

Östermalmstrorg 1  
114 42  
Stockholm  
+46 8 5050 2425  
[swedensales@schaffner.com](mailto:swedensales@schaffner.com)

### Switzerland

#### Schaffner EMV AG

Industrie Nord  
Nordstrasse 11e  
4542  
Luterbach  
+41 32 681 66 26  
[switzerlandsales@schaffner.com](mailto:switzerlandsales@schaffner.com)

### Taiwan

#### Schaffner EMV Ltd.

U-Town  
20 Floor-2, No 97, Section 1, XinTai 5th Road, XiZhi District  
22175  
New Taipei City  
+886 226975500  
[taiwansales@schaffner.com](mailto:taiwansales@schaffner.com)

### Thailand

#### Schaffner EMC Co. Ltd.

Sathorn Square Tower  
Room 3780, 37FL, 98 North-Sathorn Rd, Silom, Bangrak  
10500  
Bangkok  
+66 621056397  
[thailandsales@schaffner.com](mailto:thailandsales@schaffner.com)

### United Kingdom

#### Schaffner Ltd.

1, Oakmede Place  
Terrace Road  
RG42 4JF  
Binfield  
+44 118 9770070  
[uksales@schaffner.com](mailto:uksales@schaffner.com)

### United States

#### Schaffner EMC Inc.

52 Mayfield Avenue  
Edison, New Jersey  
+1 732 225 9533  
[usasales@schaffner.com](mailto:usasales@schaffner.com)

To find your local partner within Schaffner's global network [schaffner.com](http://schaffner.com)

© 2022 Schaffner Group

The content of this document has been carefully checked and understood. However, neither Schaffner nor its subsidiaries assume any liability whatsoever for any errors or inaccuracies of this document and the consequences thereof. Published specifications are subject to change without notice. Product suitability for any area of application must ultimately be determined by the customer. In all cases, products must never be operated outside their published specifications. Schaffner does not guarantee the availability of all published products. This disclaimer shall be governed by substantive Swiss law and resulting disputes shall be settled by the courts at the place of business of Schaffner Holding AG. Latest publications and a complete disclaimer can be downloaded from the Schaffner website. All trademarks recognized.

## Looking for pricing, stock, or lifecycle information?

Click below to explore more details on WIN SOURCE:

- [View IT244 on WIN SOURCE](#)
- [Schaffner EMC Inc. Information](#)

## Optimize Your Supply Chain with WIN SOURCE Solutions

- ✓ Global Sourcing Solution
- ✓ Obsolete Management
- ✓ Cost Control Management
- ✓ Shortage Management
- ✓ Alternative Solution
- ✓ Excess Inventory Management