



**THE DATASHEET OF  
XXHCCCNANF-25.000000**



# XX Type

## 3.2 x 2.5 mm SMD Crystal

### FEATURE

- Conforms to AEC-Q200
- Typical 3.2 x 2.5 x 0.75 mm ultra thin ceramic package.
- 8mm width Tape & Reel package for automatic assembly.
- Tight tolerance 10 ppm available.

### TYPICAL APPLICATION

- Automotive
- Bluetooth, Mobile Phone, GPS
- Wireless LAN, 4G/LTE
- Hard Disk

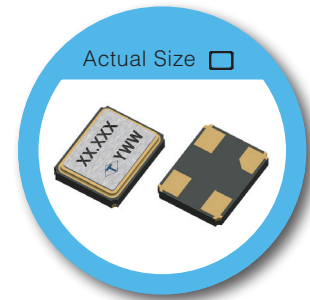

RoHS Compliant

### DIMENSION (mm)

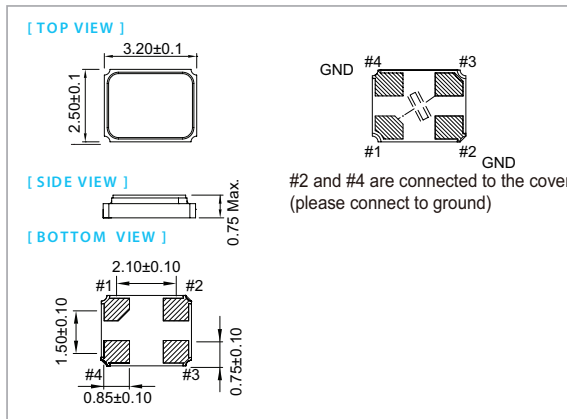

### SOLDER PAD LAYOUT (mm)

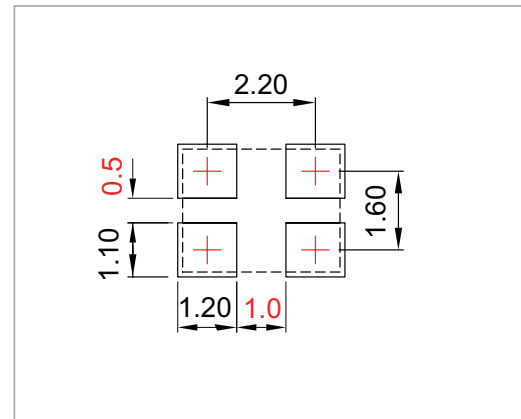

### ELECTRICAL SPECIFICATION

Parameter	Min.	Typical	Max.	Unit
Storage Temp. Range	-55	-	125	°C
Standard Frequency	16, 24, 26, 27, 32, 40			MHz
Level of Drive	-	10	200	µw
Shunt Capacitance (Co)	-	-	3.0	pF
Insulation Resistance	500 MΩ @ DC100V	-	-	
Aging	±1.0 to ±3.0			ppm / year

Standard frequencies are frequencies which the crystal has been designed and does not imply a stock position.

### EQUIVALENT SERIES RESISTANCE (E. S. R.)

Frequency Range	MODE	E.S.R
8 MHz ≤ Fo < 10 MHz	A1	<400 Ω
10 MHz ≤ Fo ≤ 13 MHz	A1	<150 Ω
13 MHz < Fo ≤ 19.5 MHz	A1	<80 Ω
19.5 MHz < Fo ≤ 27 MHz	A1	<60 Ω
27 MHz < Fo ≤ 60 MHz	A1	<50 Ω

### FREQ. STABILITY vs. TEMP. RANGE

Temp. (°C)	ppm		
	±5	±10	±15
-10 ~ +60	△	○	○
-20 ~ +70	X	○	○
-40 ~ +85	X	X	△

\* ○: Available △:Conditional X: Not available

### FREQ. STABILITY vs. WIDE TEMP. RANGE

Temp. (°C)	ppm			
	±15	±20	±30	±50
-40 ~ +105	△	○	○	○
-40 ~ +125	X	X	△	○

\* ○: Available △:Conditional X: Not available

**Note: not all combination of options are available. Other specifications may be available upon request.**







## Looking for pricing, stock, or lifecycle information?

Click below to explore more details on WIN SOURCE:

 [View XXHCCCNANF-25.000000 on WIN SOURCE](#)

 [Taitien](#) Information

## Optimize Your Supply Chain with WIN SOURCE Solutions

-  Global Sourcing Solution
-  Obsolete Management
-  Cost Control Management
-  Shortage Management
-  Alternative Solution
-  Excess Inventory Management