



THE DATASHEET OF PCMF3USB3SZ



PCMFxUSB3S series

Common-mode EMI filter for differential channels with integrated ESD protection

Rev. 3 — 7 March 2019

Product data sheet

1. General description

Common-mode ElectroMagnetic Interference (EMI) filters with integrated ElectroStatic Discharge (ESD) protection for one, two and three differential channels. The devices are designed to provide low insertion loss for differential high-speed signals on each channel while unwanted common-mode signals are attenuated.

Each differential channel incorporates two signal lines that are coupled by integrated coils. Diodes provide protection to downstream components from ESD voltages up to ± 15 kV on each signal line.

Table 1. Product overview

Type number	Number of channels	Package Name
PCMF1USB3S	1	WLCSP5
PCMF2USB3S	2	WLCSP10
PCMF3USB3S	3	WLCSP15

2. Features and benefits

- One, two and three differential channels common-mode EMI filters with integrated ESD protection
- ESD protection up to ± 15 kV contact discharge according to IEC 61000-4-2
- Superior common-mode suppression over a wide frequency range
- Superior RF performance compared to other integrated filters or discrete filters with external ESD protection
- Extremely high symmetry between line pairs
- Industry-standard Wafer-Level Chip-Scale Packages: WLCSP5, 10 and 15 for smaller footprint

3. Applications

- Smartphone, cellular and cordless phone
- Tablet PC and Mobile Internet Device (MID)
- USB 3.2, USB 2.0, HDMI 2.0, HDMI 1.4
- MIPI M-PHY and D-PHY as used in Camera Serial Interface (CSI) and Display Serial Interface (DSI)
- General-purpose EMI and Radio-Frequency Interference (RFI) filter and downstream ESD protection

4. Pinning information

Table 2. Pinning

Pin	Symbol	Description	Simplified outline	Graphic symbol
PCMF1USB3S (WLCSP5_2-1-2)				
A1	CH1_IN+	channel 1+, external	<p>Transparent top view WLCSP5_2-1-2</p>	<p>aaa-019784</p>
A2	CH1_IN-	channel 1-, external		
B1	GND_CH1	ground channel 1		
C1	CH1_OUT+	channel 1+, internal		
C2	CH1_OUT-	channel 1-, internal		
PCMF2USB3S (WLCSP10_4-2-4)				
A1	CH1_IN+	channel 1+, external	<p>Transparent top view WLCSP10_4-2-4</p>	<p>B1, B2 - no internal connection aaa-019785</p>
A2	CH1_IN-	channel 1-, external		
A3	CH2_IN+	channel 2+, external		
A4	CH2_IN-	channel 2-, external		
B1	GND_CH1	ground channel 1		
B2	GND_CH2	ground channel 2		
C1	CH1_OUT+	channel 1+, internal		
C2	CH1_OUT-	channel 1-, internal		
C3	CH2_OUT+	channel 2+, internal		
C4	CH2_OUT-	channel 2-, internal		
PCMF3USB3S (WLCSP15_6-3-6)				
A1	CH1_IN+	channel 1+, external	<p>Transparent top view WLCSP15_6-3-6</p>	<p>B1, B2, B3 - no internal connection aaa-019786</p>
A2	CH1_IN-	channel 1-, external		
A3	CH2_IN+	channel 2+, external		
A4	CH2_IN-	channel 2-, external		
A5	CH3_IN+	channel 3+, external		
A6	CH3_IN-	channel 3-, external		
B1	GND_CH1	ground channel 1		
B2	GND_CH2	ground channel 2		
B3	GND_CH3	ground channel 3		
C1	CH1_OUT+	channel 1+, internal		
C2	CH1_OUT-	channel 1-, internal		
C3	CH2_OUT+	channel 2+, internal		
C4	CH2_OUT-	channel 2-, internal		
C5	CH3_OUT+	channel 3+, internal		
C6	CH3_OUT-	channel 3-, internal		

5. Ordering information

Table 3. Ordering information

Type number	Package	
	Name	Description
PCMF1USB3S	WLCSP5	wafer level chip-size package; 5 bumps (2-1-2)
PCMF2USB3S	WLCSP10	wafer level chip-size package; 10 bumps (4-2-4)
PCMF3USB3S	WLCSP15	wafer level chip-size package; 15 bumps (6-3-6)

6. Marking

Table 4. Marking codes

Type number	Marking code
PCMF1USB3S	PF1S
PCMF2USB3S	PF2S
PCMF3USB3S	PF3S

7. Limiting values

Table 5. Limiting values

In accordance with the Absolute Maximum Rating System (IEC 60134).

Symbol	Parameter	Conditions	Min	Max	Unit
V_I	input voltage		-0.5	5	V
V_{ESD}	electrostatic discharge voltage	IEC 61000-4-2, level 4; all input pins to ground			
		contact discharge	-15	15	kV
		air discharge	-15	15	kV
		IEC 61000-4-2, level 4; all output pins to ground			
		contact discharge	-2	2	kV
		air discharge	-2	2	kV
I_{PPM}	rated peak-pulse current	$t_p = 8/20 \mu s$	-7	7	A
T_{stg}	storage temperature		-40	125	°C
T_{amb}	ambient temperature		-40	125	°C

8. Characteristics

8.1. Channel characteristics

Table 6. Channel characteristics

$T_{amb} = 25\text{ °C}$ unless otherwise specified.

Symbol	Parameter	Conditions	Min	Typ	Max	Unit
$R_{s(ch)}$	channel series resistance	single line; input to output	-	3	-	Ω
C_d	diode capacitance	$f = 1\text{ MHz}$; $V_I = 2.5\text{ V}$	[1]	0.25	-	pF
I_{RM}	reverse leakage current	per line; $V_I = 5\text{ V}$	-	-	100	nA
V_{BR}	breakdown voltage	$I_R = 1\text{ mA}$	6	9	-	V
V_F	forward voltage	$I_F = 10\text{ mA}$	-	0.8	-	V
R_{dyn}	dynamic resistance	TLP; positive transient	[2]	0.14	-	Ω
		TLP; negative transient	[2]	0.14	-	Ω
		surge; positive transient	[3]	0.22	-	Ω
		surge; negative transient	[3]	0.22	-	Ω

[1] This parameter is guaranteed by design.

[2] 100 ns Transmission Line Pulse (TLP); 50 Ω ; pulser at 70 ns to 90 ns.

[3] According to IEC 61000-4-5 (8/20 μ s).

8.2. Frequency characteristics

Table 7. Frequency characteristics

$T_{amb} = 25\text{ °C}$ unless otherwise specified.

Symbol	Parameter	Conditions	Min	Typ	Max	Unit
Common mode: S_{21cc}						
α_{il}	insertion loss	$f = 800\text{ MHz}$	[1]	-12	-	dB
		$f = 2.6\text{ GHz}$	[1]	-38	-	dB
		$f = 5\text{ GHz}$	[1]	-18	-	dB
Differential mode: S_{21dd}						
α_{il}	insertion loss	$f = 1\text{ MHz}$	[1]	0.3	-	dB
f_{-3dB}	cut-off frequency		[1]	6	-	GHz

[1] Normalized to attenuation at 1 MHz.

Common-mode EMI filter for differential channels with integrated ESD protection

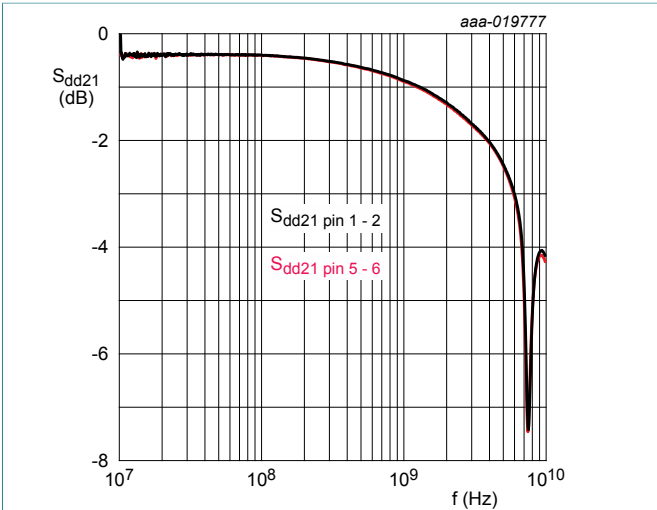

Fig. 1. Differential-mode insertion loss; typical values

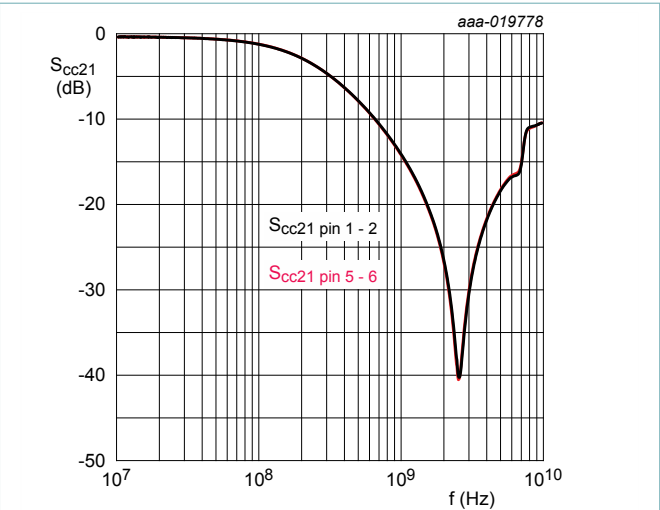

Fig. 2. Common-mode insertion loss; typical values

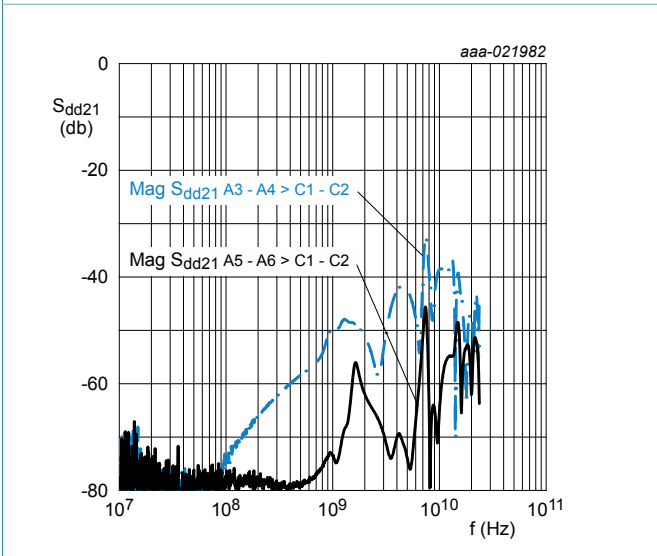

Fig. 3. Differential crosstalk; typical values

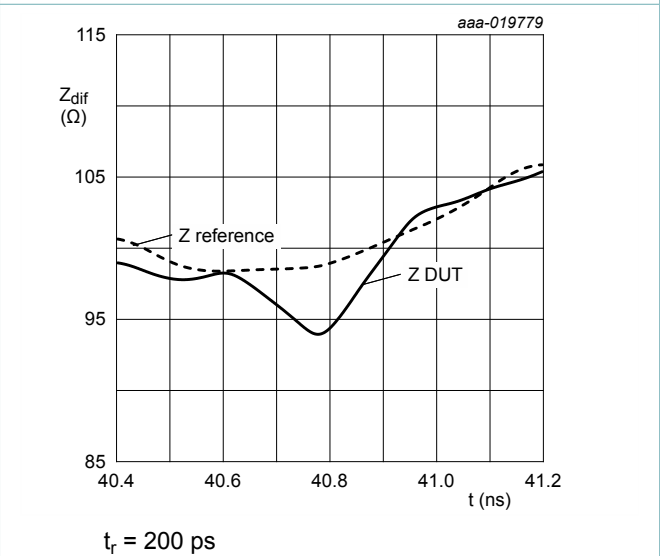
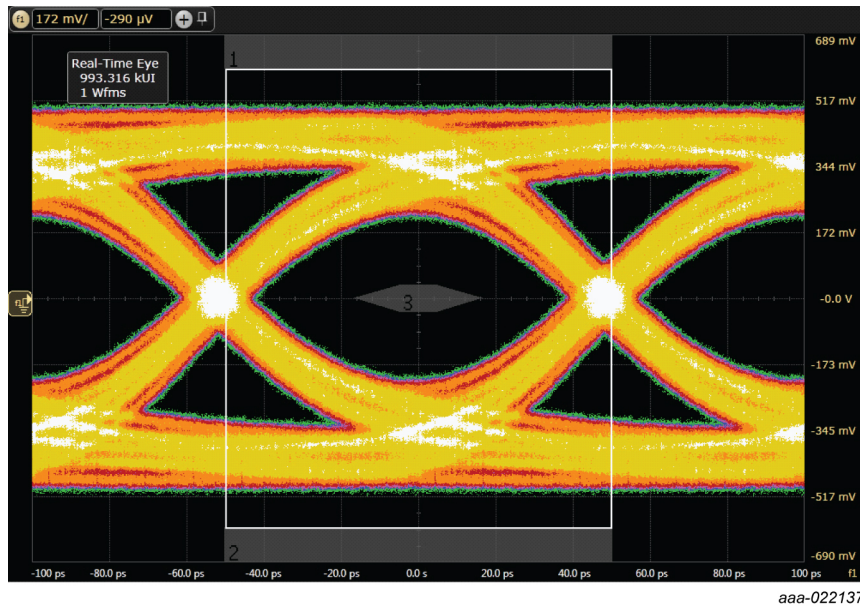

Fig. 4. Differential Time Domain Reflectometer (TDR) plot; typical values

Common-mode EMI filter for differential channels with integrated ESD protection



Data rate: 10 Gbit/s
 Vertical scale 172 mV/div
 Horizontal scale: 20 ps/div

Fig. 5. USB 3.2 eye diagram 10 Gbps, test board with PCMF2USB3S; typical values

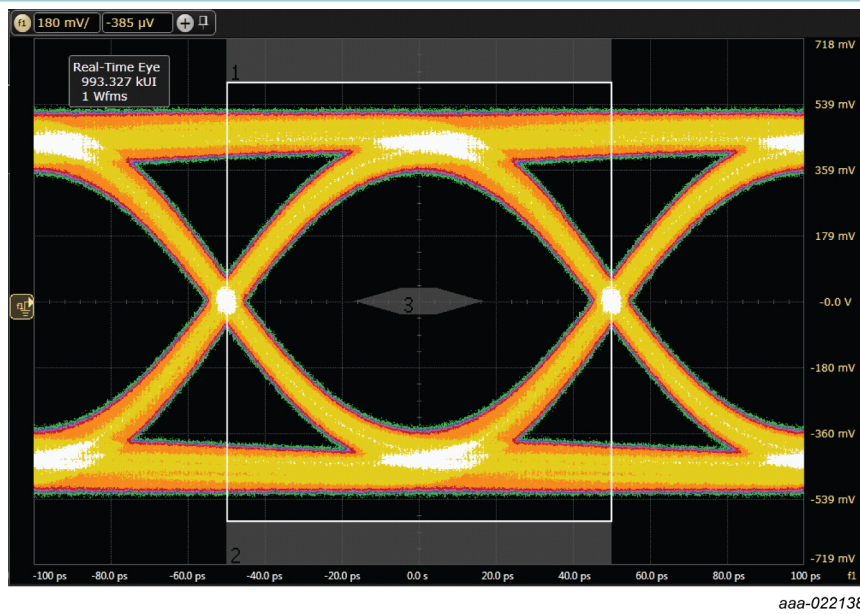

Data rate: 10 Gbit/s
 Vertical scale 180 mV/div
 Horizontal scale: 20 ps/div

Fig. 6. USB 3.2 eye diagram 10 Gbps, test board without device; typical values

Common-mode EMI filter for differential channels with integrated ESD protection

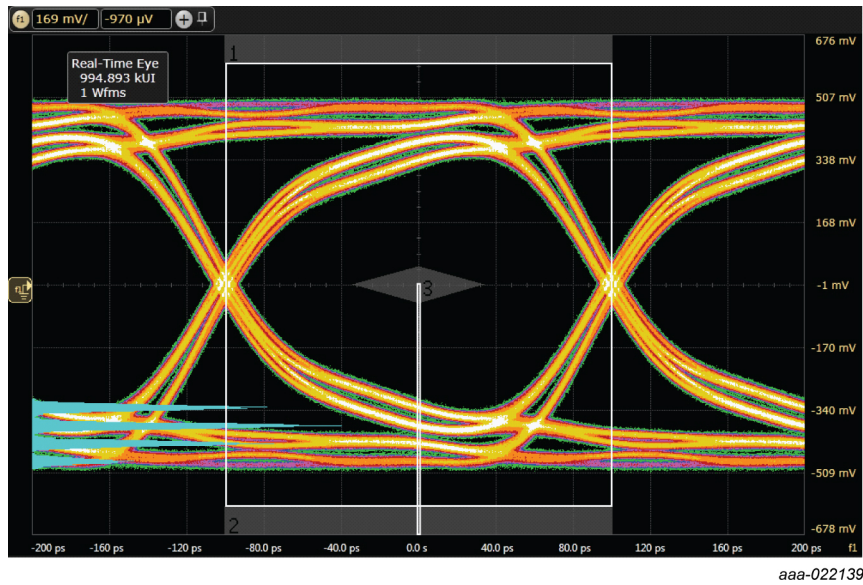

Data rate: 5 Gbit/s
 Vertical scale 169 mV/div
 Horizontal scale: 40 ps/div

Fig. 7. USB 3.2 eye diagram 5 Gbps, test board with PCMF2USB3S; typical values

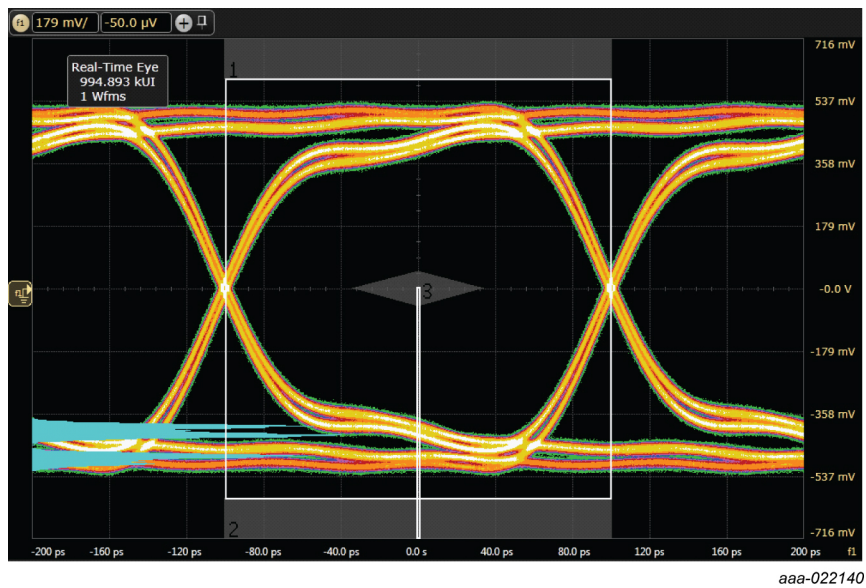

Data rate: 5 Gbit/s
 Vertical scale 179 mV/div
 Horizontal scale: 40 ps/div

Fig. 8. USB 3.2 eye diagram 5 Gbps, test board without device; typical values

Common-mode EMI filter for differential channels with integrated ESD protection

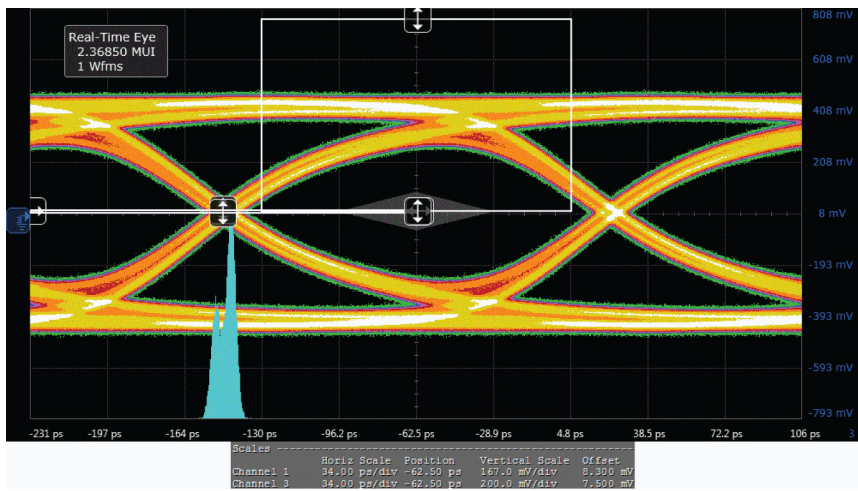

aaa-022141

Test frequency: 148.5 MHz
 Differential swing voltage: 861 mV
 Horizontal scale: 34 ps/div

Fig. 9. HDMI 2.0 eye diagram TP1, test board with PCMF2USB3S; typical values

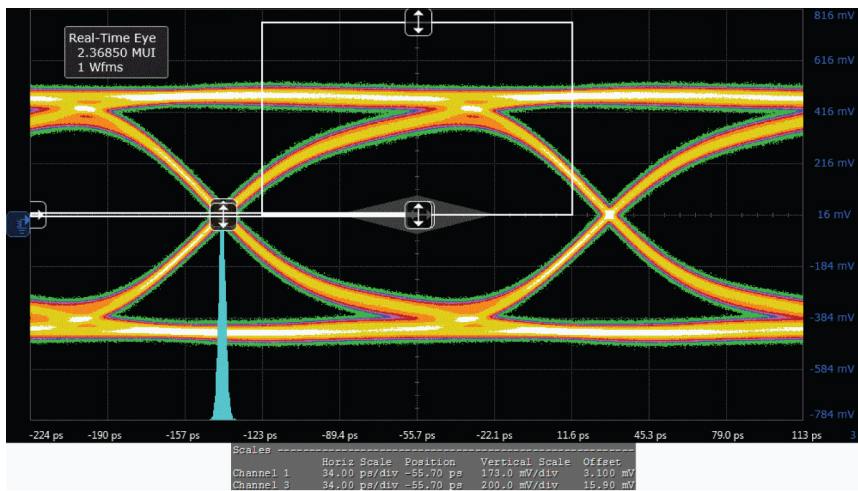

aaa-022142

Test frequency: 148.5 MHz
 Differential swing voltage: 917 mV
 Horizontal scale: 34 ps/div

Fig. 10. HDMI 2.0 eye diagram TP1, test board without device; typical values

Common-mode EMI filter for differential channels with integrated ESD protection

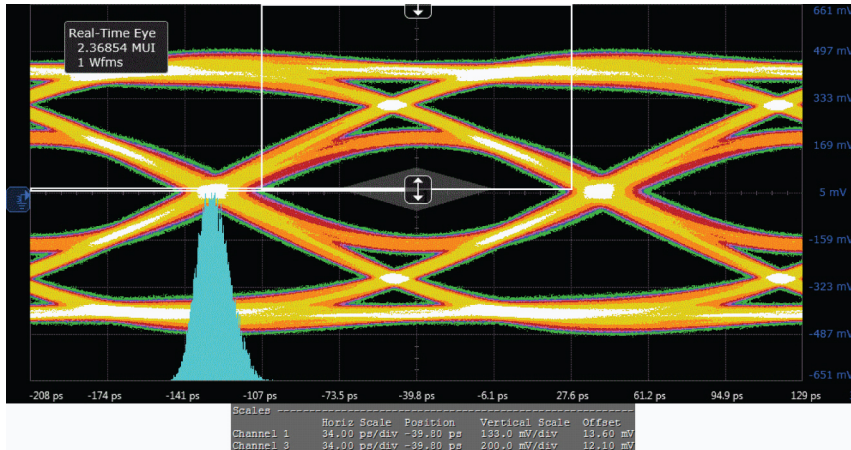

aaa-022143

Test frequency: 148.5 MHz

Differential swing voltage: 849 mV

Horizontal scale: 34 ps/div

Remark: Measured at Test Point 2 (TP2) worst cable emulator, reference cable equalizer and worst case positive skew.

Fig. 11. HDMI 2.0 eye diagram TP2, test board with PCMF2USB3S; typical values

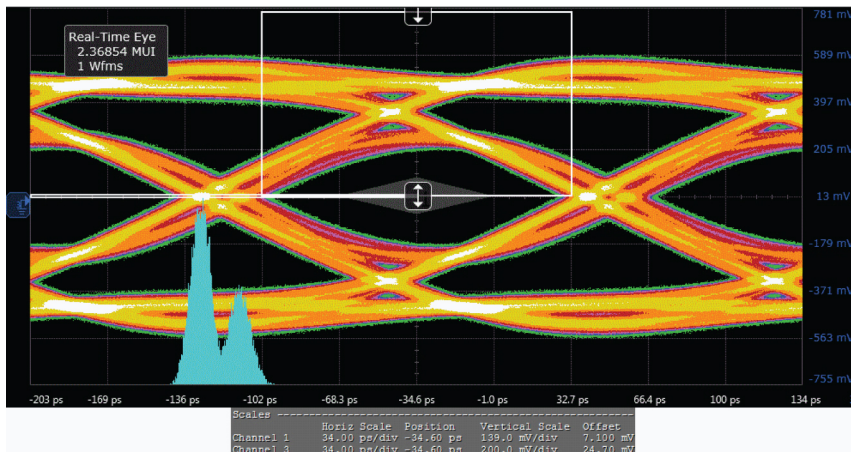

aaa-022144

Test frequency: 148.5 MHz

Differential swing voltage: 909 mV

Horizontal scale: 34 ps/div

Remark: Measured at Test Point 2 (TP2) worst cable emulator, reference cable equalizer and worst case positive skew.

Fig. 12. HDMI 2.0 eye diagram TP2, test board without device; typical values

Common-mode EMI filter for differential channels with integrated ESD protection

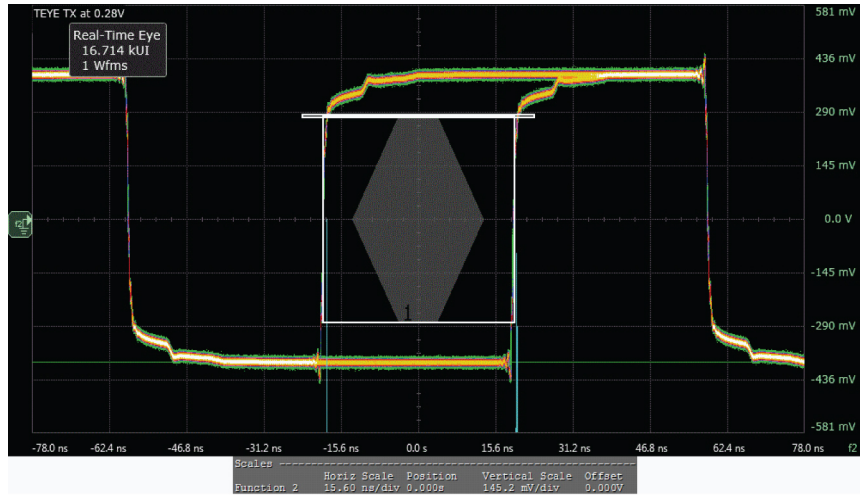

aaa-022146

Vertical scale: 145 mV/div
Horizontal scale: 15.6 ns/div

Fig. 13. MIPI M-PHY PWM-TX transmitter eye opening at 140 mV, test board with PCMF2USB3S; typical value

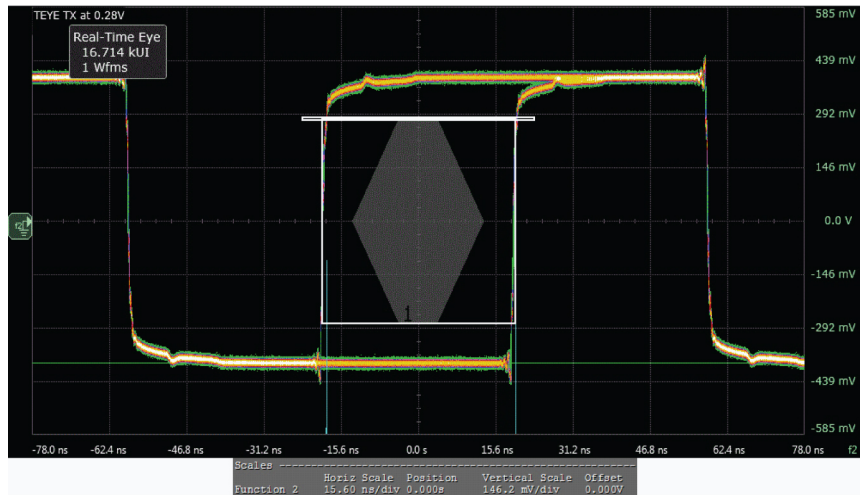

aaa-022148

Vertical scale: 146 mV/div
Horizontal scale: 15.6 ns/div

Fig. 14. MIPI M-PHY PWM-TX transmitter eye opening at 140 mV, test board without device; typical value

Common-mode EMI filter for differential channels with integrated ESD protection

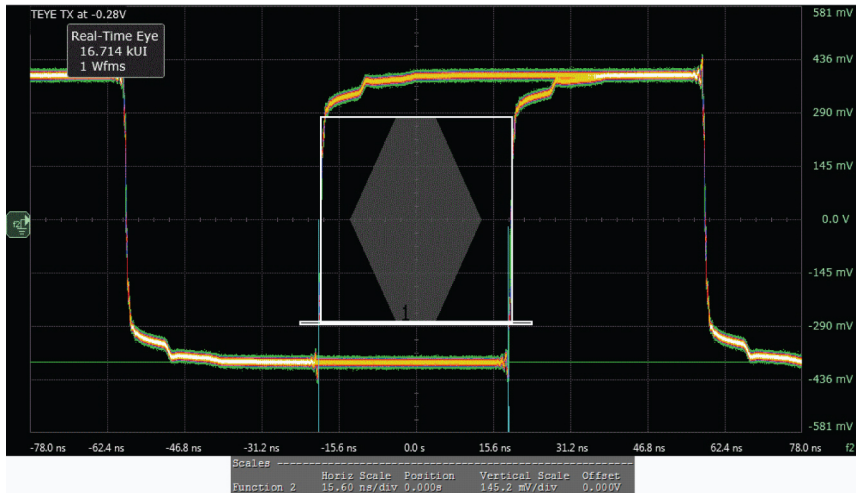

aaa-022147

Vertical scale: 145 mV/div
Horizontal scale: 15.6 ns/div

Fig. 15. MIPI M-PHY PWM-TX transmitter eye opening at -140 mV, test board with PCMF2USB3S; typical value

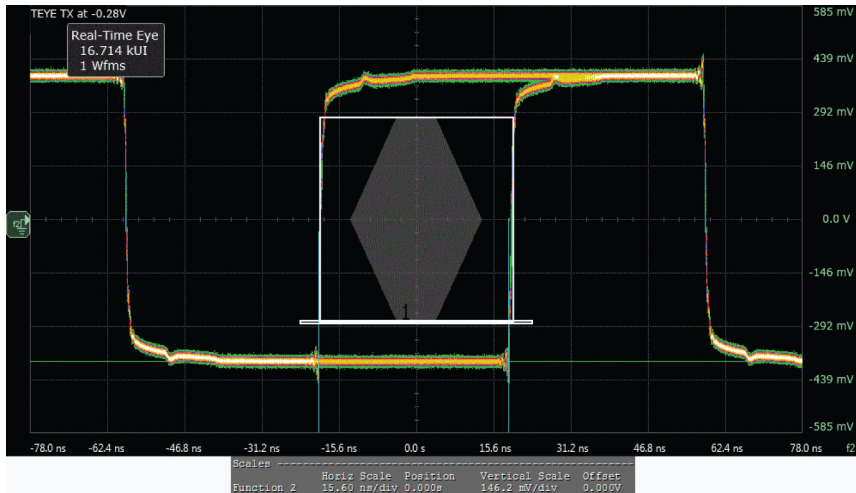

aaa-022149

Vertical scale: 145 mV/div
Horizontal scale: 15.6 ns/div

Fig. 16. MIPI M-PHY PWM-TX transmitter eye opening at -140 mV, test board without device; typical value

Common-mode EMI filter for differential channels with integrated ESD protection

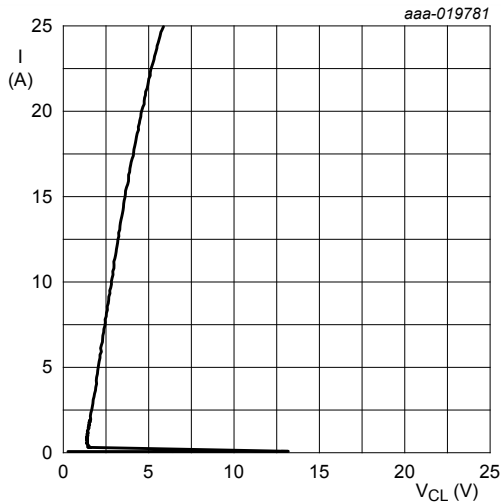

Transmission Line Pulse (TLP) = 100 ns;
 $t_r = 1$ ns

Fig. 17. Dynamic resistance with positive clamping; typical values

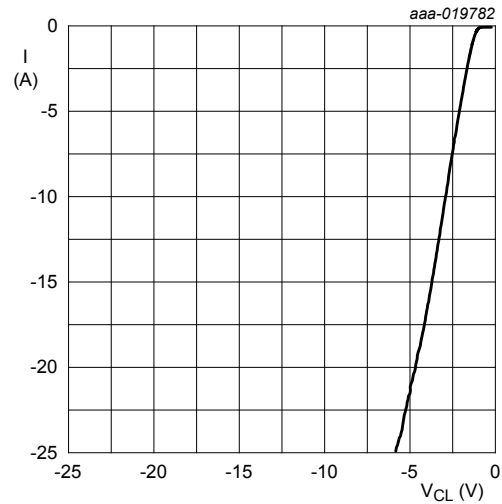

Transmission Line Pulse (TLP) = 100 ns;
 $t_r = 1$ ns

Fig. 18. Dynamic resistance with negative clamping; typical values

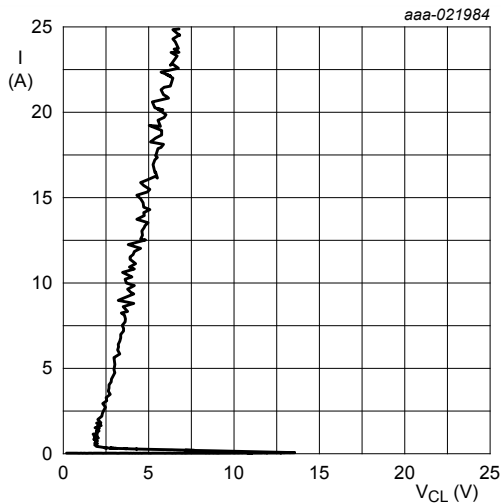

Very-Fast Transmission Line Pulse
 (VF-TLP) = 5 ns;
 $t_r = 600$ ps

Fig. 19. Dynamic resistance with positive clamping; typical values

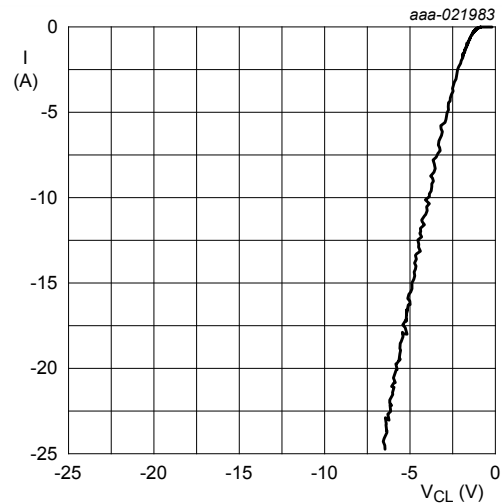

Very-Fast Transmission Line Pulse
 (VF-TLP) = 5 ns;
 $t_r = 600$ ps

Fig. 20. Dynamic resistance with negative clamping; typical values

The device uses an advanced clamping structure showing a negative dynamic resistance. This snap-back behavior strongly reduces the clamping voltage to the system behind the ESD protection during an ESD event. Do not connect unlimited DC current sources to the data lines to avoid keeping the ESD protection device in snap-back state after exceeding breakdown voltage (due to an ESD pulse for instance).

Common-mode EMI filter for differential channels with integrated ESD protection

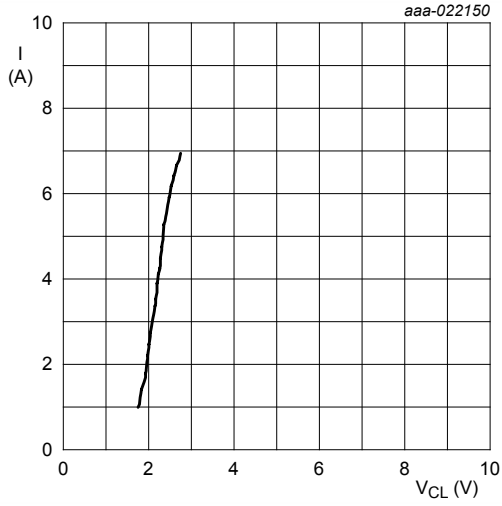

IEC61000-4-5; $t_p = 8/20 \mu s$; positive pulse

Fig. 21. Dynamic resistance with positive clamping; typical values

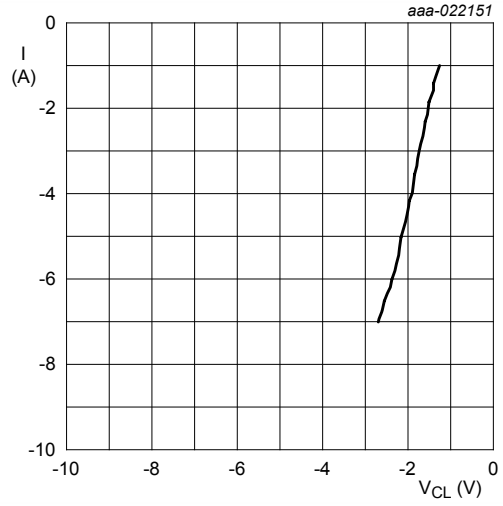

IEC61000-4-5; $t_p = 8/20 \mu s$; negative pulse

Fig. 22. Dynamic resistance with negative clamping; typical values

9. Application information

The device is designed to provide high-level ESD protection for differential high-speed data line pairs such as:

- USB 3.2
- HDMI 2.0
- Transition-Minimized Differential Signaling (TMDS)
- DisplayPort
- external Serial Advanced Technology Attachment (eSATA)
- Low Voltage Differential Signaling (LVDS)

When designing the Printed-Circuit Board (PCB), give careful consideration to impedance matching and signal coupling. Do not connect the protected signal lines to unlimited current sources like, for example, a battery.

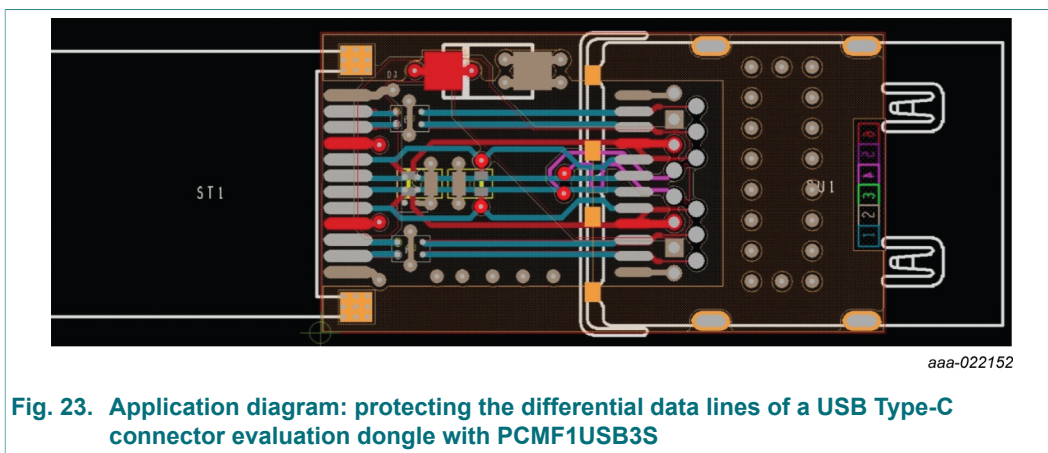

Fig. 23. Application diagram: protecting the differential data lines of a USB Type-C connector evaluation dongle with PCMF1USB3S

Since the SuperSpeed TX/RX lines are separated by GND or VBUS from the Hi-Speed lines, PCMF1USB3S makes it easy to achieve same signal lengths, straight routing, and optimal positioning for ESD protection directly at the connector.

10. Package outline

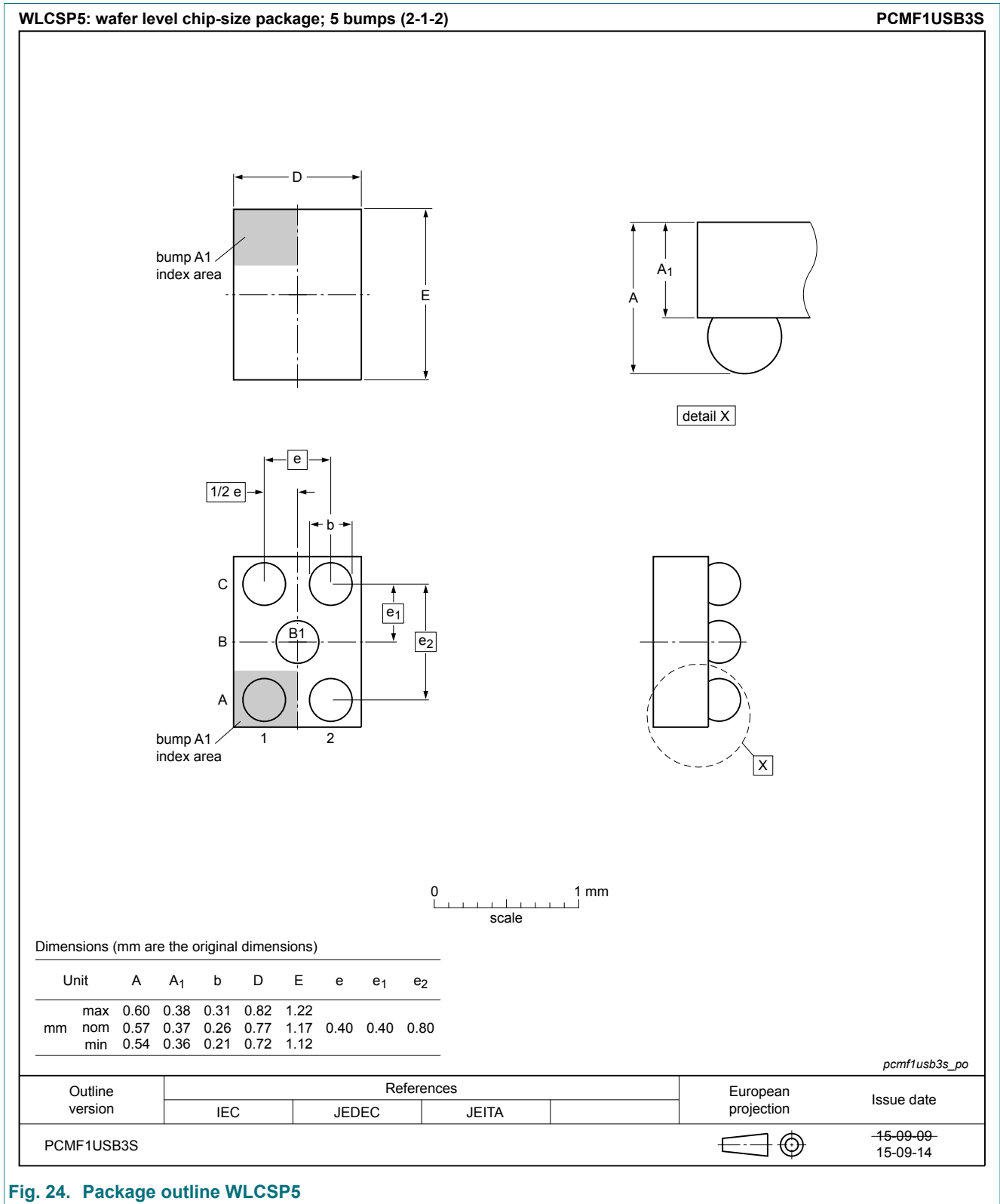
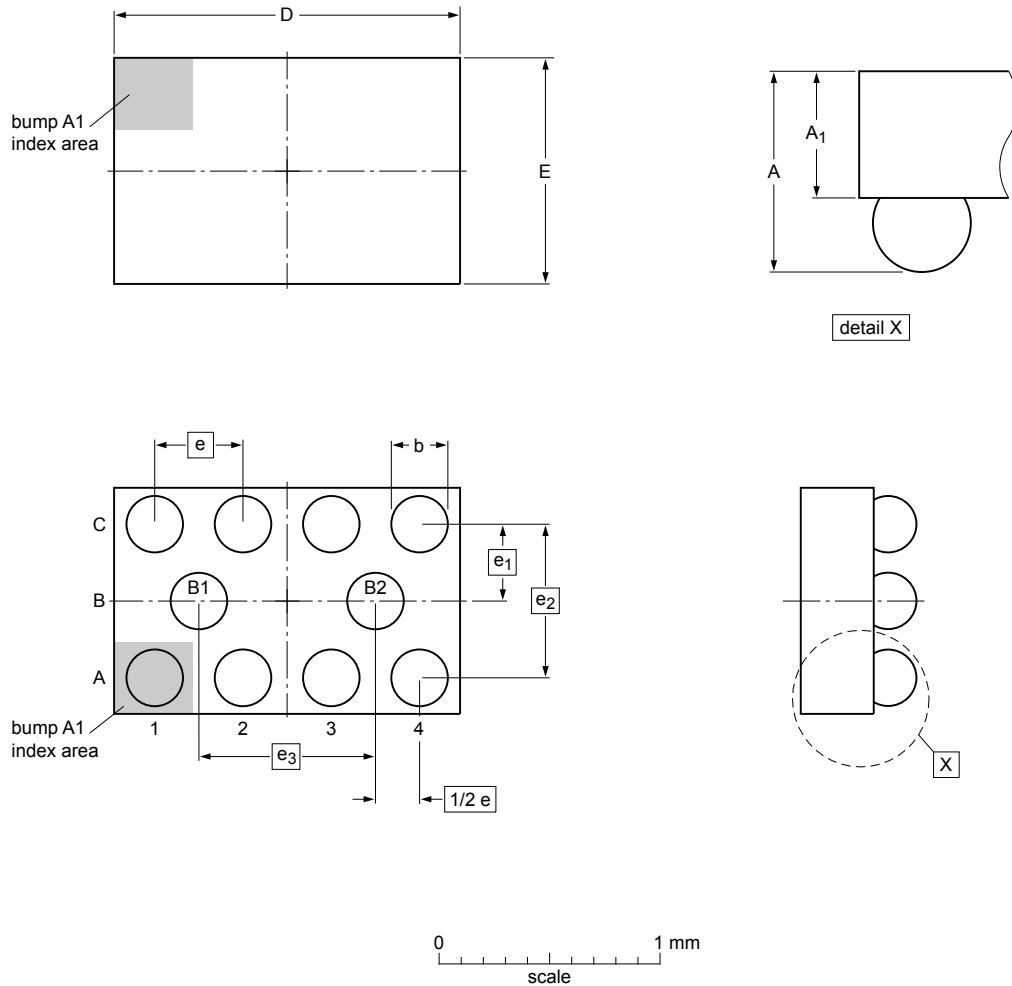

Fig. 24. Package outline WLCSP5

WLCSP10: wafer level chip-size package; 10 bumps (4-2-4)

PCMF2USB3S



Dimensions (mm are the original dimensions)

Unit	A	A ₁	b	D	E	e	e ₁	e ₂	e ₃
mm	max 0.60	0.38	0.31	1.62	1.22				
	nom 0.57	0.37	0.26	1.57	1.17	0.40	0.40	0.80	0.80
	min 0.54	0.36	0.21	1.52	1.12				

pcmf2usb3s_po

Outline version	References				European projection	Issue date
	IEC	JEDEC	JEITA			
PCMF2USB3S						15-09-09 15-09-14

Fig. 25. Package outline WLCSP10

WLCSP15: wafer level chip-size package; 15 bumps (6-3-6)

PCMF3USB3S

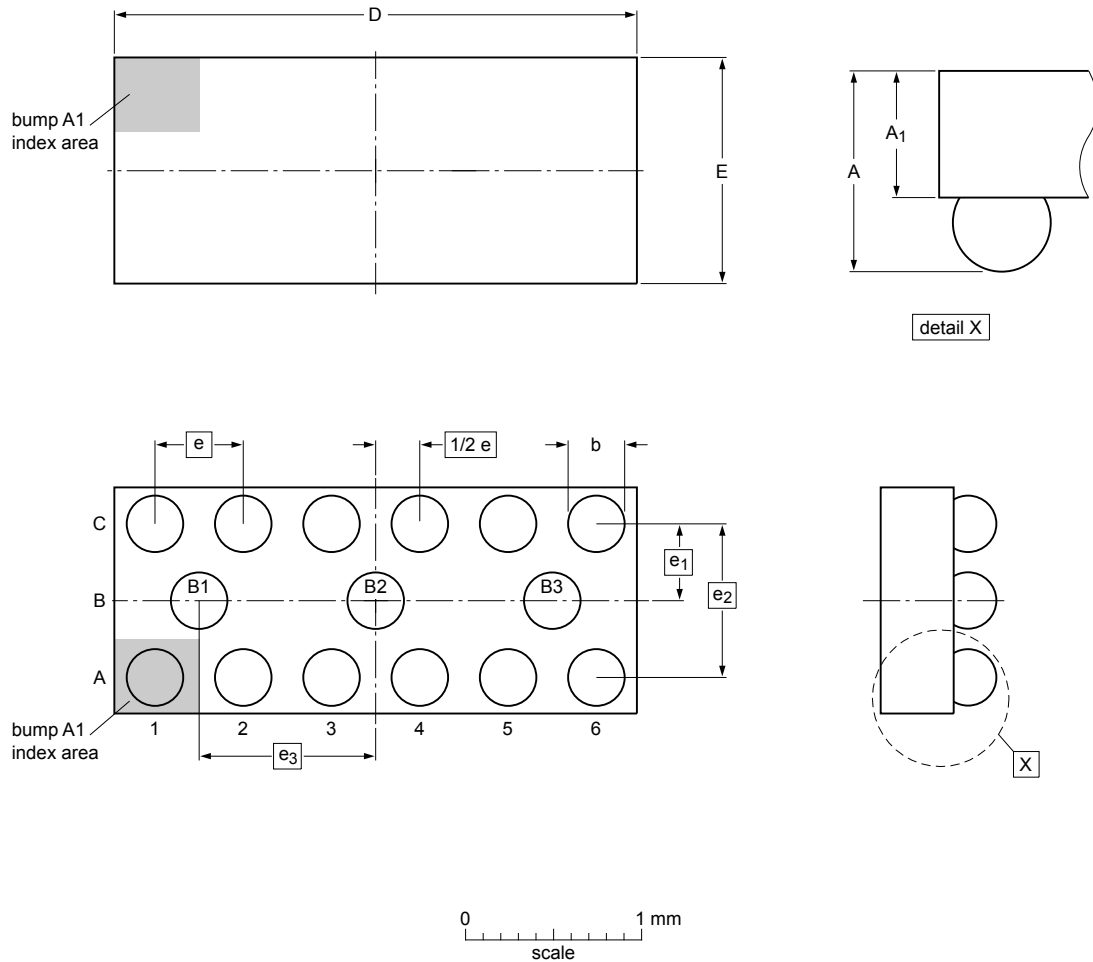

Dimensions (mm are the original dimensions)

Unit	A	A ₁	b	D	E	e	e ₁	e ₂	e ₃
mm	max 0.60	0.38	0.31	2.42	1.22				
	nom 0.57	0.37	0.26	2.37	1.17	0.40	0.40	0.80	0.80
	min 0.54	0.36	0.21	2.32	1.12				

pcmf3usb3s_po

Outline version	References			European projection	Issue date
	IEC	JEDEC	JEITA		
PCMF3USB3S					15-09-09 15-09-14

Fig. 26. Package outline WLCSP15

11. Soldering

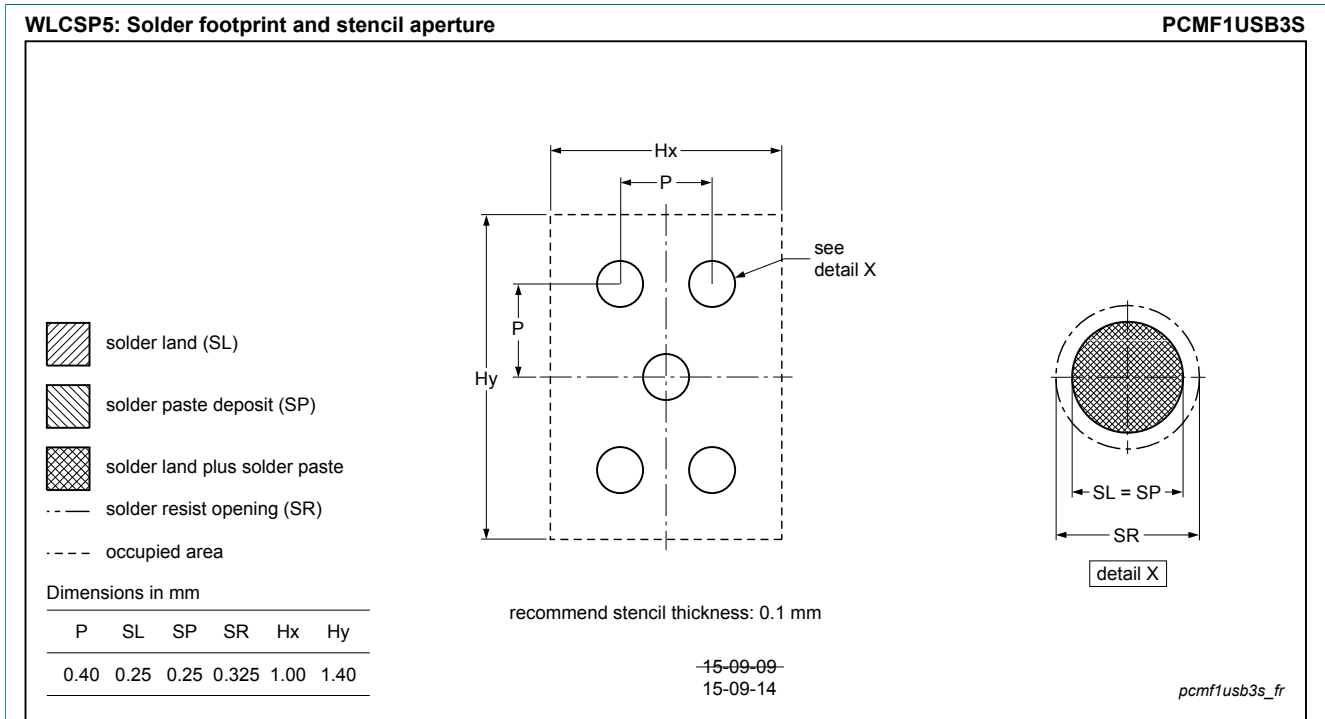

Fig. 27. Soldering footprint WLCSP5 (PCMF1USB3S)

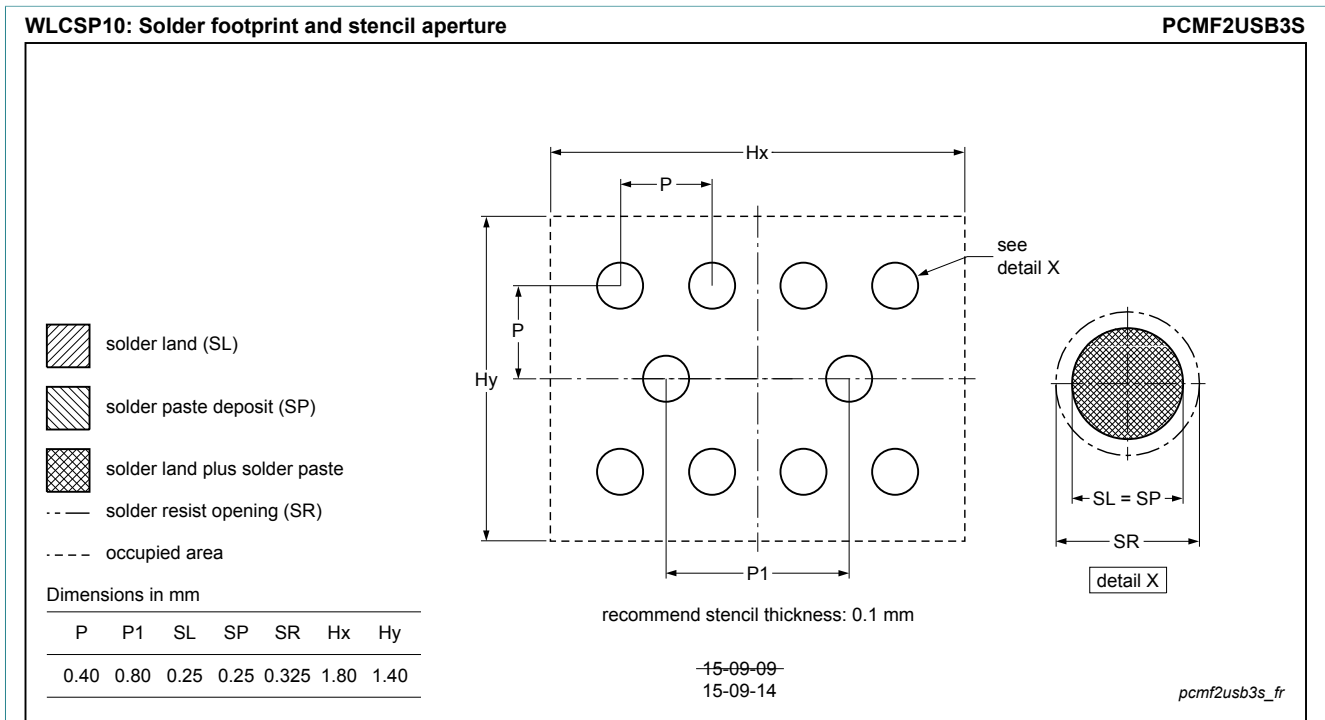

Fig. 28. Soldering footprint WLCSP10 (PCMF2USB3S)

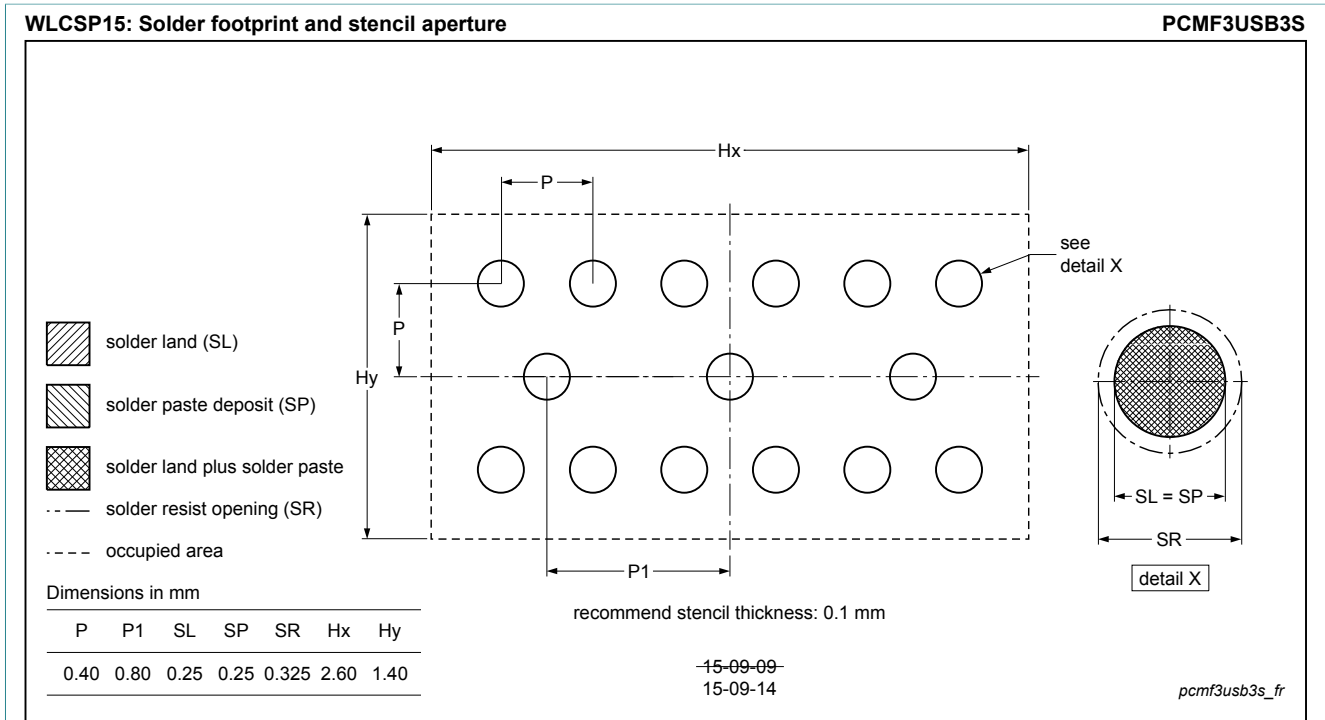

Fig. 29. Soldering footprint WLCSP15 (PCMF3USB3S)

12. Revision history

Table 8. Revision history

Data sheet ID	Release date	Data sheet status	Change notice	Supersedes
PCMFxUSB3S_SER v.3	20190307	Product data sheet	-	PCMFxUSB3S_SER v.2
Modifications:	<ul style="list-style-type: none"> Limiting values: T_{amb} maximum values updated. Frequency characteristics: corrected typos in Figures 1, 2, 3 and 5. 			
PCMFxUSB3S_SER v.2	20160307	Product data sheet	-	PCMFxUSB3S_SER v.1
PCMFxUSB3S_SER v.1	20151007	Preliminary data sheet	-	-

13. Legal information

Data sheet status

Document status [1][2]	Product status [3]	Definition
Objective [short] data sheet	Development	This document contains data from the objective specification for product development.
Preliminary [short] data sheet	Qualification	This document contains data from the preliminary specification.
Product [short] data sheet	Production	This document contains the product specification.

- [1] Please consult the most recently issued document before initiating or completing a design.
- [2] The term 'short data sheet' is explained in section "Definitions".
- [3] The product status of device(s) described in this document may have changed since this document was published and may differ in case of multiple devices. The latest product status information is available on the internet at <https://www.nexperia.com>.

Definitions

Draft — The document is a draft version only. The content is still under internal review and subject to formal approval, which may result in modifications or additions. Nexperia does not give any representations or warranties as to the accuracy or completeness of information included herein and shall have no liability for the consequences of use of such information.

Short data sheet — A short data sheet is an extract from a full data sheet with the same product type number(s) and title. A short data sheet is intended for quick reference only and should not be relied upon to contain detailed and full information. For detailed and full information see the relevant full data sheet, which is available on request via the local Nexperia sales office. In case of any inconsistency or conflict with the short data sheet, the full data sheet shall prevail.

Product specification — The information and data provided in a Product data sheet shall define the specification of the product as agreed between Nexperia and its customer, unless Nexperia and customer have explicitly agreed otherwise in writing. In no event however, shall an agreement be valid in which the Nexperia product is deemed to offer functions and qualities beyond those described in the Product data sheet.

Disclaimers

Limited warranty and liability — Information in this document is believed to be accurate and reliable. However, Nexperia does not give any representations or warranties, expressed or implied, as to the accuracy or completeness of such information and shall have no liability for the consequences of use of such information. Nexperia takes no responsibility for the content in this document if provided by an information source outside of Nexperia.

In no event shall Nexperia be liable for any indirect, incidental, punitive, special or consequential damages (including - without limitation - lost profits, lost savings, business interruption, costs related to the removal or replacement of any products or rework charges) whether or not such damages are based on tort (including negligence), warranty, breach of contract or any other legal theory.

Notwithstanding any damages that customer might incur for any reason whatsoever, Nexperia's aggregate and cumulative liability towards customer for the products described herein shall be limited in accordance with the Terms and conditions of commercial sale of Nexperia.

Right to make changes — Nexperia reserves the right to make changes to information published in this document, including without limitation specifications and product descriptions, at any time and without notice. This document supersedes and replaces all information supplied prior to the publication hereof.

Suitability for use — Nexperia products are not designed, authorized or warranted to be suitable for use in life support, life-critical or safety-critical systems or equipment, nor in applications where failure or malfunction of an Nexperia product can reasonably be expected to result in personal

injury, death or severe property or environmental damage. Nexperia and its suppliers accept no liability for inclusion and/or use of Nexperia products in such equipment or applications and therefore such inclusion and/or use is at the customer's own risk.

Quick reference data — The Quick reference data is an extract of the product data given in the Limiting values and Characteristics sections of this document, and as such is not complete, exhaustive or legally binding.

Applications — Applications that are described herein for any of these products are for illustrative purposes only. Nexperia makes no representation or warranty that such applications will be suitable for the specified use without further testing or modification.

Customers are responsible for the design and operation of their applications and products using Nexperia products, and Nexperia accepts no liability for any assistance with applications or customer product design. It is customer's sole responsibility to determine whether the Nexperia product is suitable and fit for the customer's applications and products planned, as well as for the planned application and use of customer's third party customer(s). Customers should provide appropriate design and operating safeguards to minimize the risks associated with their applications and products.

Nexperia does not accept any liability related to any default, damage, costs or problem which is based on any weakness or default in the customer's applications or products, or the application or use by customer's third party customer(s). Customer is responsible for doing all necessary testing for the customer's applications and products using Nexperia products in order to avoid a default of the applications and the products or of the application or use by customer's third party customer(s). Nexperia does not accept any liability in this respect.

Limiting values — Stress above one or more limiting values (as defined in the Absolute Maximum Ratings System of IEC 60134) will cause permanent damage to the device. Limiting values are stress ratings only and (proper) operation of the device at these or any other conditions above those given in the Recommended operating conditions section (if present) or the Characteristics sections of this document is not warranted. Constant or repeated exposure to limiting values will permanently and irreversibly affect the quality and reliability of the device.

Terms and conditions of commercial sale — Nexperia products are sold subject to the general terms and conditions of commercial sale, as published at <http://www.nexperia.com/profile/terms>, unless otherwise agreed in a valid written individual agreement. In case an individual agreement is concluded only the terms and conditions of the respective agreement shall apply. Nexperia hereby expressly objects to applying the customer's general terms and conditions with regard to the purchase of Nexperia products by customer.

No offer to sell or license — Nothing in this document may be interpreted or construed as an offer to sell products that is open for acceptance or the grant, conveyance or implication of any license under any copyrights, patents or other industrial or intellectual property rights.

Export control — This document as well as the item(s) described herein may be subject to export control regulations. Export might require a prior authorization from competent authorities.

Non-automotive qualified products — Unless this data sheet expressly states that this specific Nexperia product is automotive qualified, the product is not suitable for automotive use. It is neither qualified nor tested in accordance with automotive testing or application requirements. Nexperia accepts no liability for inclusion and/or use of non-automotive qualified products in automotive equipment or applications.

In the event that customer uses the product for design-in and use in automotive applications to automotive specifications and standards, customer (a) shall use the product without Nexperia's warranty of the product for such automotive applications, use and specifications, and (b) whenever customer uses the product for automotive applications beyond Nexperia's specifications such use shall be solely at customer's own risk, and (c) customer fully indemnifies Nexperia for any liability, damages or failed product claims resulting from customer design and use of the product for automotive applications beyond Nexperia's standard warranty and Nexperia's product specifications.

Translations — A non-English (translated) version of a document is for reference only. The English version shall prevail in case of any discrepancy between the translated and English versions.

Trademarks

Notice: All referenced brands, product names, service names and trademarks are the property of their respective owners.

Contents

1. General description	1
2. Features and benefits	1
3. Applications	1
4. Pinning information	2
5. Ordering information	3
6. Marking	3
7. Limiting values	3
8. Characteristics	4
8.1. Channel characteristics.....	4
8.2. Frequency characteristics.....	4
9. Application information	14
10. Package outline	15
11. Soldering	18
12. Revision history	20
13. Legal information	21

© Nexperia B.V. 2019. All rights reserved



For more information, please visit: <http://www.nexperia.com>

For sales office addresses, please send an email to: salesaddresses@nexperia.com

Date of release: 7 March 2019

Looking for pricing, stock, or lifecycle information?

Click below to explore more details on WIN SOURCE:

-  [View PCMF3USB3SZ on WIN SOURCE](#)
-  [Nexperia USA Inc. Information](#)

Optimize Your Supply Chain with WIN SOURCE Solutions

-  Global Sourcing Solution
-  Obsolete Management
-  Cost Control Management
-  Shortage Management
-  Alternative Solution
-  Excess Inventory Management