



**THE DATASHEET OF
LQW2UASR27J00L**



CHIP COILS (CHIP INDUCTORS) LQW2UAS□□□□00 REFERENCE SPECIFICATION

1. Scope

This reference specification applies to chip coils (chip inductors) LQW2UAS_00 series for general electronic equipment.

2. Part Numbering

(Ex.)

LQ	W	2U	A	S	12N	G	0	0	L
Product ID	Structure	Dimension (L × W)	Application and characteristic	Category	Inductance	Tolerance	Performance	Electrode specification	Packaging L: taping *B: bulk

*B: Bulk packing is also available (taping condition: however, products without reels are put in plastic bags).

3. Part Number and Rating

Operating temperature range	-55°C to +125°C
Storage temperature range	-55°C to +125°C

Customer Part number	Murata Part number	Inductance		Q (Min.)	DC resistance (Ω max.)	Self-resonant frequency (MHz min.)	Rated current (mA)
		Nominal value (nH)	Tolerance				
	LQW2UAS12NG00L	12	G: ±2%	50	0.09	3300	1000
	LQW2UAS12NJ00L	12	J: ±5%	50	0.09	3300	1000
	LQW2UAS18NG00L	18	G: ±2%	50	0.11	2500	1000
	LQW2UAS18NJ00L	18	J: ±5%	50	0.11	2500	1000
	LQW2UAS22NF00L	22	F: ±1%	55	0.12	2400	1000
	LQW2UAS22NG00L	22	G: ±2%	55	0.12	2400	1000
	LQW2UAS22NJ00L	22	J: ±5%	55	0.12	2400	1000
	LQW2UAS27NG00L	27	G: ±2%	55	0.13	1600	1000
	LQW2UAS27NJ00L	27	J: ±5%	55	0.13	1600	1000
	LQW2UAS33NF00L	33	F: ±1%	60	0.14	1600	1000
	LQW2UAS33NG00L	33	G: ±2%	60	0.14	1600	1000
	LQW2UAS33NJ00L	33	J: ±5%	60	0.14	1600	1000
	LQW2UAS39NF00L	39	F: ±1%	60	0.15	1500	1000
	LQW2UAS39NG00L	39	G: ±2%	60	0.15	1500	1000
	LQW2UAS39NJ00L	39	J: ±5%	60	0.15	1500	1000
	LQW2UAS47NF00L	47	F: ±1%	65	0.16	1500	1000
	LQW2UAS47NG00L	47	G: ±2%	65	0.16	1500	1000
	LQW2UAS47NJ00L	47	J: ±5%	65	0.16	1500	1000
	LQW2UAS56NF00L	56	F: ±1%	65	0.18	1300	1000
	LQW2UAS56NG00L	56	G: ±2%	65	0.18	1300	1000
	LQW2UAS56NJ00L	56	J: ±5%	65	0.18	1300	1000
	LQW2UAS68NF00L	68	F: ±1%	65	0.20	1300	1000
	LQW2UAS68NG00L	68	G: ±2%	65	0.20	1300	1000
	LQW2UAS68NJ00L	68	J: ±5%	65	0.20	1300	1000
	LQW2UAS82NF00L	82	F: ±1%	60	0.22	1000	1000
	LQW2UAS82NG00L	82	G: ±2%	60	0.22	1000	1000
	LQW2UAS82NJ00L	82	J: ±5%	60	0.22	1000	1000
	LQW2UASR10F00L	100	F: ±1%	60	0.56	1000	650
	LQW2UASR10G00L	100	G: ±2%	60	0.56	1000	650
	LQW2UASR10J00L	100	J: ±5%	60	0.56	1000	650

Customer Part number	Murata Part number	Inductance		Q (Min.)	DC resistance (Ω max.)	Self-resonant frequency (MHz min.)	Rated current (mA)
		Nominal value (nH)	Tolerance				
	LQW2UASR12F00L	120	F: $\pm 1\%$	60	0.63	950	650
	LQW2UASR12G00L	120	G: $\pm 2\%$	60	0.63	950	650
	LQW2UASR12J00L	120	J: $\pm 5\%$	60	0.63	950	650
	LQW2UASR15F00L	150	F: $\pm 1\%$	45	0.70	850	580
	LQW2UASR15G00L	150	G: $\pm 2\%$	45	0.70	850	580
	LQW2UASR15J00L	150	J: $\pm 5\%$	45	0.70	850	580
	LQW2UASR18F00L	180	F: $\pm 1\%$	45	0.77	750	620
	LQW2UASR18G00L	180	G: $\pm 2\%$	45	0.77	750	620
	LQW2UASR18J00L	180	J: $\pm 5\%$	45	0.77	750	620
	LQW2UASR22F00L	220	F: $\pm 1\%$	45	0.84	700	500
	LQW2UASR22G00L	220	G: $\pm 2\%$	45	0.84	700	500
	LQW2UASR22J00L	220	J: $\pm 5\%$	45	0.84	700	500
	LQW2UASR27F00L	270	F: $\pm 1\%$	45	0.91	600	500
	LQW2UASR27G00L	270	G: $\pm 2\%$	45	0.91	600	500
	LQW2UASR27J00L	270	J: $\pm 5\%$	45	0.91	600	500
	LQW2UASR33F00L	330	F: $\pm 1\%$	45	1.05	570	450
	LQW2UASR33G00L	330	G: $\pm 2\%$	45	1.05	570	450
	LQW2UASR33J00L	330	J: $\pm 5\%$	45	1.05	570	450
	LQW2UASR39F00L	390	F: $\pm 1\%$	45	1.12	500	470
	LQW2UASR39G00L	390	G: $\pm 2\%$	45	1.12	500	470
	LQW2UASR39J00L	390	J: $\pm 5\%$	45	1.12	500	470
	LQW2UASR47F00L	470	F: $\pm 1\%$	45	1.19	450	470
	LQW2UASR47G00L	470	G: $\pm 2\%$	45	1.19	450	470
	LQW2UASR47J00L	470	J: $\pm 5\%$	45	1.19	450	470
	LQW2UASR56F00L	560	F: $\pm 1\%$	45	1.33	415	400
	LQW2UASR56G00L	560	G: $\pm 2\%$	45	1.33	415	400
	LQW2UASR56J00L	560	J: $\pm 5\%$	45	1.33	415	400
	LQW2UASR62F00L	620	F: $\pm 1\%$	45	1.40	375	300
	LQW2UASR62G00L	620	G: $\pm 2\%$	45	1.40	375	300
	LQW2UASR62J00L	620	J: $\pm 5\%$	45	1.40	375	300
	LQW2UASR68F00L	680	F: $\pm 1\%$	45	1.47	375	400
	LQW2UASR68G00L	680	G: $\pm 2\%$	45	1.47	375	400
	LQW2UASR68J00L	680	J: $\pm 5\%$	45	1.47	375	400
	LQW2UASR75F00L	750	F: $\pm 1\%$	45	1.54	360	360
	LQW2UASR75G00L	750	G: $\pm 2\%$	45	1.54	360	360
	LQW2UASR75J00L	750	J: $\pm 5\%$	45	1.54	360	360
	LQW2UASR82F00L	820	F: $\pm 1\%$	45	1.61	350	400
	LQW2UASR82G00L	820	G: $\pm 2\%$	45	1.61	350	400
	LQW2UASR82J00L	820	J: $\pm 5\%$	45	1.61	350	400
	LQW2UASR91F00L	910	F: $\pm 1\%$	35	1.68	320	380
	LQW2UASR91G00L	910	G: $\pm 2\%$	35	1.68	320	380
	LQW2UASR91J00L	910	J: $\pm 5\%$	35	1.68	320	380
	LQW2UAS1R0F00L	1000	F: $\pm 1\%$	35	1.75	290	370
	LQW2UAS1R0G00L	1000	G: $\pm 2\%$	35	1.75	290	370
	LQW2UAS1R0J00L	1000	J: $\pm 5\%$	35	1.75	290	370
	LQW2UAS1R2J00L	1200	J: $\pm 5\%$	35	2.0	210	310

Customer Part number	Murata Part number	Inductance		Q (Min.)	DC resistance (Ω max.)	Self-resonant frequency (MHz min.)	Rated current (mA)
		Nominal value (nH)	Tolerance				
	LQW2UAS1R5J00L	1500	J: $\pm 5\%$	28	2.3	120	330
	LQW2UAS1R8J00L	1800	J: $\pm 5\%$	28	2.6	140	300
	LQW2UAS2R2J00L	2200	J: $\pm 5\%$	28	2.8	130	280
	LQW2UAS2R7J00L	2700	J: $\pm 5\%$	22	3.2	110	290
	LQW2UAS3R3J00L	3300	J: $\pm 5\%$	22	3.4	90	290
	LQW2UAS3R9J00L	3900	J: $\pm 5\%$	20	3.6	70	260
	LQW2UAS4R7J00L	4700	J: $\pm 5\%$	20	4.0	60	260

4. Testing Conditions

Unless otherwise specified	Temperature: ordinary temperature (15°C to 35°C) Humidity: ordinary humidity [25% to 85% (RH)]
In case of doubt	Temperature: 20°C \pm 2°C Humidity: 60% to 70% (RH) Atmospheric pressure: 86 kPa to 106 kPa

5. Appearance and Dimensions

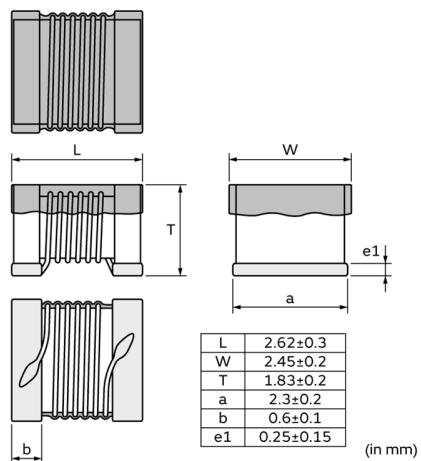

Unit mass (typical value): 0.039 g

6. Marking

No marking.

7. Electrical Performance

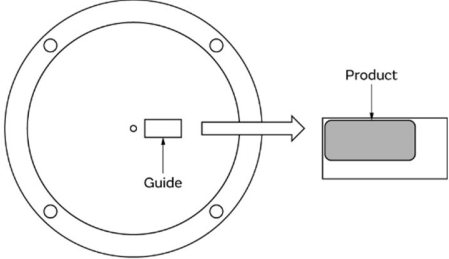
No.	Item	Specification	Test method																		
7.1	Inductance	Meet chapter 3 ratings.	<p>Measuring equipment: Keysight E4991A or the equivalent</p> <p>Measuring frequency:</p> <table border="1"> <tbody> <tr> <td rowspan="3">Inductance</td> <td>50 MHz</td> <td>12 nH to 82 nH</td> </tr> <tr> <td>25 MHz</td> <td>100 nH to 1000 nH</td> </tr> <tr> <td>7.9 MHz</td> <td>1200 nH to 4700 nH</td> </tr> <tr> <td rowspan="5">Q</td> <td>500 MHz</td> <td>12 nH to 15 nH</td> </tr> <tr> <td>350 MHz</td> <td>18 nH to 120 nH</td> </tr> <tr> <td>100 MHz</td> <td>150 nH to 820 nH</td> </tr> <tr> <td>50 MHz</td> <td>910 nH to 2200 nH</td> </tr> <tr> <td>25 MHz</td> <td>2700 nH to 4700 nH</td> </tr> </tbody> </table> <p>Measuring conditions: Measurement signal level: Approx. 0 dBm Measurement terminal distance: 1.5 mm Electrical length: 10.0 mm Weight: Approx. 1 N to 3 N Measuring fixture: Keysight 16197A Position the chip coil under test as shown in the measuring example below and connect it to the electrode by applying weight. Measurement example:</p>  <p>Measuring method: see "Electrical performance: Measuring method for inductance/Q" in the chapter "16. Appendix".</p>	Inductance	50 MHz	12 nH to 82 nH	25 MHz	100 nH to 1000 nH	7.9 MHz	1200 nH to 4700 nH	Q	500 MHz	12 nH to 15 nH	350 MHz	18 nH to 120 nH	100 MHz	150 nH to 820 nH	50 MHz	910 nH to 2200 nH	25 MHz	2700 nH to 4700 nH
Inductance	50 MHz	12 nH to 82 nH																			
	25 MHz	100 nH to 1000 nH																			
	7.9 MHz	1200 nH to 4700 nH																			
Q	500 MHz	12 nH to 15 nH																			
	350 MHz	18 nH to 120 nH																			
	100 MHz	150 nH to 820 nH																			
	50 MHz	910 nH to 2200 nH																			
	25 MHz	2700 nH to 4700 nH																			
7.2	Q	Meet chapter 3 ratings.	<p>Measuring method: see "Electrical performance: Measuring method for inductance/Q" in the chapter "16. Appendix".</p>																		
7.3	DC resistance	Meet chapter 3 ratings.	Measuring equipment: digital multimeter																		
7.4	Self-resonant frequency	Meet chapter 3 ratings.	Measuring equipment: Keysight N5230A or the equivalent																		
7.5	Rated current	Product temperature rise: 40°C max.	Apply the rated current specified in chapter 3.																		

8. Mechanical Performance

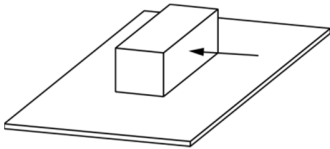
No.	Item	Specification	Test method
8.1	Shear test	No significant mechanical damage or no sign of electrode peeling off shall be observed.	<p>Test substrate: glass-epoxy substrate</p> <p>Force application direction:</p>  <p>Applying force: 10 N Holding time: 5 ±1 s</p>

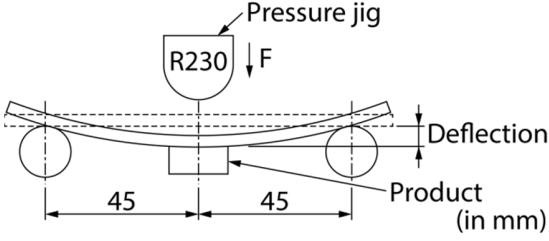
No.	Item	Specification	Test method
8.2	Bending test	No significant mechanical damage or no sign of electrode peeling off shall be observed.	<p>Test substrate: glass-epoxy substrate (100 mm × 40 mm × 1.0 mm) Pressurizing speed: 1 mm/s Deflection: 3 mm Holding time: 5 s</p> 
8.3	Vibration	Appearance shall have no significant mechanical damage.	<p>Oscillation frequency: 10 Hz to 2000 Hz to 10 Hz, for approx. 15 min Total amplitude: total amplitude of 3.0 mm or acceleration amplitude of 196 m/s², whichever is smaller Test time: 3 directions perpendicular to each other, 2 h for each direction (6 h in total)</p>
8.4	Solderability	90% or more of the outer electrode shall be covered with new solder seamlessly.	<p>Flux: immersed in ethanol solution [including an activator with a chlorine conversion value of 0.06(wt)%] with a rosin content of 25(wt)% for 5 s to 10 s. Solder: Sn-3.0Ag-0.5Cu solder Pre-heating: 150°C±10°C/60 s to 90 s Solder temperature: 240°C±5°C Immersion time: 3 s±1 s</p>
8.5	Resistance to soldering heat	Appearance: No significant mechanical damage shall be observed. Inductance change rate: within ±5%	<p>Flux: immersed in ethanol solution [including an activator with a chlorine conversion value of 0.06(wt)%] with a rosin content of 25(wt)% for 5 s to 10 s. Solder: Sn-3.0Ag-0.5Cu solder Pre-heating: 150°C±10°C/60 s to 90 s Solder temperature: 270°C±5°C Immersion time: 10 s±1 s Post-treatment: left at a room condition for 24 h±2 h</p>

9. Environmental Performance

The product is soldered on a substrate for test.

No.	Item	Specification	Test method
9.1	Heat resistance	Appearance: No significant mechanical damage shall be observed. Inductance change rate: within ±5% Q change rate: within ±20%	<p>Temperature: 125°C±2°C Test time: 1000 h (+48 h, -0 h) Post-treatment: left at a room condition for 24 h±2 h</p>
9.2	Cold resistance	Appearance: No significant mechanical damage shall be observed. Inductance change rate: within ±5% Q change rate: within ±20%	<p>Temperature: -55°C±2°C Test time: 1000 h (+48 h, -0 h) Post-treatment: left at a room condition for 24 h±2 h</p>
9.3	Humidity	Appearance: No significant mechanical damage shall be observed. Inductance change rate: within ±5% Q change rate: within ±20%	<p>Temperature: 85°C±2°C Humidity: 85% (RH) Test time: 1000 h (+48 h, -0 h) Post-treatment: left at a room condition for 24 h±2 h</p>
9.4	Temperature cycle	Appearance: No significant mechanical damage shall be observed. Inductance change rate: within ±5% Q change rate: within ±20%	<p>Single cycle conditions: Step 1: -55°C±2°C/30 min±3 min Step 2: ordinary temperature/10 min to 15 min Step 3: +125°C±2°C/30 min±3 min Step 4: ordinary temperature/10 min to 15 min Number of testing: 10 cycles Post-treatment: left at a room condition for 24 h±2 h</p>

10. Specification of Packaging

10.1 Appearance and dimensions of tape (8 mm width/plastic tape)



A	2.7±0.1
B	2.8±0.1
t	2.15±0.1
t'	0.25±0.05

(in mm)

* The dimensions of the cavity are measured at its bottom.

10.2 Taping specifications

Packing quantity (Standard quantity)	2000 pcs/reel
Packing method	The products are placed in embossed cavities of a plastic tape and sealed by a cover tape.
Feed hole position	The feed holes on the plastic tape are on the right side when the cover tape is pulled toward the user.
Joint	The plastic tape and the cover tape are seamless.
Number of missing products	Number of missing products within 0.025% of the number per reel or 1 pc., whichever is greater, and are not continuous. The specified quantity per reel is kept.

10.3 Break down force of tape

Break down force of cover tape	10 N min.
--------------------------------	-----------

10.4 Peeling off force of cover tape

Speed of peeling off	300 mm/min
Peeling off force	0.1 N to 0.6 N (The lower limit is for typical value.)

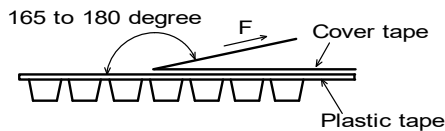

10.5 Dimensions of leader section, trailer section and reel

A vacant section is provided in the leader (start) section and trailer (end) section of the tape for the product. The leader section is further provided with an area consisting only of the cover tape (or top tape). (See the diagram below.)



(in mm)

10.6 Marking for reel

Customer part number, Murata part number, inspection number (*1), RoHS marking (*2), quantity, etc.

<p>*1 Expression of inspection No.:</p> <table style="width: 100%; border-collapse: collapse;"> <tr> <td style="text-align: center; border-bottom: 1px solid black;">□□</td> <td style="text-align: center; border-bottom: 1px solid black;">○○○○</td> <td style="text-align: center; border-bottom: 1px solid black;">◇◇◇</td> </tr> <tr> <td style="text-align: center;">(1)</td> <td style="text-align: center;">(2)</td> <td style="text-align: center;">(3)</td> </tr> </table>	□□	○○○○	◇◇◇	(1)	(2)	(3)	<p>(1) Factory code (2) Date First digit: year/last digit of year Second digit: month/Jan. to Sep.→1 to 9, Oct. to Dec.→O, N, D Third, Fourth digit: day (3) Serial No.</p>
□□	○○○○	◇◇◇					
(1)	(2)	(3)					
<p>*2 Expression of RoHS marking:</p> <table style="width: 100%; border-collapse: collapse;"> <tr> <td style="text-align: center;">ROHS-</td> <td style="text-align: center; border-bottom: 1px solid black;">Y</td> <td style="text-align: center; border-bottom: 1px solid black;">(△)</td> </tr> <tr> <td></td> <td style="text-align: center;">(1)</td> <td style="text-align: center;">(2)</td> </tr> </table>	ROHS-	Y	(△)		(1)	(2)	<p>(1) RoHS regulation conformity (2) Murata classification number</p>
ROHS-	Y	(△)					
	(1)	(2)					

10.7 Marking on outer box (corrugated box)

Customer name, purchasing order number, customer part number, Murata part number, RoHS marking (*2), quantity, etc.

10.8 Specification of outer box



Dimensions of outer box (mm)			Standard reel quantity in outer box (reel)
W	D	H	
186	186	93	5
* Above outer box size is typical. It depends on a quantity of an order.			

11. ⚠Caution

11.1 Restricted applications

Please contact us before using our products for the applications listed below which require especially high reliability for the prevention of defects which might directly cause damage to the third party's life, body or property.

- | | | | |
|-------------------------------|---|------------------------------|---|
| (1) Aircraft equipment | (2) Aerospace equipment | (3) Undersea equipment | (4) Power plant control equipment |
| (5) Medical equipment | (6) Transportation equipment (vehicles, trains, ships, etc.) | (7) Traffic signal equipment | (8) Disaster/crime prevention equipment |
| (9) Data-processing equipment | (10) Applications of similar complexity and/or reliability requirements to the applications listed in the above | | |

11.2 Precautions on rating

Avoid using in exceeded the rated temperature range, rated voltage, or rated current. Usage when the ratings are exceeded could lead to wire breakage, burning, or other serious fault.

11.3 Inrush current

If an inrush current (or pulse current or rush current) that significantly exceeds the rated current is applied to the product, overheating could occur, resulting in wire breakage, burning, or other serious fault.

11.4 Corrosive gas

Please refrain from use since contact with environments with corrosive gases (sulfur gas [hydrogen sulfide, sulfur dioxide, etc.], chlorine, ammonia, etc.) or oils (cutting oil, silicone oil, etc.) that have come into contact with the previously stated corrosive gas environment will result in deterioration of product quality or an open from deterioration due to corrosion of product electrode, etc. We will not bear any responsibility for use under these environments.

12. Precautions for Use

This product is for use only with reflow soldering. It is designed to be mounted by soldering. If you want to use other mounting method, for example, using a conductive adhesive, please consult us beforehand.

Also, if repeatedly subjected to temperature cycles or other thermal stress, due to the difference in the coefficient of thermal expansion with the mounting substrate, the solder (solder fillet part) in the mounting part may crack.

The occurrence of cracks due to thermal stress is affected by the size of the land where mounted, the solder volume, and the heat dissipation of the mounting substrate. Carefully design it when a large change in ambient temperature is assumed.

12.1 Land dimensions

The following diagram shows the recommended land dimensions for reflow soldering.

The land dimensions are designed in consideration of electrical characteristics and mountability. Use of other land dimensions may preclude achievement of performance. In some cases, it may result in poor solderability, including positional shift. If you use other land pattern, consider it adequately.

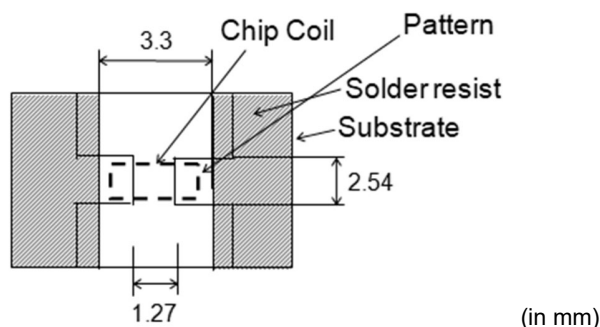

Do not use gilded pattern. A copper wire may cause open by dissolution of metallization.

12.2 Flux and solder used

Flux	<ul style="list-style-type: none"> • Use a rosin-based flux that includes an activator with a chlorine conversion value of 0.06(wt)% to 0.1(wt)%. • Do not use a highly acidic flux with a halide content exceeding 0.2(wt)% (chlorine conversion value). • Do not use a water-soluble flux.
Solder	<ul style="list-style-type: none"> • Use Sn-3.0Ag-0.5Cu solder. • Standard thickness of solder paste: 100 μm to 150 μm

If you want to use a flux other than the above, please consult our technical department.

12.3 Soldering conditions (reflow)

- Pre-heating should be in such a way that the temperature difference between solder and product surface is limited to 150°C max.
Cooling into solvent after soldering also should be in such a way that the temperature difference is limited to 100°C max. Insufficient pre-heating may cause cracks on the product, resulting in the deterioration of product quality.
- Standard soldering profile and the limit soldering profile is as follows.
The excessive limit soldering conditions may cause leaching of the electrode and/or resulting in the deterioration of product quality.



	Standard profile	Limit profile
Pre-heating	150°C to 180°C/90 s±30 s	150°C to 180°C/90 s±30 s
Heating	Above 220°C/30 s to 60 s	Above 230°C/60 s max.
Peak temperature	245°C±3°C	260°C/10 s
Number of reflow cycles	2 times	2 times

12.4 Reworking with soldering iron

The following requirements must be met to rework a soldered product using a soldering iron.

Item	Requirement
Pre-heating	150°C/approx. 1 min
Tip temperature of soldering iron	350°C max.
Power consumption of soldering iron	80 W max.
Tip diameter of soldering iron	ø3 mm max.
Soldering time	3 s (+1 s, -0 s)
Number of reworking operations	2 times max.
* Avoid a direct contact of the tip of the soldering iron with the product. Such a direction contact may cause cracks in the ceramic body due to thermal shock.	

12.5 Solder volume

Solder shall be used not to increase the volume too much.

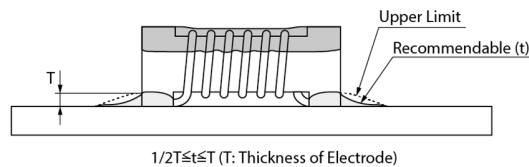

An increased solder volume increases mechanical stress on the product. Exceeding solder volume may cause the failure of mechanical or electrical performance.

12.6 Product's location

The following shall be considered when designing and laying out PCBs.

(1) PCB shall be designed so that products are not subject to mechanical stress due to warping the board.

[Products direction]

Products shall be located in the sideways direction (length: $a < b$) to the mechanical stress.



(2) Components location on PCB separation

It is effective to implement the following measures, to reduce stress in separating the board.

It is best to implement all of the following three measures; however, implement as many measures as possible to reduce stress.

Contents of measures	Stress level
(1) Turn the mounting direction of the component parallel to the board separation surface.	$A > D^{*1}$
(2) Add slits in the board separation part.	$A > B$
(3) Keep the mounting position of the component away from the board separation surface.	$A > C$
*1 $A > D$ is valid when stress is added vertically to the perforation as with hand separation. If a cutting disc is used, stress will be diagonal to the PCB, therefore $A > D$ is invalid.	

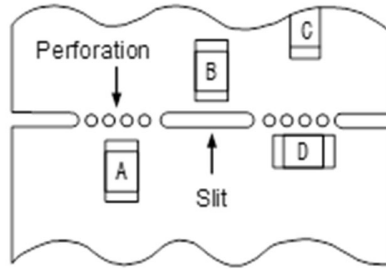

(3) Mounting components near screw holes

When a component is mounted near a screw hole, it may be affected by the board deflection that occurs during the tightening of the screw.

Mount the component in a position as far away from the screw holes as possible.

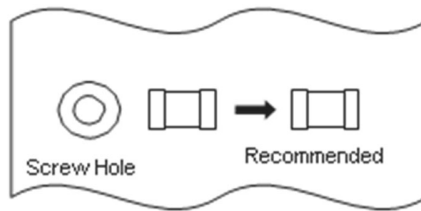

12.7 Handling of substrate

After mounting products on a substrate, do not apply any stress to the product caused by bending or twisting to the substrate when cropping the substrate, inserting and removing a connector from the substrate or tightening screw to the substrate. Excessive mechanical stress may cause cracking in the product.



Bending



Twisting

12.8 Cleaning

The product shall be cleaned under the following conditions.

- (1) The cleaning temperature shall be 60°C max. If isopropyl alcohol (IPA) is used, the cleaning temperature shall be 40°C max.
- (2) Perform ultrasonic cleaning under the following conditions. Exercise caution to prevent resonance phenomenon in mounted products and the PCB.

Item	Requirement
Power	20 W/L max.
Time	5 min max.
Frequency	28 kHz to 40 kHz

- (3) Cleaner

Alcohol-based cleaner: IPA

Aqueous agent: PINE ALPHA ST-100S

- (4) There shall be no residual flux or residual cleaner. When using aqueous agent, rinse the product with deionized water adequately and completely dry it so that no cleaner is left.

* For other cleaning, consult our technical department.

12.9 Storage and transportation

Storage period	Use the product within 12 months after delivery. If you do not use the product for more than 12 months, check solderability before using it.
Storage conditions	<ul style="list-style-type: none"> • The products shall be stored in a room not subject to rapid changes in temperature and humidity. The recommended temperature range is -10°C to +40°C. The recommended relative humidity range is 15% to 85%. Keeping the product in corrosive gases, such as sulfur, chlorine gas or acid, oxidizes the electrode, resulting in poor solderability or corrosion of the coil wire of the product. • Do not keep products in bulk packaging. Doing so may cause collision between the products or between the products and other products, resulting in core chipping or wire breakage. • Do not place the products directly on the floor; they should be placed on a palette so that they are not affected by humidity or dust. • Avoid keeping the products in a place exposed to direct sunlight, heat or vibration.
Transportation	Excessive vibration and impact reduces the reliability of the products. Exercise caution when handling the products.

12.10 Resin coating

The inductance value may change due to high cure-stress of resin to be used for coating/molding products.

A wire breakage issue may occur by mechanical stress caused by the resin, amount/cured shape of resin, or operating condition etc. Some resin contains some impurities or chloride possible to generate chlorine by hydrolysis under some operating condition may cause corrosion of wire of coil, leading to wire breakage.

So, please pay your careful attention when you select resin in case of coating/molding the products with the resin.

Prior to use the coating resin, please make sure no reliability issue is observed by evaluating products mounted on your board.

12.11 Handling of product

- Sharp material such as a pair of tweezers or other material such as bristles of cleaning brush, shall not be touched to the winding portion to prevent the breaking of wire.
- Mechanical shock should not be applied to the products mounted on the board to prevent the breaking of the core.

12.12 Handling with mounting equipment

With some types of mounting equipment, a support pin pushes up the product from the bottom of the base (paper) tape when the product is sucked with the pick-up nozzle.

When using this type of equipment, detach the support pin to prevent the breaking of wire on the product.

13. ⚠Note

- (1) Please make sure that your product has been evaluated in view of your specifications with our product being mounted to your product.
- (2) You are requested not to use our product deviating from the reference specifications.
- (3) The contents of this reference specification are subject to change without advance notice. Please approve our product specifications or transact the approval sheet for product specifications before ordering.

14. Appendix

Electrical performance: Measuring method for inductance/Q (Q measurement is applicable only when the Q value is included in the rating table.)

Perform measurement using the method described below. (Perform correction to ensure that the inductance value is compatible with inductors of other manufacturers.)

(1) Residual elements and stray elements of the measuring terminal can be expressed by the F parameter for the 2-pole terminal as shown in the figure below.

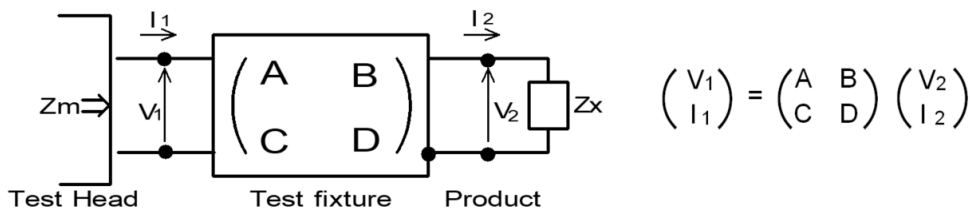

(2) The product's impedance value (Zx) and measured impedance value (Zm) can be expressed as shown below, by using the respective current and voltage for input/output.

$$Z_m = \frac{V_1}{I_1} \quad Z_x = \frac{V_2}{I_2}$$

(3) Thus, the relationship between the product's impedance value (Zx) and measured impedance value (Zm) is as follows.

$Z_x = \alpha \frac{Z_m - \beta}{1 - Z_m \Gamma}$	<p>Here,</p> <p>$\alpha = D/A = 1$</p> <p>$\beta = B/D = Z_{sm} - (1 - Y_{om} Z_{sm}) Z_{ss}$</p> <p>$\Gamma = C/A = Y_{om}$</p> <p>$Z_{sm}$: measured impedance when measuring terminal is shorted</p> <p>Z_{ss}: residual impedance of short chip (= Equivalent series inductance X*1)</p> <p>Y_{om}: measured admittance when measuring terminal is open</p>
---	---

*1 Important

X: In consideration of compatibility with other vendors' products, Zss is defined as the correction value to fit nominal inductance of other vendors' products.

When calibrating the measurement, please input X value instead of the equivalent series inductance (ShortL) for each L value.

Perform measurement of Q using the residual impedance 0.771 nH obtained through our conventional standard measurement method.

(4) Calculate inductance Lx and Qx using the equations shown below.



$L_x = \frac{\text{Im}(Z_x)}{2\pi f}$	<p>Lx: inductance of chip coil</p>
$Q_x = \frac{\text{Im}(Z_x)}{\text{Re}(Z_x)}$	<p>Qx: Q of chip coil</p> <p>f: measuring frequency</p>

Table: Equivalent series inductance to fit nominal inductance of other vendors' products

Part number	Inductance	
	X (nH) Equivalent series Inductance	Measuring frequency (MHz)
LQW2UAS12N_00	0.511	50
LQW2UAS18N_00	0.321	50
LQW2UAS22N_00	0.941	50
LQW2UAS27N_00	0.651	50
LQW2UAS33N_00	1.711	50
LQW2UAS39N_00	0.741	50
LQW2UAS47N_00	2.071	50
LQW2UAS56N_00	2.351	50
LQW2UAS68N_00	2.281	50
LQW2UAS82N_00	2.921	50
LQW2UASR10_00	3.351	25
LQW2UASR12_00	3.871	25
LQW2UASR15_00	4.371	25
LQW2UASR18_00	5.271	25
LQW2UASR22_00	3.271	25
LQW2UASR27_00	8.871	25
LQW2UASR33_00	12.771	25
LQW2UASR39_00	22.271	25
LQW2UASR47_00	20.971	25
LQW2UASR56_00	24.971	25
LQW2UASR62_00	28.371	25
LQW2UASR68_00	44.271	25
LQW2UASR75_00	35.371	25
LQW2UASR82_00	47.171	25
LQW2UASR91_00	56.371	25
LQW2UAS1R0_00	79.171	25
LQW2UAS1R2_00	15.771	7.9
LQW2UAS1R5_00	5.771	7.9
LQW2UAS1R8_00	6.771	7.9
LQW2UAS2R2_00	25.771	7.9
LQW2UAS2R7_00	63.771	7.9
LQW2UAS3R3_00	91.771	7.9
LQW2UAS3R9_00	67.771	7.9
LQW2UAS4R7_00	163.771	7.9

Looking for pricing, stock, or lifecycle information?

Click below to explore more details on WIN SOURCE:

-  [View LQW2UASR27J00L on WIN SOURCE](#)
-  [Murata Electronics North America Information](#)

Optimize Your Supply Chain with WIN SOURCE Solutions

-  Global Sourcing Solution
-  Obsolete Management
-  Cost Control Management
-  Shortage Management
-  Alternative Solution
-  Excess Inventory Management