



**THE DATASHEET OF
PE-0805CD560JTT**



RF CHIP INDUCTORS

Wire Wound - 0805 Series

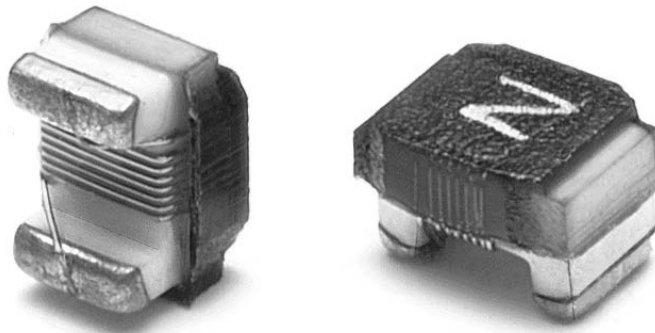





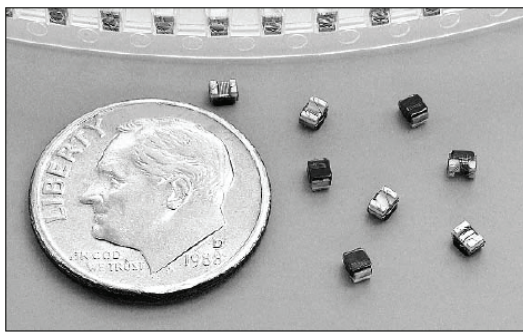

For More Information Please Visit: Networking.PulseElectronics.com

WIRE WOUND RF CHIP INDUCTORS

0805CD SERIES



-  Wire wound ceramic core construction
-  High Q values
-  High self resonant frequency
-  Temperature Range -40°C to +125°C
-  Industry 0805 (2012) size and surface mount land pattern
-  100% Tin Solder Termination

Electrical Specifications @ 25°C - Operating Temperature Range -40 °C to +125°C

| Part Number Tolerance +/-2% | Part Number Tolerance +/-5% | Inductance ¹ (nH) | Q ² (MIN) | SRF ³ (MHz MIN) | Rdc ⁴ (Ω MAX) | I _{dc} ⁵ (mA MAX) |
|--------------------------------|--------------------------------|---------------------------------|-------------------------|-------------------------------|-----------------------------|--|
| PE-0805CD030GTT | PE-0805CD030JTT | 3.32 @ 250MHz | 40 @ 1500MHz | 6000 | 0.08 | 600 |
| PE-0805CD050GTT | PE-0805CD050JTT | 5.6 @ 250MHz | 50 @ 1500MHz | 5500 | 0.10 | 600 |
| PE-0805CD080GTT | PE-0805CD080JTT | 7.9 @ 250MHz | 50 @ 1000MHz | 4700 | 0.12 | 600 |
| PE-0805CD100GTT | PE-0805CD100JTT | 10.2 @ 250MHz | 50 @ 500MHz | 4100 | 0.14 | 600 |
| PE-0805CD120GTT | PE-0805CD120JTT | 11.9 @ 250MHz | 50 @ 500MHz | 4000 | 0.15 | 600 |
| PE-0805CD150GTT | PE-0805CD150JTT | 14.9 @ 250MHz | 50 @ 500MHz | 3400 | 0.17 | 600 |
| PE-0805CD180GTT | PE-0805CD180JTT | 17.95 @ 250MHz | 50 @ 500MHz | 3300 | 0.20 | 600 |
| PE-0805CD220GTT | PE-0805CD220JTT | 21.7 @ 250MHz | 55 @ 500MHz | 2600 | 0.22 | 500 |
| PE-0805CD270GTT | PE-0805CD270JTT | 26.5 @ 250MHz | 55 @ 500MHz | 2500 | 0.25 | 500 |
| PE-0805CD330GTT | PE-0805CD330JTT | 32.75 @ 250MHz | 60 @ 500MHz | 2050 | 0.27 | 500 |
| PE-0805CD390GTT | PE-0805CD390JTT | 38.5 @ 250MHz | 60 @ 500MHz | 2000 | 0.29 | 500 |
| PE-0805CD470GTT | PE-0805CD470JTT | 46.6 @ 200MHz | 60 @ 500MHz | 1650 | 0.31 | 500 |
| PE-0805CD560GTT | PE-0805CD560JTT | 55.5 @ 200MHz | 60 @ 500MHz | 1550 | 0.34 | 500 |
| PE-0805CD680GTT | PE-0805CD680JTT | 67.8 @ 200MHz | 60 @ 500MHz | 1450 | 0.38 | 500 |
| PE-0805CD820GTT | PE-0805CD820JTT | 82.7 @ 150MHz | 60 @ 500MHz | 1300 | 0.42 | 400 |
| PE-0805CD101GTT | PE-0805CD101JTT | 98.7 @ 150MHz | 60 @ 500MHz | 1200 | 0.46 | 400 |
| PE-0805CD111GTT | PE-0805CD111JTT | 110 @ 150MHz | 50 @ 250MHz | 1000 | 0.48 | 400 |
| PE-0805CD121GTT | PE-0805CD121JTT | 119.7 @ 150MHz | 50 @ 250MHz | 1100 | 0.51 | 400 |
| PE-0805CD151GTT | PE-0805CD151JTT | 149.4 @ 100MHz | 50 @ 250MHz | 920 | 0.56 | 400 |
| PE-0805CD181GTT | PE-0805CD181JTT | 179.6 @ 100MHz | 50 @ 250MHz | 870 | 0.64 | 400 |
| PE-0805CD221GTT | PE-0805CD221JTT | 217 @ 100MHz | 45 @ 250MHz | 850 | 0.70 | 400 |
| PE-0805CD271GTT | PE-0805CD271JTT | 269 @ 100MHz | 45 @ 250MHz | 650 | 1.00 | 350 |
| PE-0805CD331GTT | PE-0805CD331JTT | 331 @ 100MHz | 45 @ 250MHz | 600 | 1.40 | 310 |
| PE-0805CD391GTT | PE-0805CD391JTT | 386 @ 50MHz | 35 @ 250MHz | 560 | 1.50 | 290 |

(Continued on next page)

WIRE WOUND RF CHIP INDUCTORS

0805CD SERIES

Electrical Specifications @ 25°C - Operating Temperature Range -40°C to +125°C (continued)

| Part Number Tolerance +/-2% | Part Number Tolerance +/-5% | Inductance ¹ (nH) | Q ² (MIN) | SRF ³ (MHz MIN) | Rdc ⁴ (Ω MAX) | I _{dc} ⁵ (mA MAX) |
|--------------------------------|--------------------------------|---------------------------------|-------------------------|-------------------------------|-----------------------------|--|
| PE-0805CD471GTT | PE-0805CD471JTT | 477 @ 25MHz | 33 @ 100MHz | 375 | 1.76 | 250 |
| PE-0805CD561GTT | PE-0805CD561JTT | 545 @ 25MHz | 23 @ 50MHz | 340 | 1.90 | 230 |
| PE-0805CD681GTT | PE-0805CD681JTT | 674 @ 25MHz | 23 @ 50MHz | 188 | 2.20 | 190 |
| PE-0805CD821GTT | PE-0805CD821JTT | 783 @ 25MHz | 23 @ 50MHz | 215 | 2.35 | 180 |
| PE-0805CD102GTT | PE-0805CD102JTT | 1000 @ 25MHz | 20 @ 50MHz | 200 | 3.60 | 150 |
| PE-0805CD122GTT | PE-0805CD122JTT | 1200 @ 25MHz | 20 @ 50MHz | 200 | 4.10 | 120 |
| N/A | PE-0805CD152JTT | 1500 @ 25MHz | 20 @ 50MHz | 200 | 5.00 | 100 |

Notes:

- Inductance measured using a HP4286A RF Impedance Analyzer. (Please note that inductance information is not stamped on part, because of the extremely small size).
- Q measured using a HP4291A RF Impedance Analyzer with a HP16193A Test Fixture.
- SRF measured using a HP8753C Network Analyzer.
- RDC measured using a Valhalla Scientific model 4100 ATC Digital Ohmmeter.
- Based on a 15°C maximum temperature rise.
- Check ordered tolerance band carefully:
To order a +/-2% tolerance band the ordering code ends with "GTT" while any +/-5% tolerance band ends with "JTT".

Typical Q vs Frequency

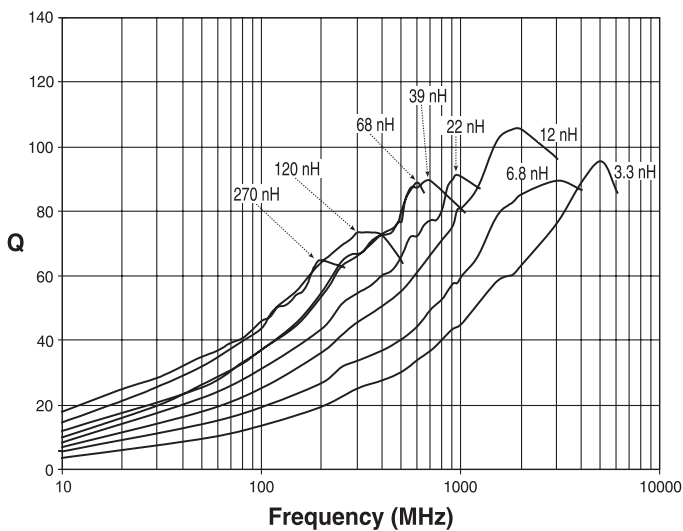

Typical Inductance vs Frequency

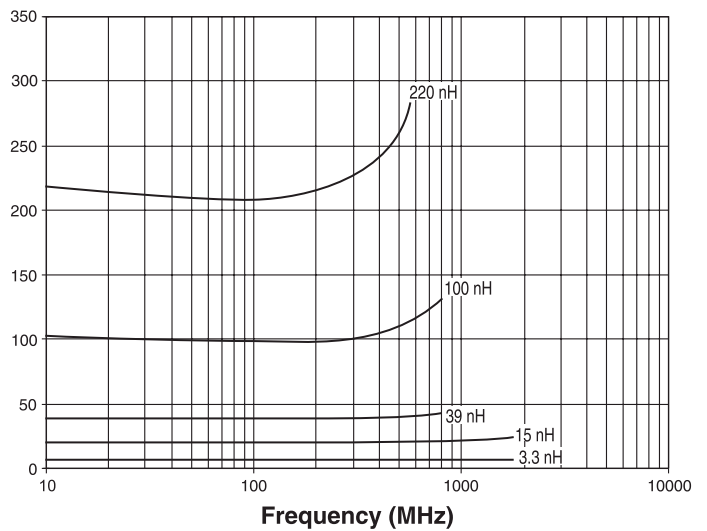

Mechanical

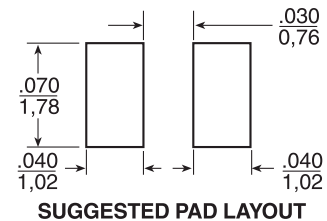
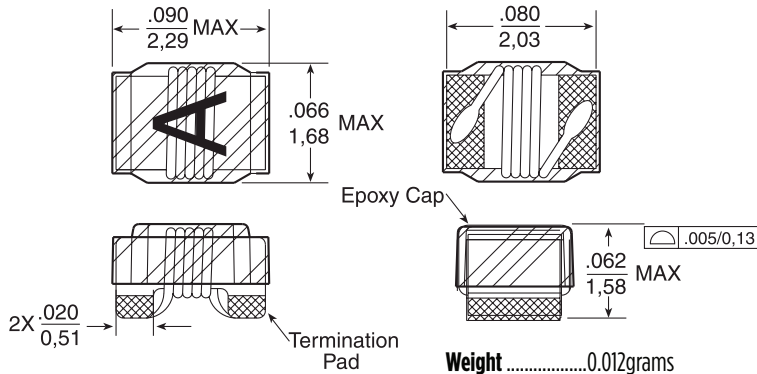

Dimensions: Inches / mm

Unless otherwise specified, all tolerances are ± .010 / 0,25

WIREWOUND RF CHIP INDUCTORS

0805FT SERIES

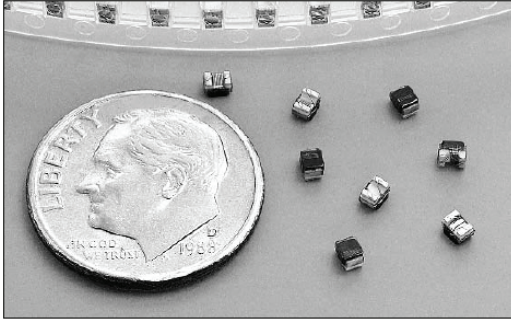

- Wire wound ferrite core construction
- High Q values
- High self resonant frequency
- Temperature Range -40°C to +125°C
- Industry standard 0805 (2012) size and surface mount land pattern
- 100% Tin Solder Termination

Electrical Specifications @ 25°C - Operating Temperature Range -40°C to +125°C

| Part Number Tolerance +/-5% | Inductance ¹ (μ H) | Q ² (MIN) | SRF ³ (MHz MIN) | Rdc ⁴ (Ω MAX) | I _{dc} ⁵ (mA MAX) |
|--------------------------------|---------------------------------------|-------------------------|-------------------------------|-------------------------------------|--|
| PE-0805FT102JTT | 1.0 @ 7.96MHz | 15 @ 7.96MHz | 63 | 1.20 | 245 |
| PE-0805FT152JTT | 1.5 @ 7.96MHz | 15 @ 7.96MHz | 60 | 1.45 | 225 |
| PE-0805FT222JTT | 2.2 @ 7.96MHz | 15 @ 7.96MHz | 58 | 1.80 | 200 |
| PE-0805FT332JTT | 3.3 @ 7.96MHz | 15 @ 7.96MHz | 50 | 2.30 | 175 |
| PE-0805FT472JTT | 4.7 @ 7.96MHz | 15 @ 7.96MHz | 43 | 2.80 | 140 |
| PE-0805FT682JTT | 6.8 @ 7.96MHz | 15 @ 7.96MHz | 36 | 3.40 | 115 |
| PE-0805FT103JTT | 10 @ 2.52MHz | 10 @ 2.52MHz | 30 | 4.70 | 98 |
| PE-0805FT153JTT | 15 @ 2.52MHz | 10 @ 2.52MHz | 23 | 6.50 | 80 |
| PE-0805FT223JTT | 22 @ 2.52MHz | 10 @ 2.52MHz | 20 | 8.00 | 68 |
| PE-0805FT333JTT | 33 @ 2.52MHz | 10 @ 2.52MHz | 17 | 10.70 | 60 |
| PE-0805FT473JTT | 47 @ 2.52MHz | 10 @ 2.52MHz | 14 | 13.80 | 55 |
| PE-0805FT683JTT | 68 @ 2.52MHz | 8 @ 2.52MHz | 11 | 17.50 | 49 |

- Notes:**
- Inductance measured using a HP4286A RF Impedance Analyzer. (Please note that inductance information is not stamped on part, because of the extremely small size).
 - Q measured using a HP4291A RF Impedance Analyzer with a HP16193A Test Fixture.
 - SRF measured using a HP8753C Network Analyzer.
 - RDC measured using a Valhalla Scientific model 4100 ATC Digital Ohmmer.
 - Based on a 15°C maximum temperature rise.

Mechanical

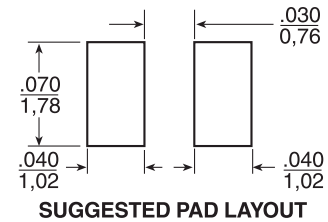
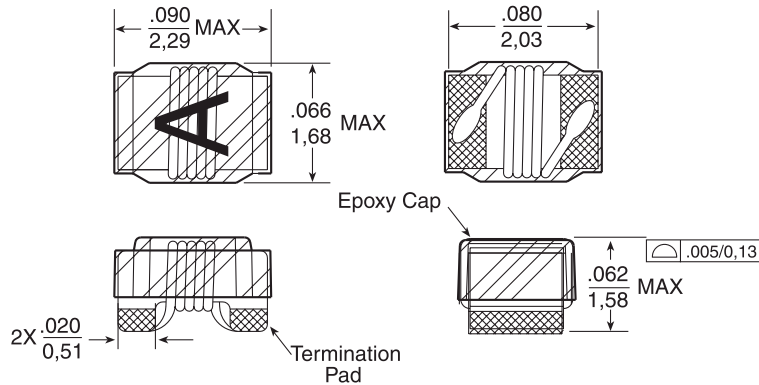

Dimensions: Inches / mm

Unless otherwise specified, all tolerances are $\pm \frac{.010}{0,25}$

Weight0.012grams

WIREWOUND RF CHIP INDUCTORS 0805FT SERIES

Typical Q vs Frequency

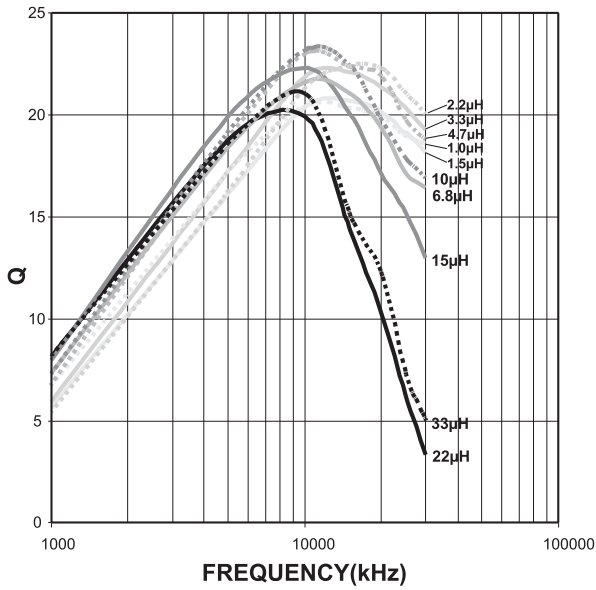

Typical Inductance vs Frequency

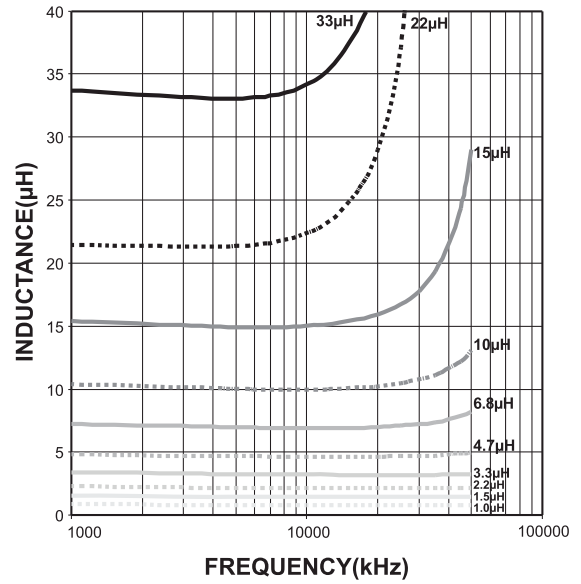

Tape and Reel Specifications

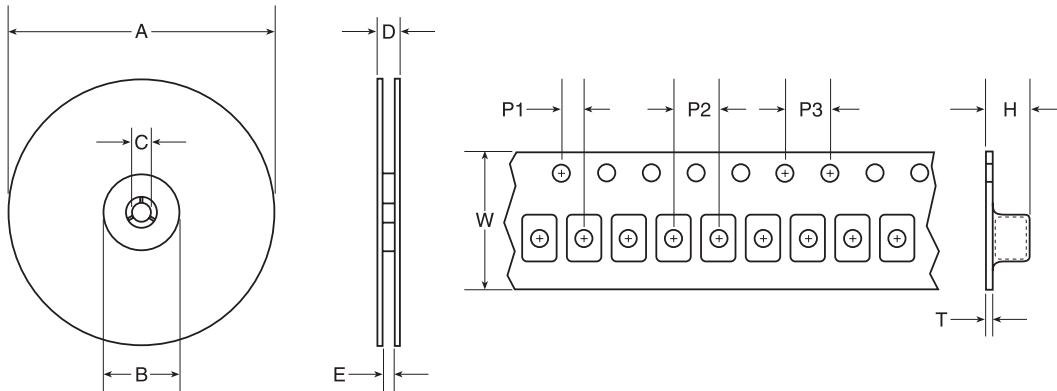

Packing Moisture Level = MSL 1 - Storage Temperature - 40°C to +125°C

| Series | Parts per Reel | Reels Dimensions (mm) | | | | | Tape Dimensions (mm) | | | | | |
|--------|----------------|-----------------------|----|----|------|-----|----------------------|----|----|----|-----|-----|
| | | A | B | C | D | E | W | P1 | P2 | P3 | H | T |
| 0805CD | 2000 | 178 | 50 | 13 | 14.4 | 8.4 | 8 | 2 | 4 | 4 | 2.1 | 0.3 |
| 0805FT | | | | | | | | | | | | |

Notes: P1, P2 and P3 are same for all chip inductor series. Keeping the same dimensions for guide hole and pocket pitch (P1), pocket pitch (P2), guide hole pitch (P3) and tape width (8mm) for all series, enables the packaging machine to maintain the same settings while changing models. The only difference between the series are the parts per reel which contributes to a different length of tapes/reel per model.

WIRE WOUND RF CHIP INDUCTORS

PERFORMANCE TESTING

Electrical Testing

| | | |
|--|---|--|
| Storage and Operating Temperature Range: -40°C to +125°C | Inductors are subjected to the extremes for 48 hours. Then tested at 25°C | There shall be no deformation or change in appearance Inductance shall not change by more than 35% Q values shall not change by more than 310% |
| Thermal: -40°C to +85°C | Inductors are subjected to 30 cycles for 30 minutes at each extreme. Then tested at 25°C | |
| Moisture Resistance 240 Hours at 70°C | Inductors are subjected to 10 cycles of 24 hours at 90 to 95% relative humidity Then tested at 24°C | |
| Operating Life | Inductors are subjected to 1000 hours at 85°C with 85% Relative Humidity with the rated current applied | |

Mechanical Testing

| Temperature Range: | Inductors are subjected to the following: Use a solder pot at 260°C, with RMA Flux. Each termination is immersed in 63Sn/37Pb molten solder for 4 to 6 seconds. | There shall be no deformation or change in appearance Inductance shall not change by more than 35% Q values shall not change by more than 310% | | | | | | | | | | | | | | | | | | | | | | | | | | | | |
|---|---|--|---------------|------------------|---|----|----|----|----|----|----|----|-----|-----|-----|-----|-----|-----|-----|-----|-----|-----|-----|-----|-----|-----|-----|-----|-----|-----|
| Recommended Solder Heat Resistance Profile | <table border="1"> <caption>Recommended Solder Heat Resistance Profile Data</caption> <thead> <tr> <th>Time (SECOND)</th> <th>Temperature (C°)</th> </tr> </thead> <tbody> <tr><td>0</td><td>25</td></tr> <tr><td>25</td><td>35</td></tr> <tr><td>50</td><td>50</td></tr> <tr><td>75</td><td>75</td></tr> <tr><td>100</td><td>125</td></tr> <tr><td>125</td><td>150</td></tr> <tr><td>150</td><td>175</td></tr> <tr><td>175</td><td>200</td></tr> <tr><td>200</td><td>225</td></tr> <tr><td>225</td><td>250</td></tr> <tr><td>250</td><td>225</td></tr> <tr><td>275</td><td>175</td></tr> <tr><td>300</td><td>150</td></tr> </tbody> </table> | | Time (SECOND) | Temperature (C°) | 0 | 25 | 25 | 35 | 50 | 50 | 75 | 75 | 100 | 125 | 125 | 150 | 150 | 175 | 175 | 200 | 200 | 225 | 225 | 250 | 250 | 225 | 275 | 175 | 300 | 150 |
| Time (SECOND) | Temperature (C°) | | | | | | | | | | | | | | | | | | | | | | | | | | | | | |
| 0 | 25 | | | | | | | | | | | | | | | | | | | | | | | | | | | | | |
| 25 | 35 | | | | | | | | | | | | | | | | | | | | | | | | | | | | | |
| 50 | 50 | | | | | | | | | | | | | | | | | | | | | | | | | | | | | |
| 75 | 75 | | | | | | | | | | | | | | | | | | | | | | | | | | | | | |
| 100 | 125 | | | | | | | | | | | | | | | | | | | | | | | | | | | | | |
| 125 | 150 | | | | | | | | | | | | | | | | | | | | | | | | | | | | | |
| 150 | 175 | | | | | | | | | | | | | | | | | | | | | | | | | | | | | |
| 175 | 200 | | | | | | | | | | | | | | | | | | | | | | | | | | | | | |
| 200 | 225 | | | | | | | | | | | | | | | | | | | | | | | | | | | | | |
| 225 | 250 | | | | | | | | | | | | | | | | | | | | | | | | | | | | | |
| 250 | 225 | | | | | | | | | | | | | | | | | | | | | | | | | | | | | |
| 275 | 175 | | | | | | | | | | | | | | | | | | | | | | | | | | | | | |
| 300 | 150 | | | | | | | | | | | | | | | | | | | | | | | | | | | | | |

Physical Specifications

| | | |
|----------------------------|--|--|
| Vibration (Random) | Samplers are subjected to random vibrations as per NAVMAT P9492 | There shall be no deformation or change in appearance Inductance shall not change by more than 35% Q values shall not change by more than 310% |
| Mechanical Shock | Inductors are subjected to one half sine wave pulse (8700 g's for 0.3ms) in each directional axis for a total of 18 shocks | |
| Moisture Resistance | Reflow Inductors on to test pads using 63Sn/37Pb solder paste (IR Reflow profile = 200°C for 30 seconds or peak 235°C for 20 seconds) | The inductors shall withstand a minimum force of 1000 g's in any direction using a dynamometer force guage |

Looking for pricing, stock, or lifecycle information?

Click below to explore more details on WIN SOURCE:

 [View PE-0805CD560JTT on WIN SOURCE](#)

 [Pulse Information](#)

Optimize Your Supply Chain with WIN SOURCE Solutions

-  Global Sourcing Solution
-  Obsolete Management
-  Cost Control Management
-  Shortage Management
-  Alternative Solution
-  Excess Inventory Management