



**THE DATASHEET OF  
PE-1008CD271GTT**



# *RF CHIP INDUCTORS*



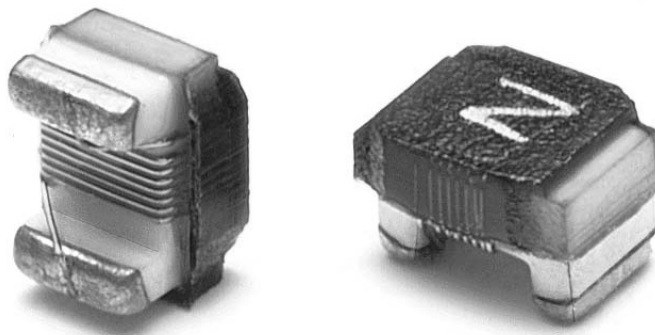



Wire Wound - 1008 Series

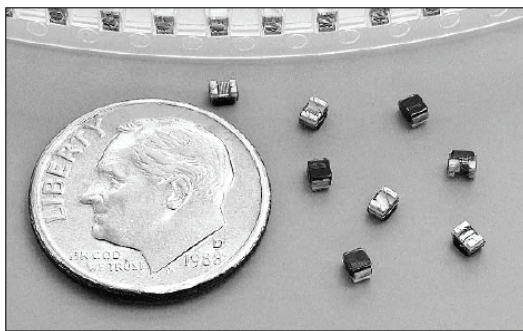

For More Information Please Visit: [Networking.PulseElectronics.com](http://Networking.PulseElectronics.com)

# WIRE WOUND RF CHIP INDUCTORS 1008CD SERIES



-  Wire wound ceramic core construction
-  High Q values
-  High self resonant frequency
-  Temperature Range -40°C to +125°C
-  Industry 1008 (2520) size and surface mount land pattern
-  100% Tin Solder Termination

Electrical Specifications @ 25°C - Operating Temperature Range -40 °C to +125°C

Part Number Tolerance +/-2%	Inductance <sup>1</sup> (nH)	Q <sup>2</sup> (MIN)	SRF <sup>3</sup> (MHz MIN)	Rdc <sup>4</sup> (Ω MAX)	I <sub>dc</sub> <sup>5</sup> (mA MAX)
PE-1008CD100GTT	10 @ 50MHz	50 @ 500MHz	4100.0	0.09	1000
PE-1008CD120GTT	12 @ 50MHz	50 @ 500MHz	3300.0	0.09	1000
PE-1008CD180GTT	17, 8 @ 50MHz	50 @ 350MHz	2500.0	0.11	1000
PE-1008CD220GTT	22 @ 50MHz	55 @ 350MHz	1800.0	0.12	1000
PE-1008CD270GTT	27 @ 50MHz	55 @ 350MHz	1500.0	0.11	1000
PE-1008CD330GTT	33 @ 50MHz	60 @ 350MHz	1600.0	0.14	1000
PE-1008CD390GTT	39 @ 50MHz	60 @ 350MHz	1400.0	0.12	1000
PE-1008CD470GTT	47 @ 50MHz	65 @ 350MHz	1200.0	0.08	1000
PE-1008CD560GTT	56 @ 50MHz	65 @ 350MHz	1160.0	0.09	1000
PE-1008CD680GTT	68 @ 50MHz	65 @ 350MHz	1100.0	0.07	1000
PE-1008CD820GTT	82 @ 50MHz	60 @ 350MHz	950.0	0.14	1000
PE-1008CD101GTT	100 @ 25MHz	60 @ 350MHz	900.0	0.15	650
PE-1008CD121GTT	120 @ 25MHz	60 @ 350MHz	950.0	0.63	650
PE-1008CD151GTT	150 @ 25MHz	45 @ 100MHz	625.0	0.16	580
PE-1008CD181GTT	180 @ 25MHz	45 @ 100MHz	650.0	0.77	620
PE-1008CD221GTT	220 @ 25MHz	45 @ 100MHz	625.0	0.84	500
PE-1008CD271GTT	270 @ 25MHz	45 @ 350MHz	525.0	0.91	500
PE-1008CD331GTT	330 @ 25MHz	45 @ 100MHz	500.0	1.05	450
PE-1008CD391GTT	390 @ 25MHz	45 @ 100MHz	475.0	1.12	470
PE-1008CD471GTT	470 @ 25MHz	45 @ 100MHz	450.0	1.19	420
PE-1008CD561GTT	560 @ 25MHz	45 @ 100MHz	415.0	1.33	310
PE-1008CD681GTT	680 @ 25MHz	45 @ 100MHz	375.0	1.47	230
PE-1008CD821GTT	820 @ 25MHz	45 @ 100MHz	350.0	1.61	180

(Continued on next page)

# WIRE WOUND RF CHIP INDUCTORS

## 1008CD SERIES

### Electrical Specifications @ 25°C - Operating Temperature Range -40°C to +125°C (continued)

Part Number Tolerance +/-2%	Inductance <sup>1</sup> (nH)	Q <sup>2</sup> (MIN)	SRF <sup>3</sup> (MHz MIN)	Rdc <sup>4</sup> (Ω MAX)	Ibc <sup>5</sup> (mA MAX)
PE-1008CD102GTT	1000 @ 25MHz	35 @ 50MHz	260.0	1.90	120
PE-1008CD122GTT	1200 @ 7.9MHz	35 @ 50MHz	250.0	2.00	310
PE-1008CD152GTT	1500 @ 7.9MHz	28 @ 50MHz	200.0	2.30	330
PE-1008CD182GTT	1800 @ 7.9MHz	28 @ 50MHz	160.0	2.60	300
PE-1008CD222GTT	2200 @ 7.9MHz	28 @ 50MHz	80.0	2.80	280
PE-1008CD272GTT	2700 @ 7.9MHz	22 @ 50MHz	90.0	3.20	290
PE-1008CD332GTT	3300 @ 7.9MHz	22 @ 25MHz	40.0	3.40	290

- Notes:**
- Inductance measured using a HP4286A RF Impedance Analyzer. (Please note that inductance information is not stamped on part, because of the extremely small size).
  - Q measured using a HP4291A RF Impedance Analyzer with a HP16193A Test Fixture
  - SRF measured using a HP8753C Network Analyzer.
  - RDC measured using a Valhalla Scientific model 4100 ATC Digital Ohmmeter.
  - Based on a 15°C maximum temperature rise,

### Typical Q vs Frequency

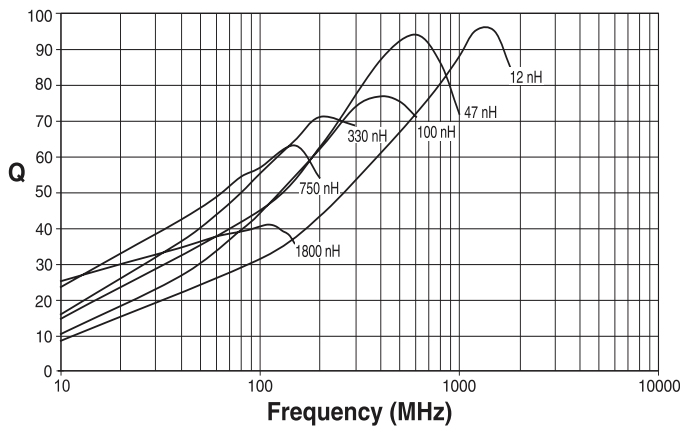

### Typical Inductance vs Frequency

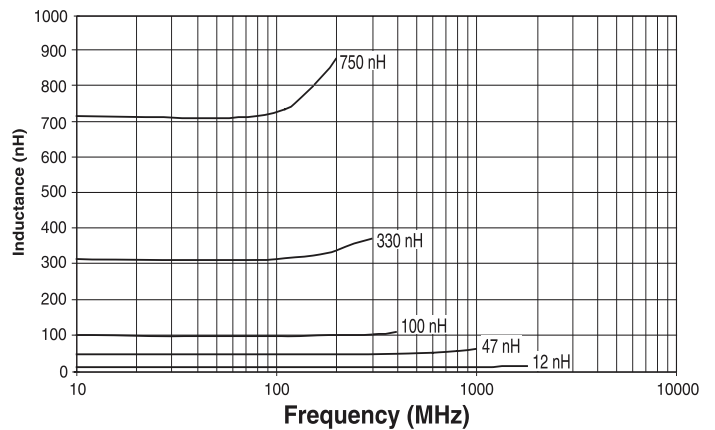

### Mechanical

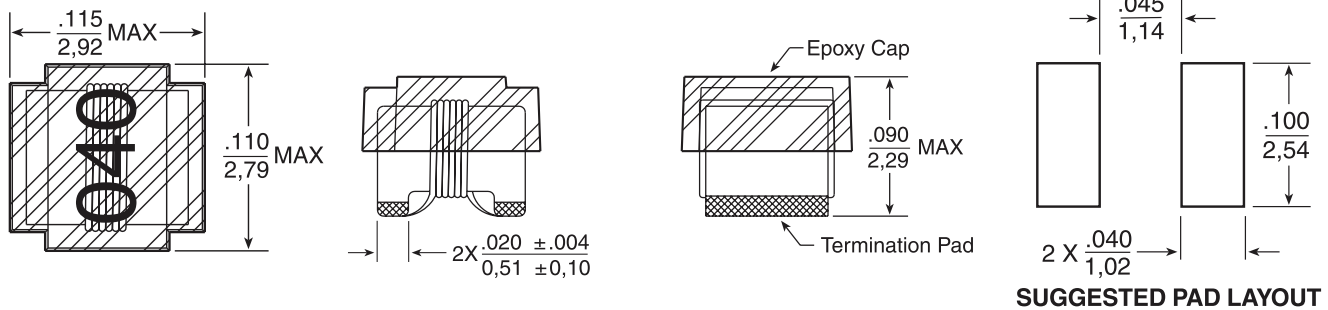

Weight .....0.032gram

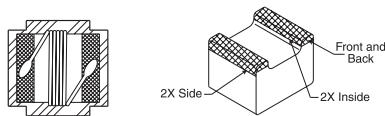

**Dimensions:** Inches  
mm

Unless otherwise specified,  
all tolerances are ±  $\frac{.010}{0,25}$

# WIRE WOUND RF CHIP INDUCTORS

## PERFORMANCE TESTING

### Electrical Testing

<p><b>Storage and Operating Temperature Range:</b></p> <p>-40°C to +125°C</p>	<p><i>Inductors are subjected to the extremes for 48 hours.</i></p> <p><i>Then tested at 25°C</i></p>	<p><i>There shall be no deformation or change in appearance</i></p>
<p><b>Thermal:</b></p> <p>-40°C to +85°C</p>	<p><i>Inductors are subjected to 30 cycles for 30 minutes at each extreme.</i></p> <p><i>Then tested at 25°C</i></p>	<p><i>Inductance shall not change by more than 35%</i></p>
<p><b>Moisture Resistance</b></p>	<p><i>Inductors are subjected to 10 cycles of 24 hours at 70°C with 90 to 95% Relative Humidity</i></p> <p><i>Then tested at 24°C</i></p>	<p><i>Q values shall not change by more than 310%</i></p>
<p><b>Operating Life</b></p>	<p><i>Inductors are subjected to 1000 hours at 85°C with 85% Relative Humidity with the rated current applied</i></p>	<p><i>There shall be no Damaged, Open or Shorted Windings</i></p>

### Mechanical Testing

<p><b>Temperature Range:</b></p>	<p><i>Inductors are subjected to the following: Use a solder pot at 260°C, with RMA Flux. Each termination is immersed in 63Sn/37Pb molten solder for 4 to 6 seconds.</i></p>	<p><i>There shall be no deformation or change in appearance</i></p> <p><i>Inductance shall not change by more than 35%</i></p> <p><i>Q values shall not change by more than 310%</i></p>
----------------------------------	---	--

**Recommended Solder Heat Resistance Profile**

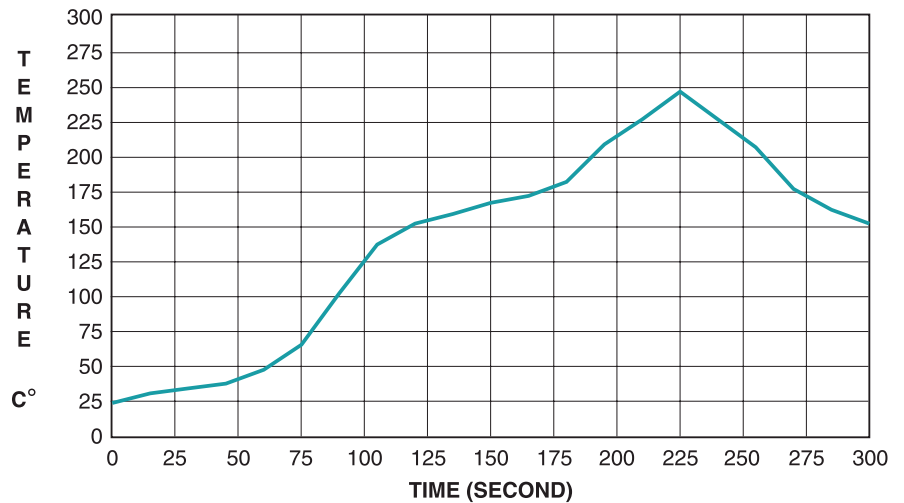

# WIRE WOUND RF CHIP INDUCTORS

## PERFORMANCE TESTING

### Physical Specifications

<b>Vibration (Random)</b>	<i>Samplers are subjected to random vibrations as per NAVMAT P9492</i>	There shall be no deformation or change in appearance
<b>Mechanical Shock</b>	<i>Inductors are subjected to one half sine wave pulse (8700 g's for 0.3ms) in each directional axis for a total of 18 shocks</i>	Inductance shall not change by more than 35% Q values shall not change by more than 310%
<b>Moisture Resistance</b>	<i>Reflow Inductors on to test pads using 63 Sn/37 Pb solder paste (IR Reflow profile: 200°C for 30 seconds or peak 235°C for 20 seconds)</i>	The inductors shall withstand a minimum force of 1000 g's in any direction using a dynamometer force gauge.

### Tape and Reel Specifications

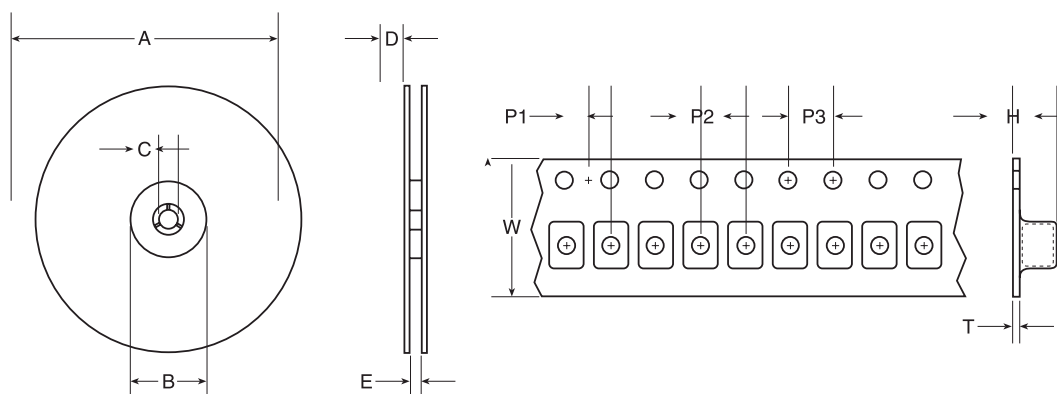

Packing Moisture Level = MSL 1 - Storage Temperature - 40°C to +125°C

Series	Parts per Reel	Reels Dimensions (mm)					Tape Dimensions (mm)					
		A	B	C	D	E	W	P1	P2	P3	H	T
PE-1008CD	1600	178	50	13	14.4	8.4	8	2	4	4	2.6	0.3

**Notes:** P1, P2 and P3 are same for all chip inductor series. Keeping the same dimensions for guide hole and pocket pitch (P1), pocket pitch (P2), guide hole pitch (P3) and tape width (8mm) for all series, enables the packaging machine to maintain the same settings while changing models. The only difference between the series are the parts per reel which contributes to a different length of tapes/reel per model.

## Looking for pricing, stock, or lifecycle information?

Click below to explore more details on WIN SOURCE:

 [View PE-1008CD271GTT on WIN SOURCE](#)

 [Pulse Information](#)

## Optimize Your Supply Chain with WIN SOURCE Solutions

-  Global Sourcing Solution
-  Obsolete Management
-  Cost Control Management
-  Shortage Management
-  Alternative Solution
-  Excess Inventory Management