



THE DATASHEET OF CDRH4D28NP-150NC



SMD Power Inductor CDRH4D28



Description

- Ferrite drum core construction.
- Magnetically shielded.
- L × W × H: 5.0 × 5.0 × 3.0 mm Max.
- Product weight: 0.2g(Ref.)
- Moisture Sensitivity Level: 1
- RoHS compliance.

Environmental Data

- Operating temperature range: -40°C ~ +100°C (including coil's self temperature rise)
- Storage temperature range: -40°C ~ +100°C
- Solder reflow temperature: 260 °C peak.

Packaging

- Carrier tape and reel packaging
- 12.9" diameter reel
- 2000pcs per reel

Applications

- Ideally used in Mobile phone, PDA, MP3, HDD, DSC/DVC, Note book PC, etc as DC-DC converter inductors.

Dimension - [mm]

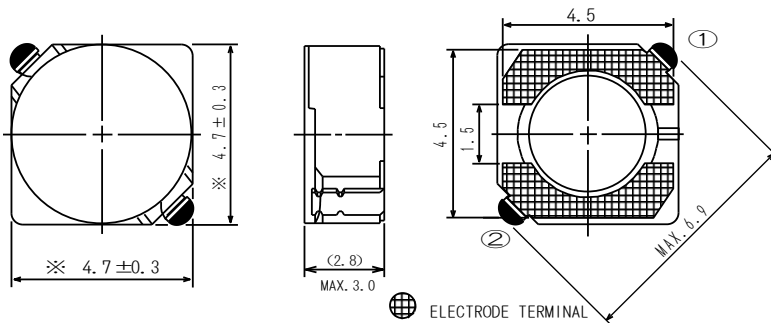

Land pattern and Schematics - [mm]

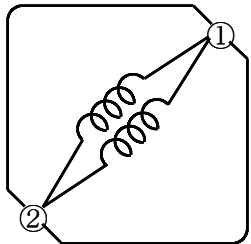
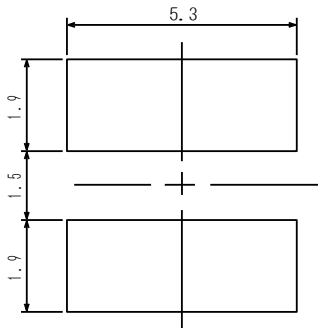

(1.2 μ H ~ 8.2 μ H)

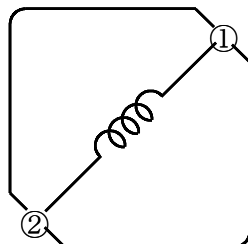

(10 μ H ~ 180 μ H)

SMD Power Inductor

CDRH4D28



Electrical Characteristics

Part No.	Stamp	Inductance (μH) [within] ※1	D.C.R.(Ω) Max. (Typ.) (at 20°C)	Rated Current (A) ※2
CDRH4D28NP-1R2NC	1R2	1.2 \pm 30%	23.6m(17.5m)	2.56
CDRH4D28NP-1R8NC	1R8	1.8 \pm 30%	27.5m(20.4m)	2.20
CDRH4D28NP-2R2NC	2R2	2.2 \pm 30%	31.3m(23.2m)	2.04
CDRH4D28NP-2R7NC	2R7	2.7 \pm 30%	43.3m(32.1m)	1.60
CDRH4D28NP-3R3NC	3R3	3.3 \pm 30%	49.2m(36.4m)	1.57
CDRH4D28NP-3R9NC	3R9	3.9 \pm 30%	64.8m(48.0m)	1.44
CDRH4D28NP-4R7NC	4R7	4.7 \pm 30%	72.0m(53.3m)	1.32
CDRH4D28NP-5R6NC	5R6	5.6 \pm 30%	100.9m(74.7m)	1.17
CDRH4D28NP-6R8NC	6R8	6.8 \pm 30%	108.9m(80.7m)	1.12
CDRH4D28NP-8R2NC	8R2	8.2 \pm 30%	117.5m(87.0m)	1.04
CDRH4D28NP-100NC	100	10 \pm 30%	128.3m(95.0m)	1.00
CDRH4D28NP-120NC	120	12 \pm 30%	131.6m(97.5m)	0.84
CDRH4D28NP-150NC	150	15 \pm 30%	149.0m(110.4m)	0.76
CDRH4D28NP-180NC	180	18 \pm 30%	166.0m(123.0m)	0.72
CDRH4D28NP-220NC	220	22 \pm 30%	235.0m(174.5m)	0.70
CDRH4D28NP-270NC	270	27 \pm 30%	261.0m(193.3m)	0.58
CDRH4D28NP-330NC	330	33 \pm 30%	331.3m(254.8m)	0.56
CDRH4D28NP-390NC	390	39 \pm 30%	383.7m(284.2m)	0.50
CDRH4D28NP-470NC	470	47 \pm 30%	587.0m(435.0m)	0.48
CDRH4D28NP-560NC	560	56 \pm 30%	624.5m(462.6m)	0.41
CDRH4D28NP-680NC	680	68 \pm 30%	699.0m(517.8m)	0.35
CDRH4D28NP-820NC	820	82 \pm 30%	914.8m(677.6m)	0.32
CDRH4D28NP-101NC	101	100 \pm 30%	1.02(765.8m)	0.29
CDRH4D28NP-121NC	121	120 \pm 30%	1.27(976.8m)	0.27
CDRH4D28NP-151NC	151	150 \pm 30%	1.35(1.08)	0.24
CDRH4D28NP-181NC	181	180 \pm 30%	1.54(1.23)	0.22

※1. Inductance measuring condition: at 100kHz.

※2. Rated current: The DC current at which the inductance decreases to 65% of its nominal value or when $\Delta t=40^\circ\text{C}$, whichever is lower ($T_a=20^\circ\text{C}$).

SMD Power Inductor CDRH4D28



Saturation Current & Temperature Rise Graph

— L (20°C) — L (100°C) — ΔT

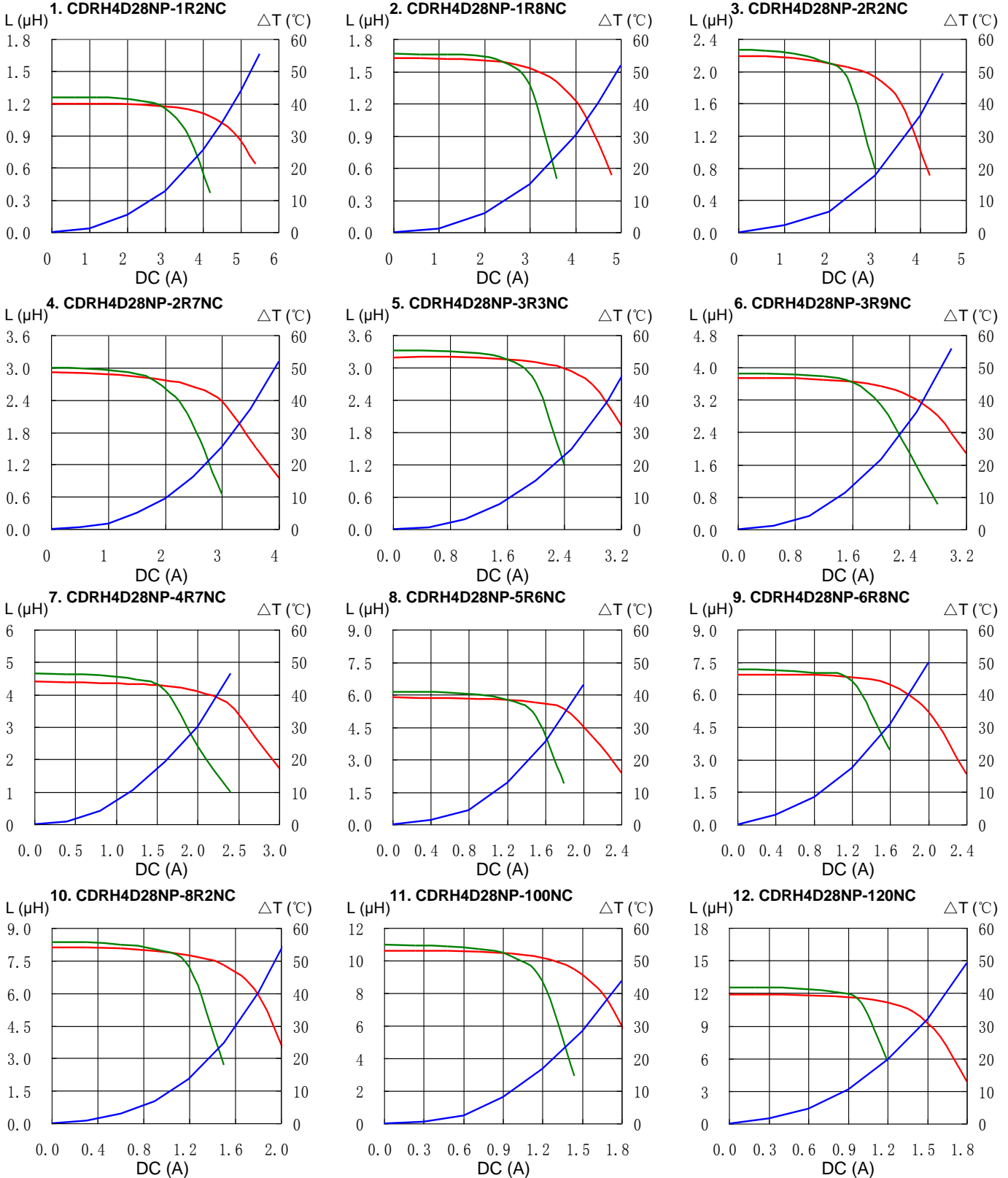

SMD Power Inductor CDRH4D28



Saturation Current & Temperature Rise Graph

— L (20°C) — L (100°C) — ΔT

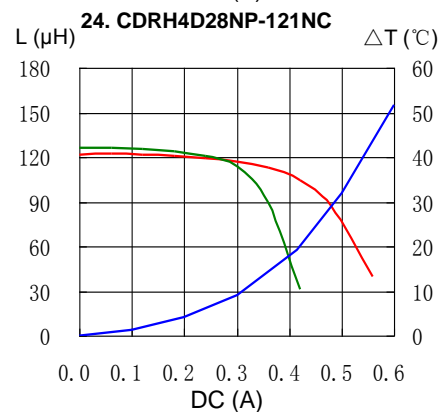
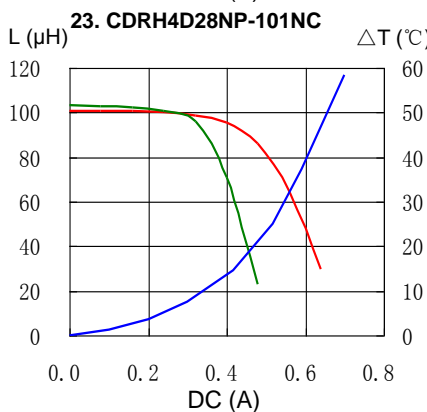
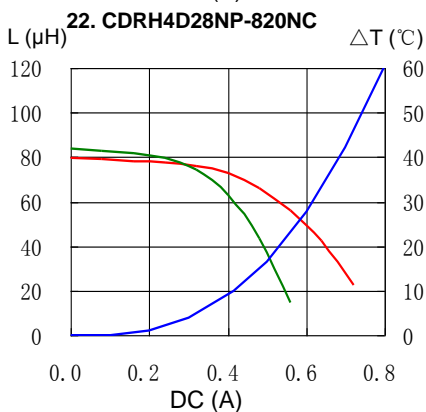
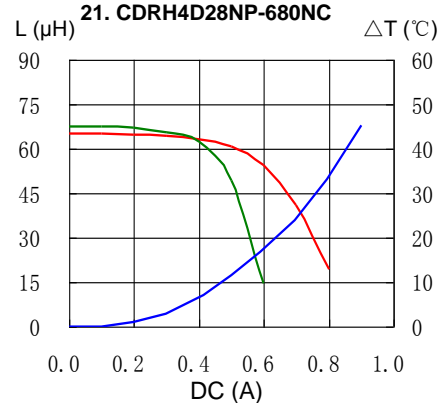
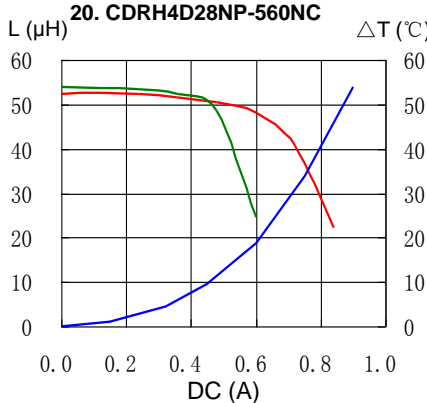
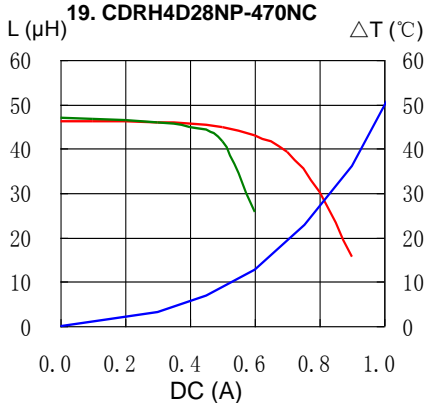
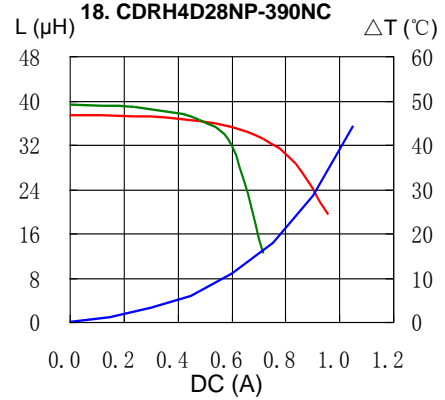
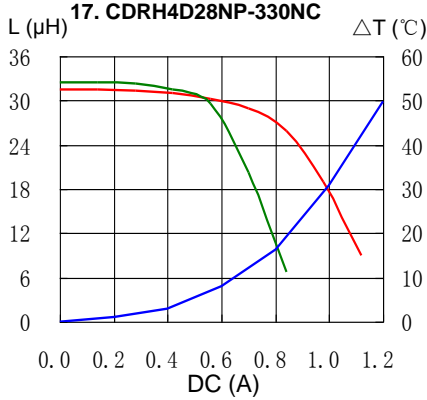
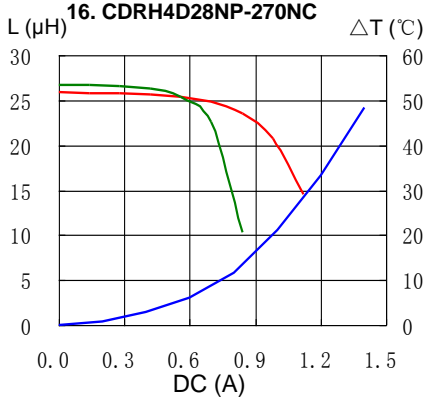
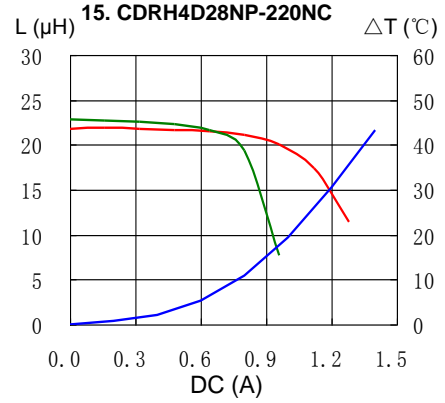
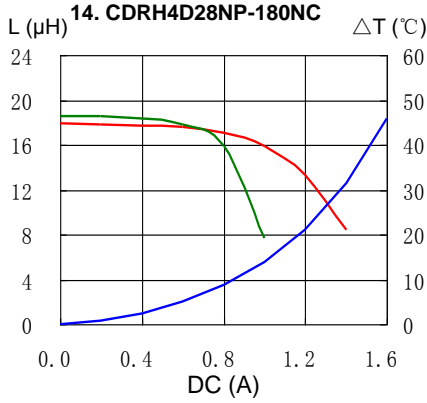
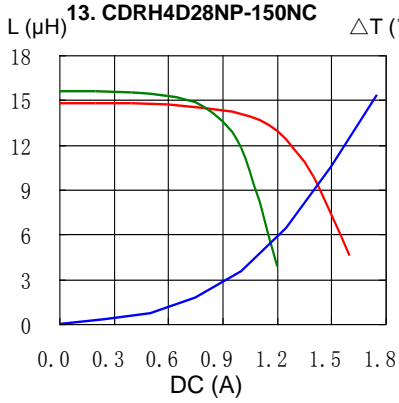

SMD Power Inductor CDRH4D28



Saturation Current & Temperature Rise Graph

— L (20°C) — L (100°C) — ΔT

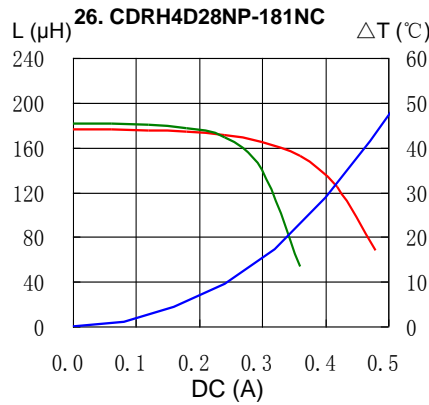
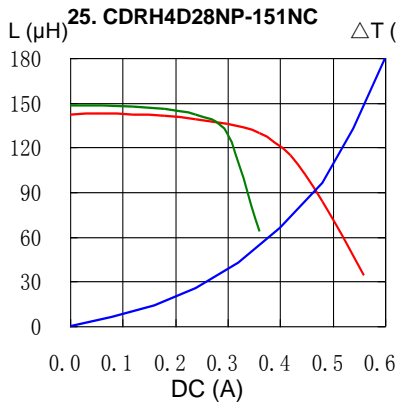

Solder Reflow Condition

Heat Endurance

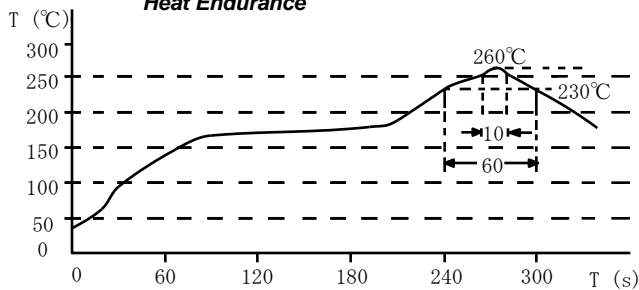

Temperature Chart

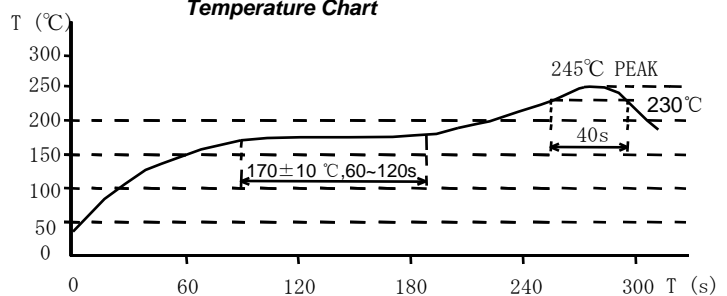

Please refer to the sales offices on our website - <http://www.sumida.com>

Hong Kong

Tel.+852-2880-6781
FAX.+852-2565-9600
sales@hk.sumida.com

Saitama(Japan)

Tel.+81-48-691-7300
FAX.+81-48-691-7340
sales@jp.sumida.com

Chicago

Tel.+1-847-545-6700
FAX. +1-847-545-6720
sales@us.sumida.com

Shanghai

Tel.+86-21-5836-3299
FAX.+86-21-5836-3266
shanghai.sales@cn.sumida.com

Seoul

Tel.+82-2-6237-0777
FAX.+82-2-6237-0778
sales@kr.sumida.com

Obernzell

Tel.+49-8591-937-0
FAX. +49-8591-937-103
contact@eu.sumida.com

Shenzhen

Tel.+86-755-8291-0228
FAX.+86-755-8291-0338
shenzhen.sales@cn.sumida.com

Singapore

Tel.+65-6296-3388
FAX.+65-6841-4426
sales@sg.sumida.com

Neumarkt

Tel.+49-9181-4509-110
FAX. +49-9181-4509-310
infocomp@eu.sumida.com

Taipei

Tel.+886-2-8751-2737
FAX.+886-2-8751-2738
sales@tw.sumida.com

San Jose

Tel.+1-408-321-9660
FAX.+1-408-321-9308
sales@us.sumida.com

Looking for pricing, stock, or lifecycle information?

Click below to explore more details on WIN SOURCE:

- ⊖ [View CDRH4D28NP-150NC on WIN SOURCE](#)
- ⊖ [Sumida America Components Inc. Information](#)

Optimize Your Supply Chain with WIN SOURCE Solutions

- ✓ Global Sourcing Solution
- ✓ Obsolete Management
- ✓ Cost Control Management
- ✓ Shortage Management
- ✓ Alternative Solution
- ✓ Excess Inventory Management