

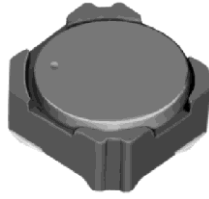

**THE DATASHEET OF  
CDR7D28MNNP-3R6NC**



# SMD Power Inductor CDR7D28MN



## Description

- Ferrite drum core construction.
- Magnetically shielded.
- L × W × H: 7.6 × 7.6 × 3.0 mm Max.
- Product weight: 0.46g(Ref.)
- Moisture Sensitivity Level: 1
- RoHS compliance.

## Environmental Data

- Operating temperature range: -40°C ~ +105°C (including coil's self temperature rise)
- Storage temperature range: -40°C ~ +105°C
- Solder reflow temperature: 260 °C peak.

## Packaging

- Carrier tape and reel packaging
- 12.9" diameter reel
- 1000pcs per reel

## Applications

- Ideally used in LCD driver, DSC/DVC , Notebook PC or the other portable equipment

## Dimension - [mm]

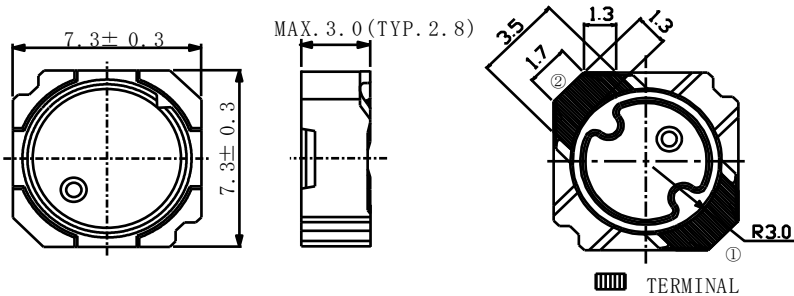

## Land pattern and Schematics - [mm]

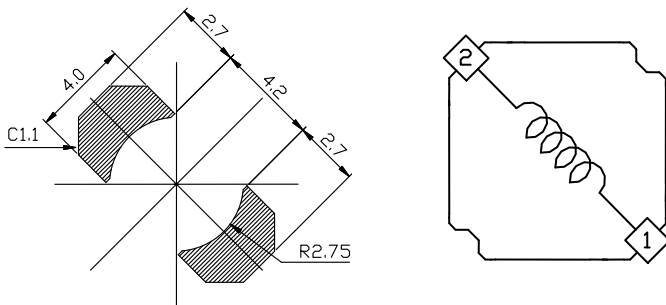

# SMD Power Inductor

## CDR7D28MN



### Electrical Characteristics

Part Name	Stamp	Inductance ( $\mu\text{H}$ ) [Within] ※1	D.C.R. (m $\Omega$ ) Max. (Typ.) (at 20°C)	Saturation Current (A) ※2		Temperature rise current: (A) ※3
				(at 20°C)	(at 105°C)	
CDR7D28MNNP-1R2 NC	1R2	1.2 $\mu\text{H} \pm 25\%$	20.5(16.4)	5.90	4.65	4.50
CDR7D28MNNP-2R0 NC	2R0	2.0 $\mu\text{H} \pm 25\%$	23.8(19)	4.55	3.65	3.95
CDR7D28MNNP-2R7 NC	2R7	2.7 $\mu\text{H} \pm 25\%$	27.5(22)	4.10	3.30	3.70
CDR7D28MNNP-3R6 NC	3R6	3.6 $\mu\text{H} \pm 25\%$	32.5(26)	3.55	2.90	3.45
CDR7D28MNNP-4R6 NC	4R6	4.6 $\mu\text{H} \pm 25\%$	37.5(30)	3.30	2.65	3.20
CDR7D28MNNP-6R8 NC	6R8	6.8 $\mu\text{H} \pm 25\%$	46.3(37)	2.90	2.45	2.75
CDR7D28MNNP-8R0 NC	8R0	8.0 $\mu\text{H} \pm 25\%$	50.0(40)	2.60	2.10	2.60
CDR7D28MNNP-100 NC	100	10 $\mu\text{H} \pm 25\%$	53.8(48)	2.40	1.95	2.50
CDR7D28MNNP-150 NC	150	15 $\mu\text{H} \pm 25\%$	81.3(65)	2.10	1.65	2.00
CDR7D28MNNP-220 NC	220	22 $\mu\text{H} \pm 25\%$	120.0(96)	1.65	1.35	1.60
CDR7D28MNNP-330 NC	330	33 $\mu\text{H} \pm 25\%$	196.3(157)	1.35	1.10	1.20
CDR7D28MNNP-470 NC	470	47 $\mu\text{H} \pm 25\%$	275.0(220)	1.05	0.85	1.00
CDR7D28MNNP-680 NC	680	68 $\mu\text{H} \pm 25\%$	425.0(340)	0.90	0.70	0.78
CDR7D28MNNP-101 NC	101	100 $\mu\text{H} \pm 25\%$	655.0(524)	0.75	0.60	0.65
CDR7D28MNNP-151 NC	151	150 $\mu\text{H} \pm 25\%$	950.0(760)	0.60	0.45	0.52
CDR7D28MNNP-221 NC	221	220 $\mu\text{H} \pm 25\%$	1320(1100)	0.50	0.40	0.40
CDR7D28MNNP-331 NC	331	330 $\mu\text{H} \pm 25\%$	2184(1820)	0.35	0.30	0.31
CDR7D28MNNP-471 NC	471	470 $\mu\text{H} \pm 25\%$	2652(2210)	0.30	0.25	0.28

※1. Inductance measuring condition: at 100kHz.

※2. Saturation current: The value of D.C. current when the inductance decreases to 65% of its nominal value.

※3. Temperature rise current: The value of D.C. current when the temperature rise is  $\Delta t = 40^\circ\text{C}$  ( $T_a = 20^\circ\text{C}$ ).

# SMD Power Inductor CDR7D28MN

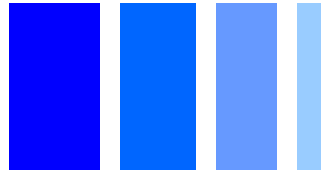

## Saturation Current & Temperature Rise Graph

— L (20°C) — L (100°C) —  $\Delta T$

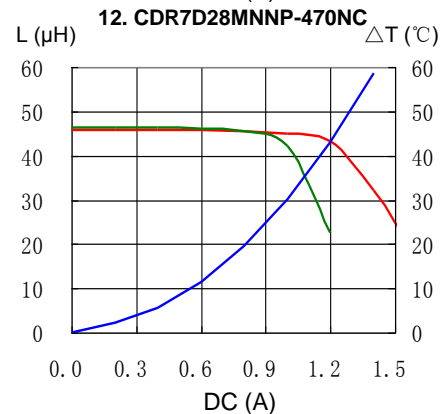
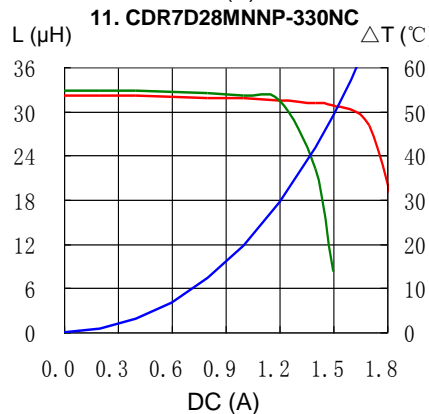
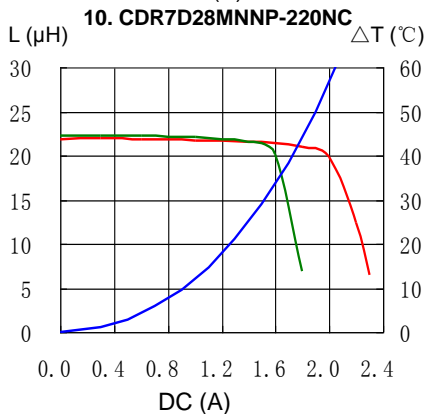
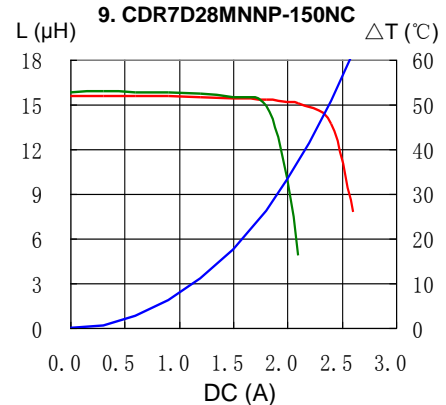
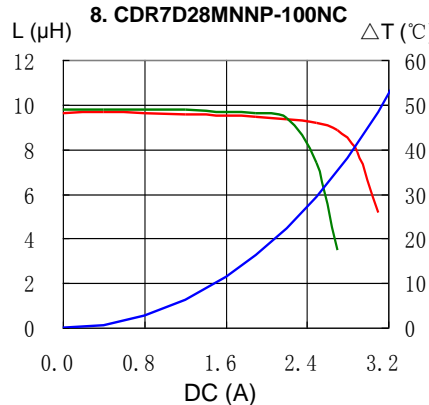
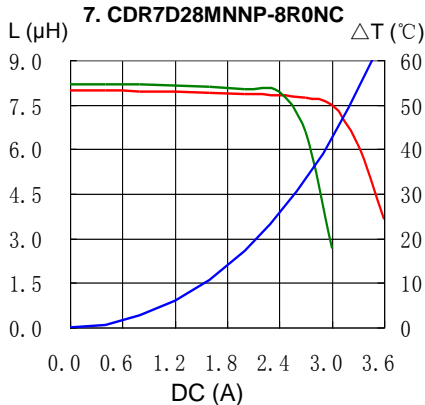
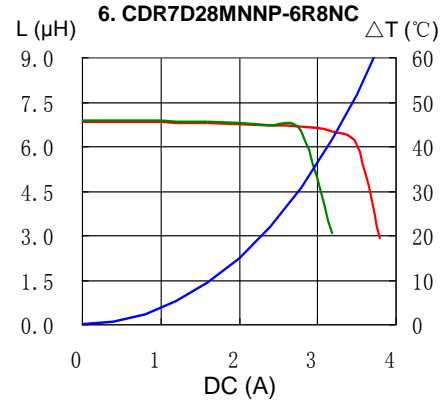
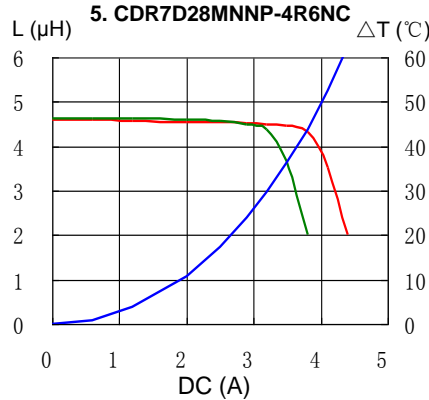
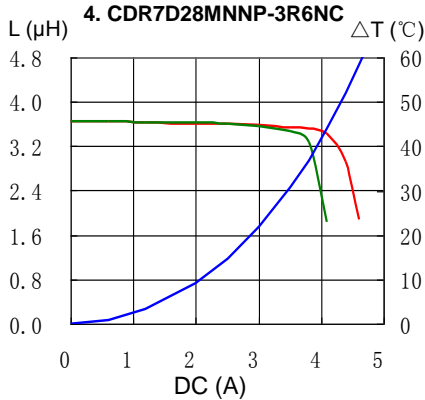
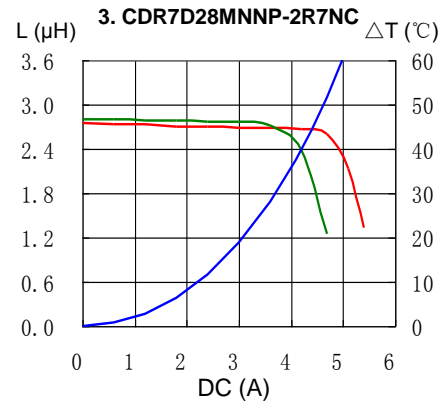
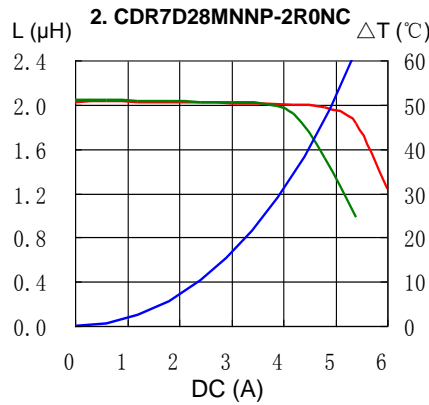
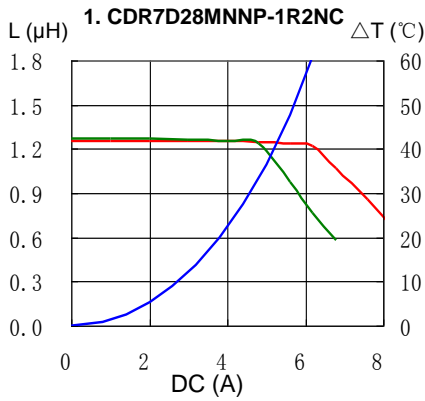

# SMD Power Inductor CDR7D28MN

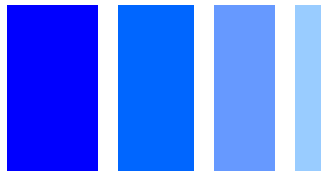

## Saturation Current & Temperature Rise Graph

— L (20°C) — L (100°C) —  $\Delta T$

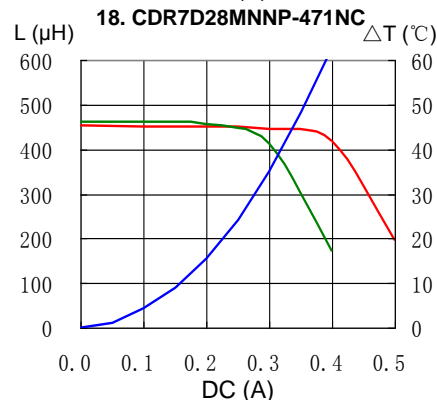
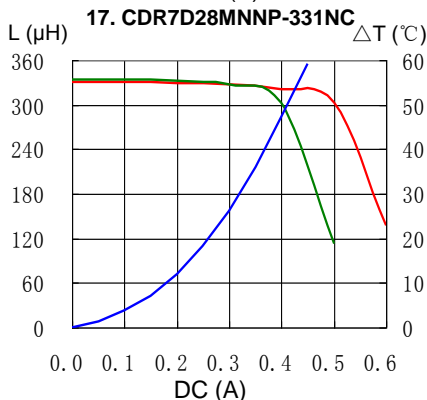
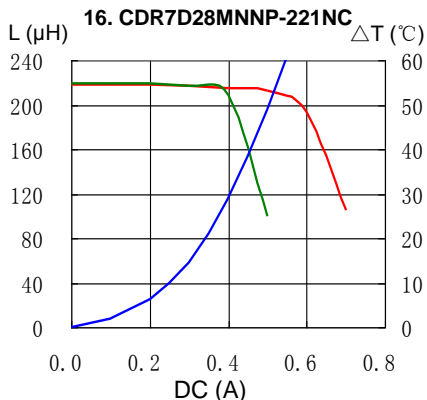
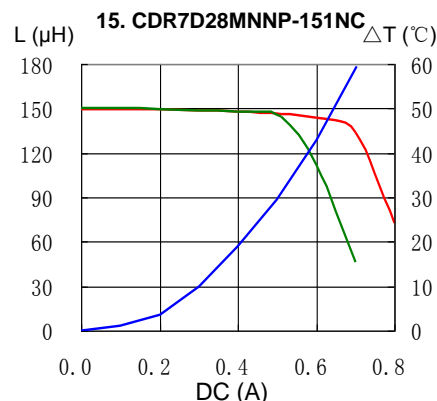
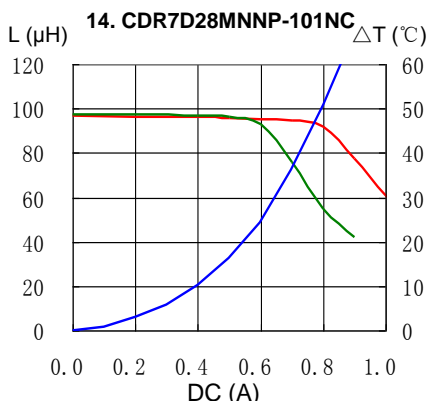
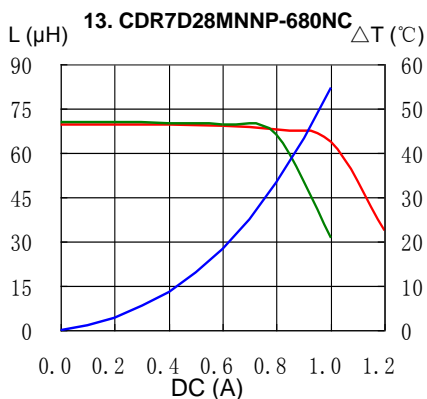

## Solder Reflow Condition

Heat Endurance

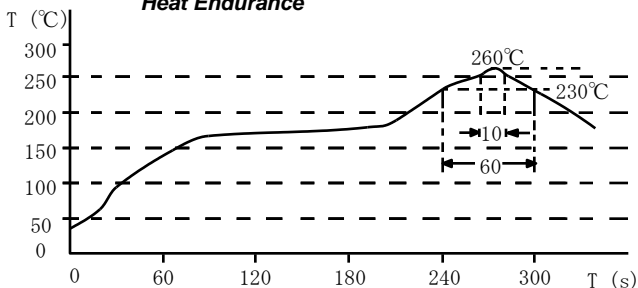

Temperature Chart

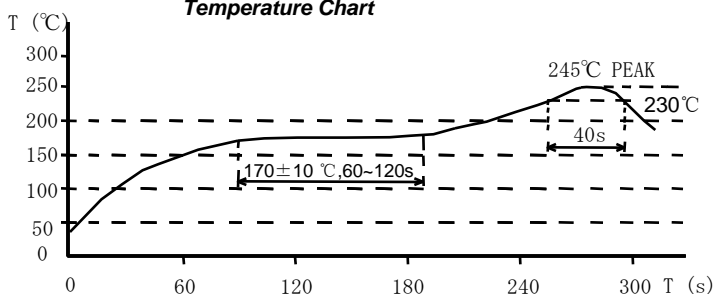

Please refer to the sales offices on our website - <http://www.sumida.com>

### Hong Kong

Tel.+852-2880-6781  
FAX.+852-2565-9600  
[sales@hk.sumida.com](mailto:sales@hk.sumida.com)

### Saitama(Japan)

Tel.+81-48-691-7300  
FAX.+81-48-691-7340  
[sales@jp.sumida.com](mailto:sales@jp.sumida.com)

### Chicago

Tel.+1-847-545-6700  
FAX. +1-847-545-6720  
[sales@us.sumida.com](mailto:sales@us.sumida.com)

### Shanghai

Tel.+86-21-5836-3299  
FAX.+86-21-5836-3266  
[shanghai.sales@cn.sumida.com](mailto:shanghai.sales@cn.sumida.com)

### Seoul

Tel.+82-2-6237-0777  
FAX.+82-2-6237-0778  
[sales@kr.sumida.com](mailto:sales@kr.sumida.com)

### Obernzell

Tel.+49-8591-937-0  
FAX. +49-8591-937-103  
[contact@eu.sumida.com](mailto:contact@eu.sumida.com)

### Shenzhen

Tel.+86-755-8291-0228  
FAX.+86-755-8291-0338  
[shenzhen.sales@cn.sumida.com](mailto:shenzhen.sales@cn.sumida.com)

### Singapore

Tel.+65-6296-3388  
FAX.+65-6841-4426  
[sales@sg.sumida.com](mailto:sales@sg.sumida.com)

### Neumarkt

Tel.+49-9181-4509-110  
FAX. +49-9181-4509-310  
[infocomp@eu.sumida.com](mailto:infocomp@eu.sumida.com)

### Taipei

Tel.+886-2-8751-2737  
FAX.+886-2-8751-2738  
[sales@tw.sumida.com](mailto:sales@tw.sumida.com)

### San Jose

Tel.+1-408-321-9660  
FAX.+1-408-321-9308  
[sales@us.sumida.com](mailto:sales@us.sumida.com)

## Looking for pricing, stock, or lifecycle information?

Click below to explore more details on WIN SOURCE:

- ⊖ [View CDR7D28MNNP-3R6NC on WIN SOURCE](#)
- ⊖ [Sumida America Components Inc. Information](#)

## Optimize Your Supply Chain with WIN SOURCE Solutions

- ✓ Global Sourcing Solution
- ✓ Obsolete Management
- ✓ Cost Control Management
- ✓ Shortage Management
- ✓ Alternative Solution
- ✓ Excess Inventory Management