

0.5A SURFACE MOUNT GLASS PASSIVATED FAST RECOVERY BRIDGE RECTIFIER

Features

- Glass Passivated Die Construction
- Low Forward Voltage Drop
- Surge Overload Rating to 30A Peak
- Ideally Suited for Automatic Assembly
- Miniature Package Saves Space on PC Boards
- **Lead Free Finish, RoHS Compliant (Note 4)**

Mechanical Data

- Case: MiniDIP
- Case Material: Molded Plastic. UL Flammability Classification Rating 94V-0
- Terminals: Finish — Bright Tin. Plated Leads, Solderable per MIL-STD-202, Method 208
- Polarity: As Marked on Case
- Marking: Type Number
- Weight: 0.125 grams (approx.)

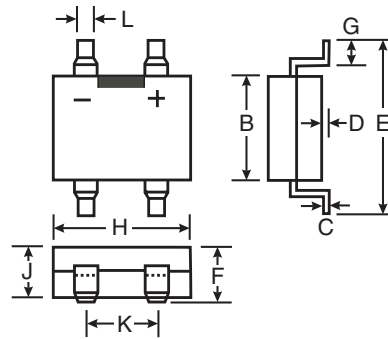

MiniDIP		
Dim	Min	Max
B	3.6	4.0
C	0.15	0.35
D	—	0.20
E	—	7.0
F	—	3.00
G	0.70	1.10
H	4.5	4.9
J	2.3	2.7
K	2.3	2.7
L	0.50	0.80
All Dimensions in mm		

Maximum Ratings and Electrical Characteristics @ T_A = 25°C unless otherwise specified

Characteristic	Symbol	RH02	RH04	RH06	Unit
Peak Repetitive Reverse Voltage Working Peak Reverse Voltage DC Blocking Voltage	V _{RRM} V _{RWM} V _{DC}	200	400	600	V
RMS Reverse Voltage	V _{RMS}	140	280	420	V
Average Forward Rectified Current (Note 1) T _A = @ 40°C	I _O	0.5			A
Non-Repetitive Peak Forward Surge Current, 8.3 ms Single half-sine-wave Superimposed on Rated Load (JEDEC method)	I _{FSM}	30			A
Instantaneous Voltage Drop @ 0.4A (per element)	V _F	1.15			V
Peak Reverse Current at Rated DC Blocking Voltage (per element)	I _R	5.0 100			μA
Maximum Reverse Recovery Time (Note 3)	t _{rr}	150		250	ns
Typical Junction Capacitance (per element) (Note 2)	C _j	13.0			pF
Typical Thermal Resistance, Junction to Ambient (Note 1)	R _{θJA}	85			K/W
Operating and Storage Temperature Range	T _j , T _{STG}	-55 to +150			°C

- Notes:
1. Mounted on Glass Epoxy PC Board.
 2. Measured at 1.0 MHz and Applied Reverse Voltage of 4.0 V.
 3. t_{rr} test conditions: I_F = 0.5A, I_R = 1.0A, I_{rr} = 0.25A.
 4. RoHS revision 13.2.2003. Glass and High Temperature Solder Exemptions Applied, see *EU Directive Annex Notes 5 and 7*.

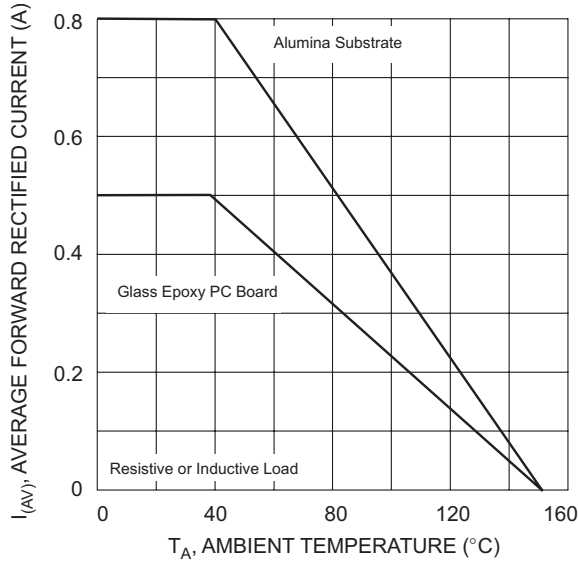

Fig. 1 Output Current Derating Curve

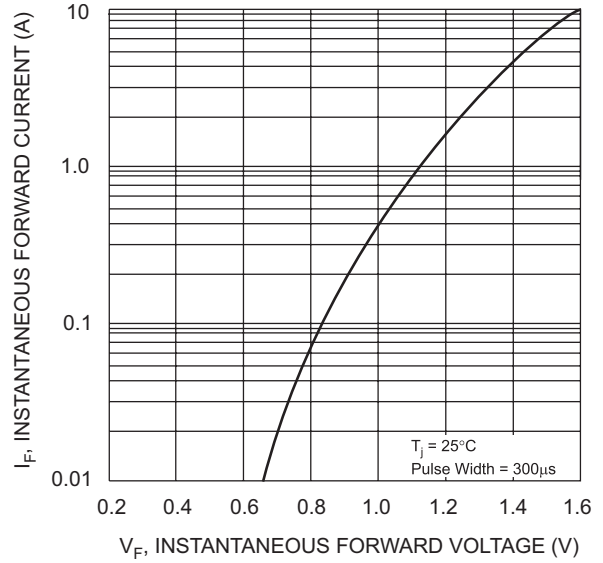

Fig. 2 Typical Forward Characteristics (per leg)

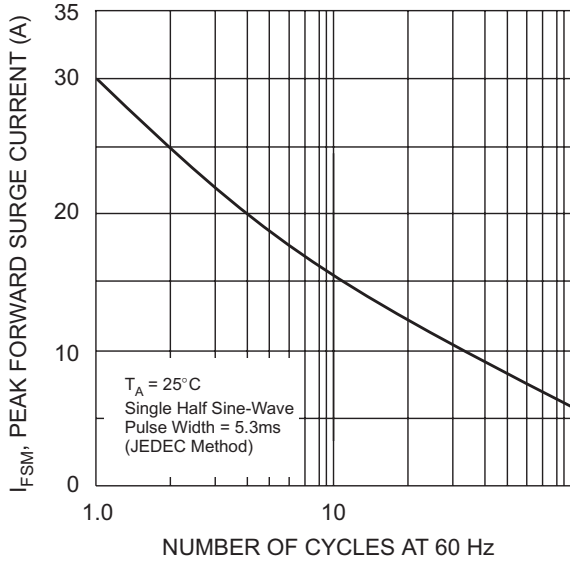

Fig. 3 Maximum Peak Forward Surge Current (per leg)

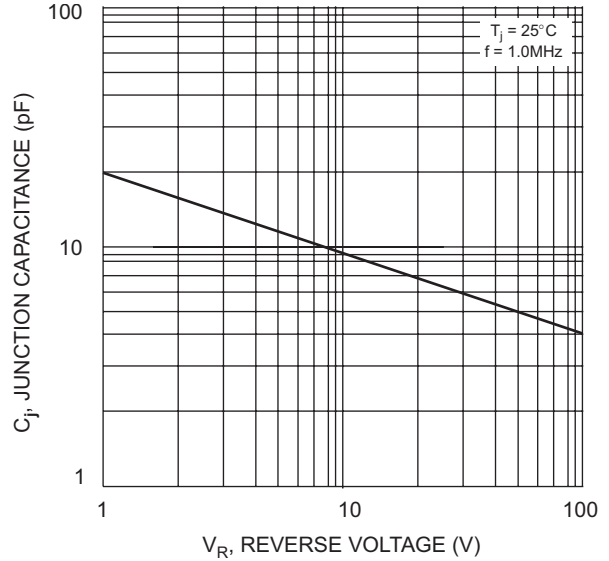

Fig. 4 Typical Junction Capacitance

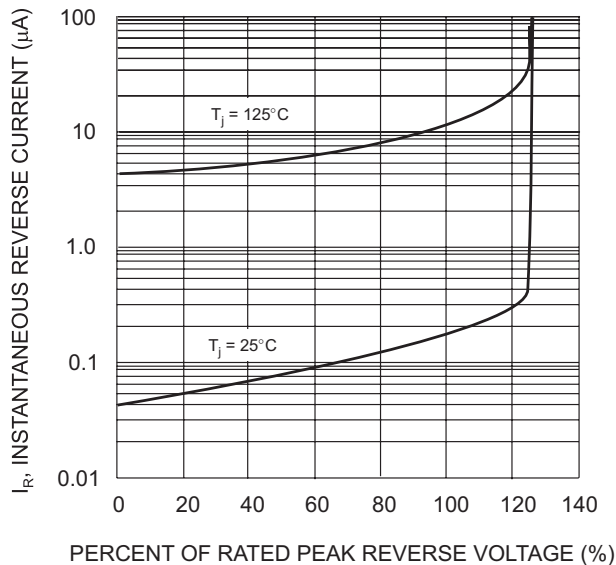

Fig. 5 Typical Reverse Characteristics (per element)



Ordering Information (Note 5)

Device	Packaging	Shipping
RH0x-T	MiniDIP	3000/Tape & Reel

Notes: 5. For Packaging Details, go to our website at <http://www.diodes.com/datasheets/ap02007.pdf>.

Looking for pricing, stock, or lifecycle information?

Click below to explore more details on WIN SOURCE:

-  [View RH06-T on WIN SOURCE](#)
-  [Diodes Incorporated](#) Information

Optimize Your Supply Chain with WIN SOURCE Solutions

-  Global Sourcing Solution
-  Obsolete Management
-  Cost Control Management
-  Shortage Management
-  Alternative Solution
-  Excess Inventory Management