



**THE DATASHEET OF  
IDP20C65D2XKSA1**



## Diode

Rapid Switching Emitter Controlled Diode

## IDP20C65D2

Emitter Controlled Diode Rapid 2 Common Cathode Series

Data sheet

Industrial Power Control

## Rapid Switching Emitter Controlled Diode

### Features:

- Qualified according to JEDEC for target applications
- 650 V Emitter Controlled technology
- Fast recovery
- Soft switching
- Low reverse recovery charge
- Low forward voltage and stable over temperature
- 175 °C junction operating temperature
- Easy paralleling
- Pb-free lead plating; RoHS compliant

### Applications:

- Boost diode in CCM PFC

### Package pin definition:

- Pin 1 - anode (A1)
- Pin 2 and backside - cathode (C)
- Pin 3 - anode (A2)

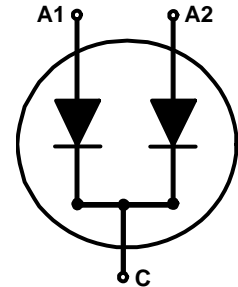

### Key Performance and Package Parameters

Type	$V_{rrm}$	$I_f$	$V_f, T_{vj}=25^{\circ}\text{C}$	$T_{vjmax}$	Marking	Package
IDP20C65D2	650V	2x 10A	1.6V	175°C	C20ED2	PG-TO220-3



**Table of Contents**

Description ..... 2

Table of Contents ..... 3

Maximum Ratings (electrical parameters per diode) ..... 4

Thermal Resistances (per diode) ..... 4

Electrical Characteristics ..... 4

Electrical Characteristics Diagrams ..... 6

Package Drawing ..... 8

Testing Conditions ..... 9

Revision History ..... 10

Disclaimer ..... 10

**Maximum Ratings (electrical parameters per diode)**

For optimum lifetime and reliability, Infineon recommends operating conditions that do not exceed 80% of the maximum ratings stated in this datasheet.

Parameter	Symbol	Value	Unit
Repetitive peak reverse voltage, $T_{vj} \geq 25^{\circ}\text{C}$	$V_{RRM}$	650	V
Diode forward current, limited by $T_{vjmax}$ $T_C = 25^{\circ}\text{C}$ $T_C = 100^{\circ}\text{C}$	$I_F$	20.0 10.0	A
Diode pulsed current, $t_p$ limited by $T_{vjmax}$	$I_{Fpuls}$	30.0	A
Diode surge non repetitive forward current $T_C = 25^{\circ}\text{C}$ , $t_p = 8.3\text{ms}$ , sine halfwave	$I_{FSM}$	60.0	A
Power dissipation $T_C = 25^{\circ}\text{C}$	$P_{tot}$	68.0	W
Operating junction temperature	$T_{vj}$	-40...+175	$^{\circ}\text{C}$
Storage temperature	$T_{stg}$	-55...+150	$^{\circ}\text{C}$
Soldering temperature, wave soldering 1.6 mm (0.063 in.) from case for 10s		260	$^{\circ}\text{C}$
Mounting torque, M3 screw Maximum of mounting processes: 3	$M$	0.6	Nm

**Thermal Resistances (per diode)**

Parameter	Symbol	Conditions	Max. Value	Unit
<b>Characteristic</b>				
Diode thermal resistance, <sup>1)</sup> junction - case	$R_{th(j-c)}$		2.20	K/W
Thermal resistance junction - ambient	$R_{th(j-a)}$		62	K/W

**Electrical Characteristics (per diode), at  $T_{vj} = 25^{\circ}\text{C}$ , unless otherwise specified**

Parameter	Symbol	Conditions	Value			Unit
			min.	typ.	max.	
<b>Static Characteristic</b>						
Diode forward voltage	$V_F$	$I_F = 10.0\text{A}$ $T_{vj} = 25^{\circ}\text{C}$ $T_{vj} = 175^{\circ}\text{C}$	- -	1.60 1.65	2.20 -	V
Reverse leakage current <sup>2)</sup>	$I_R$	$V_R = 650\text{V}$ $T_{vj} = 25^{\circ}\text{C}$ $T_{vj} = 175^{\circ}\text{C}$	- -	4.0 250.0	40.0 -	$\mu\text{A}$

**Electrical Characteristic, at  $T_{vj} = 25^{\circ}\text{C}$ , unless otherwise specified**

Parameter	Symbol	Conditions	Value			Unit
			min.	typ.	max.	
<b>Dynamic Characteristic</b>						
Internal emitter inductance measured 5mm (0.197 in.) from case	$L_E$		-	7.0	-	nH

<sup>1)</sup> Please be aware that in non standard load conditions, due to high  $R_{th(j-c)}$ ,  $T_{vj}$  close to  $T_{vjmax}$  can be reached.

<sup>2)</sup> Reverse leakage current per diode specified for operating conditions with zero voltage applied to the other diode.

**Switching Characteristics (per diode), Inductive Load**

Parameter	Symbol	Conditions	Value			Unit
			min.	typ.	max.	
<b>Diode Characteristic, at <math>T_{vj} = 25^{\circ}\text{C}</math></b>						
Diode reverse recovery time	$t_{rr}$	$T_{vj} = 25^{\circ}\text{C}$ , $V_R = 400\text{V}$ , $I_F = 10.0\text{A}$ , $di_F/dt = 1000\text{A}/\mu\text{s}$ , $L\sigma = 30\text{nH}$ , $C\sigma = 40\text{pF}$ , switch IKW50N65H5	-	28	-	ns
Diode reverse recovery charge	$Q_{rr}$		-	0.16	-	$\mu\text{C}$
Diode peak reverse recovery current	$I_{rrm}$		-	8.6	-	A
Diode peak rate of fall of reverse recovery current during $t_b$	$di_{rr}/dt$		-	-740	-	$\text{A}/\mu\text{s}$
Diode reverse recovery time	$t_{rr}$	$T_{vj} = 25^{\circ}\text{C}$ , $V_R = 400\text{V}$ , $I_F = 10.0\text{A}$ , $di_F/dt = 350\text{A}/\mu\text{s}$ , $L\sigma = 30\text{nH}$ , $C\sigma = 40\text{pF}$ , switch IKW50N65H5	-	50	-	ns
Diode reverse recovery charge	$Q_{rr}$		-	0.13	-	$\mu\text{C}$
Diode peak reverse recovery current	$I_{rrm}$		-	4.3	-	A
Diode peak rate of fall of reverse recovery current during $t_b$	$di_{rr}/dt$		-	-130	-	$\text{A}/\mu\text{s}$

**Switching Characteristics (per diode), Inductive Load**

Parameter	Symbol	Conditions	Value			Unit
			min.	typ.	max.	
<b>Diode Characteristic, at <math>T_{vj} = 175^{\circ}\text{C}/125^{\circ}\text{C}</math></b>						
Diode reverse recovery time	$t_{rr}$	$T_{vj} = 175^{\circ}\text{C}$ , $V_R = 400\text{V}$ , $I_F = 10.0\text{A}$ , $di_F/dt = 1000\text{A}/\mu\text{s}$ , $L\sigma = 30\text{nH}$ , $C\sigma = 40\text{pF}$ , switch IKW50N65H5	-	35	-	ns
Diode reverse recovery charge	$Q_{rr}$		-	0.23	-	$\mu\text{C}$
Diode peak reverse recovery current	$I_{rrm}$		-	11.3	-	A
Diode peak rate of fall of reverse recovery current during $t_b$	$di_{rr}/dt$		-	-730	-	$\text{A}/\mu\text{s}$
Diode reverse recovery time	$t_{rr}$	$T_{vj} = 125^{\circ}\text{C}$ , $V_R = 400\text{V}$ , $I_F = 10.0\text{A}$ , $di_F/dt = 350\text{A}/\mu\text{s}$ , $L\sigma = 30\text{nH}$ , $C\sigma = 40\text{pF}$ , switch IKW50N65H5	-	54	-	ns
Diode reverse recovery charge	$Q_{rr}$		-	0.18	-	$\mu\text{C}$
Diode peak reverse recovery current	$I_{rrm}$		-	5.0	-	A
Diode peak rate of fall of reverse recovery current during $t_b$	$di_{rr}/dt$		-	-190	-	$\text{A}/\mu\text{s}$

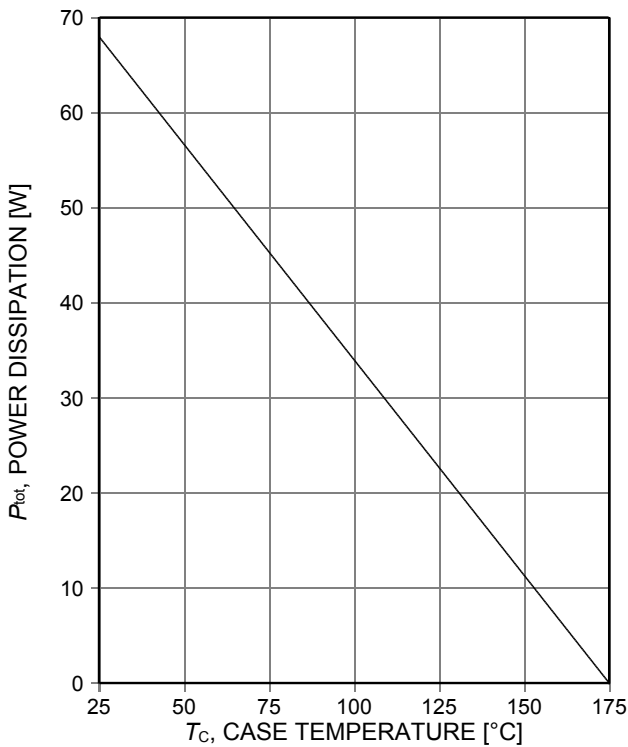

Figure 1. Power dissipation per diode as a function of case temperature ( $T_{vj} \leq 175^\circ\text{C}$ )

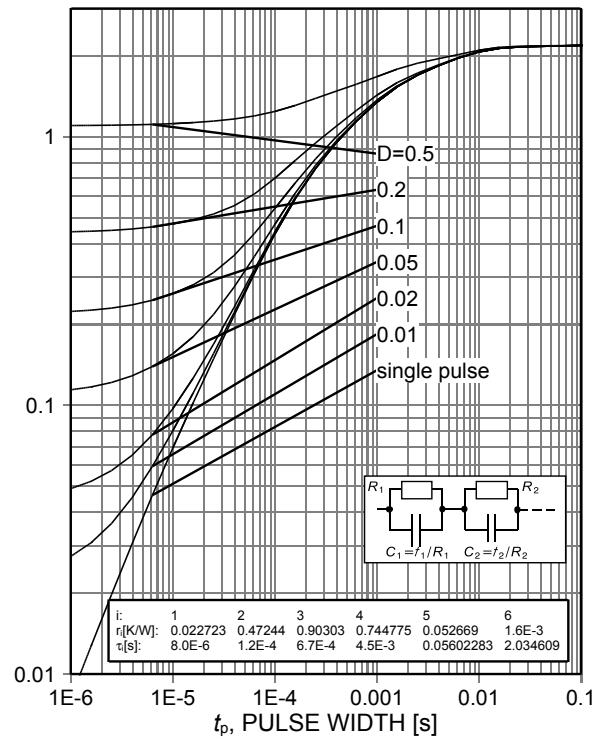

Figure 2. Diode transient thermal impedance per diode as a function of pulse width ( $D = t_p/T$ )

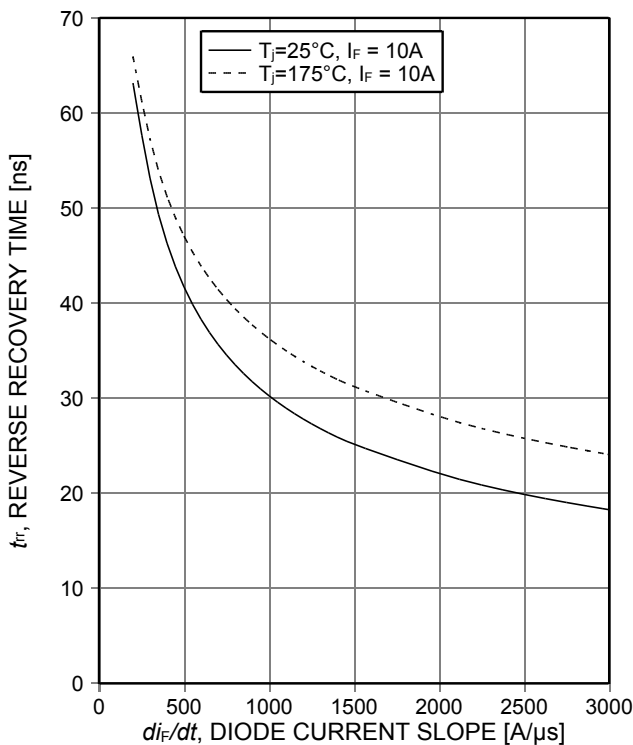

Figure 3. Typical reverse recovery time as a function of diode current slope ( $V_R = 400\text{V}$ )

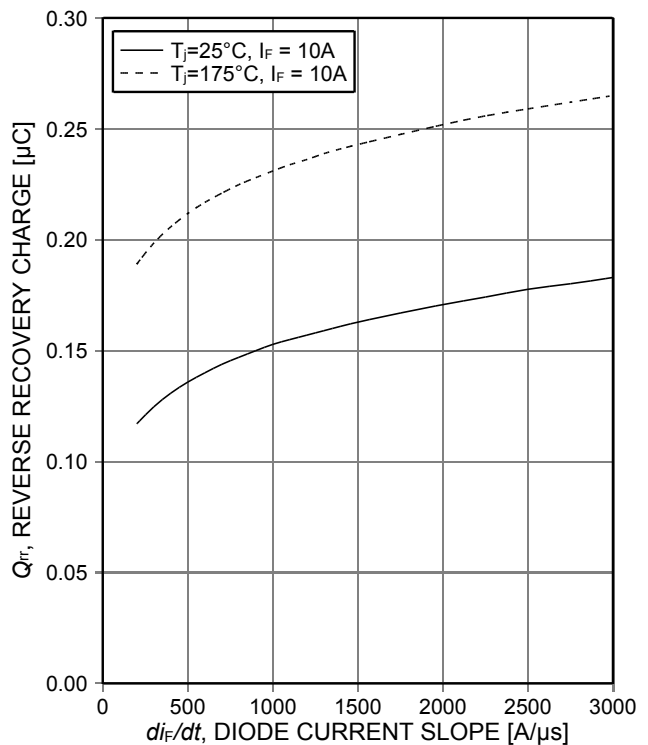

Figure 4. Typical reverse recovery charge per diode as a function of diode current slope ( $V_R = 400\text{V}$ )

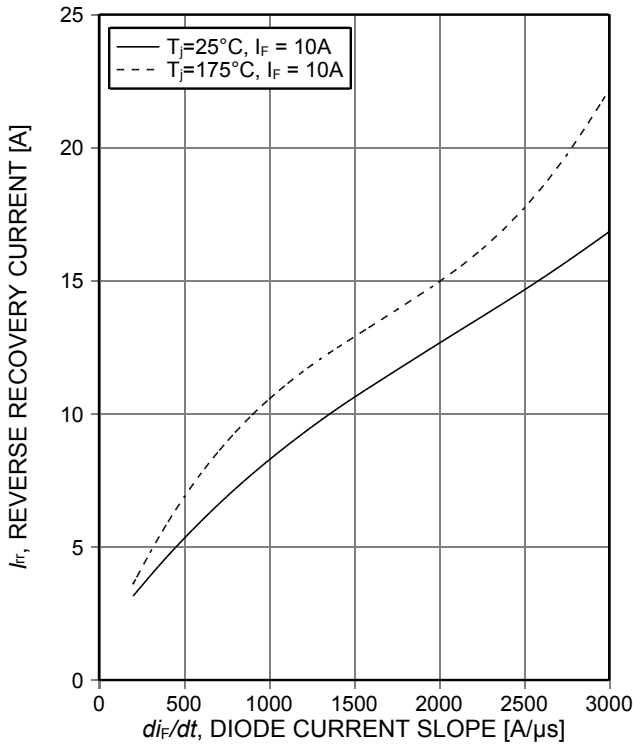

Figure 5. Typical reverse recovery current per diode as a function of diode current slope ( $V_R=400V$ )

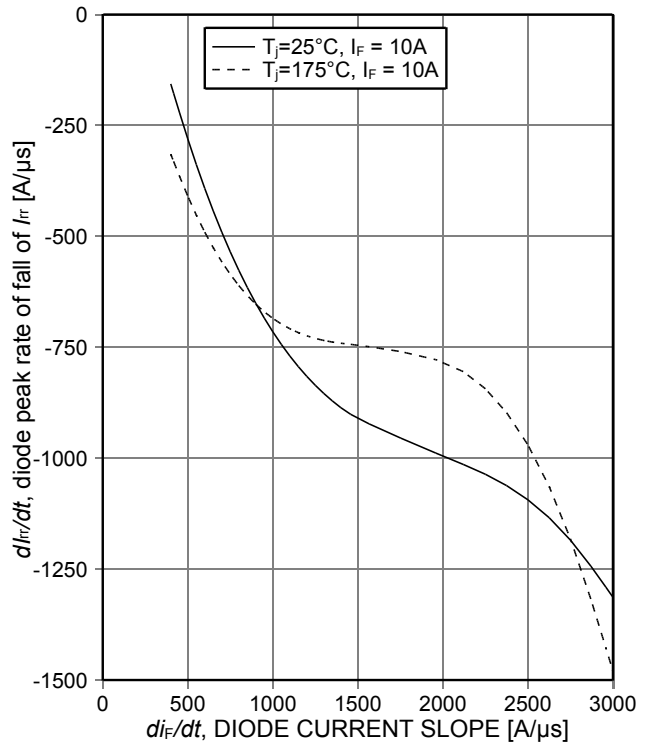

Figure 6. Typical diode peak rate of fall of rev. rec. current per diode as a function of diode current slope ( $V_R=400V$ )

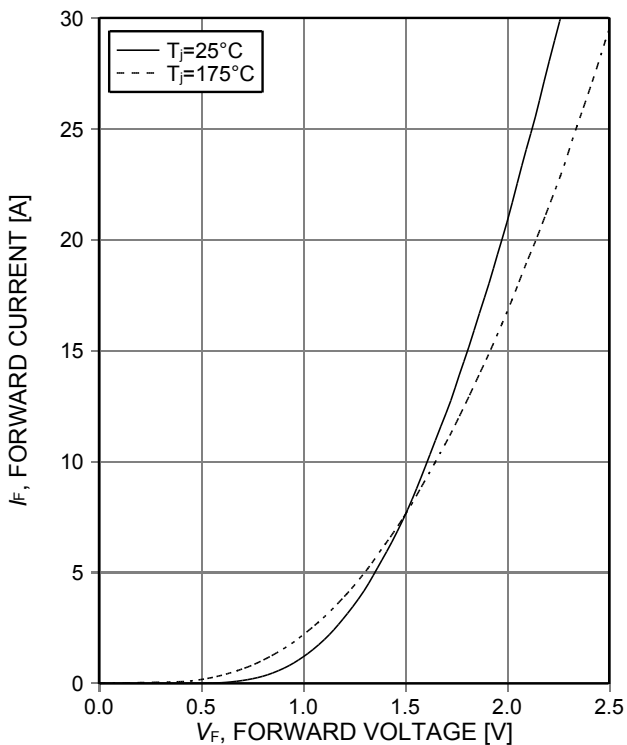

Figure 7. Typical diode forward current per diode as a function of forward voltage

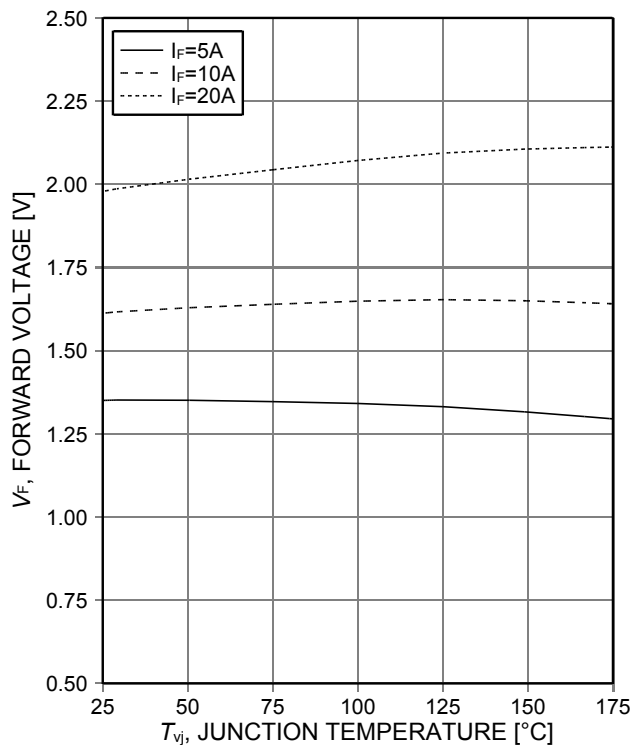
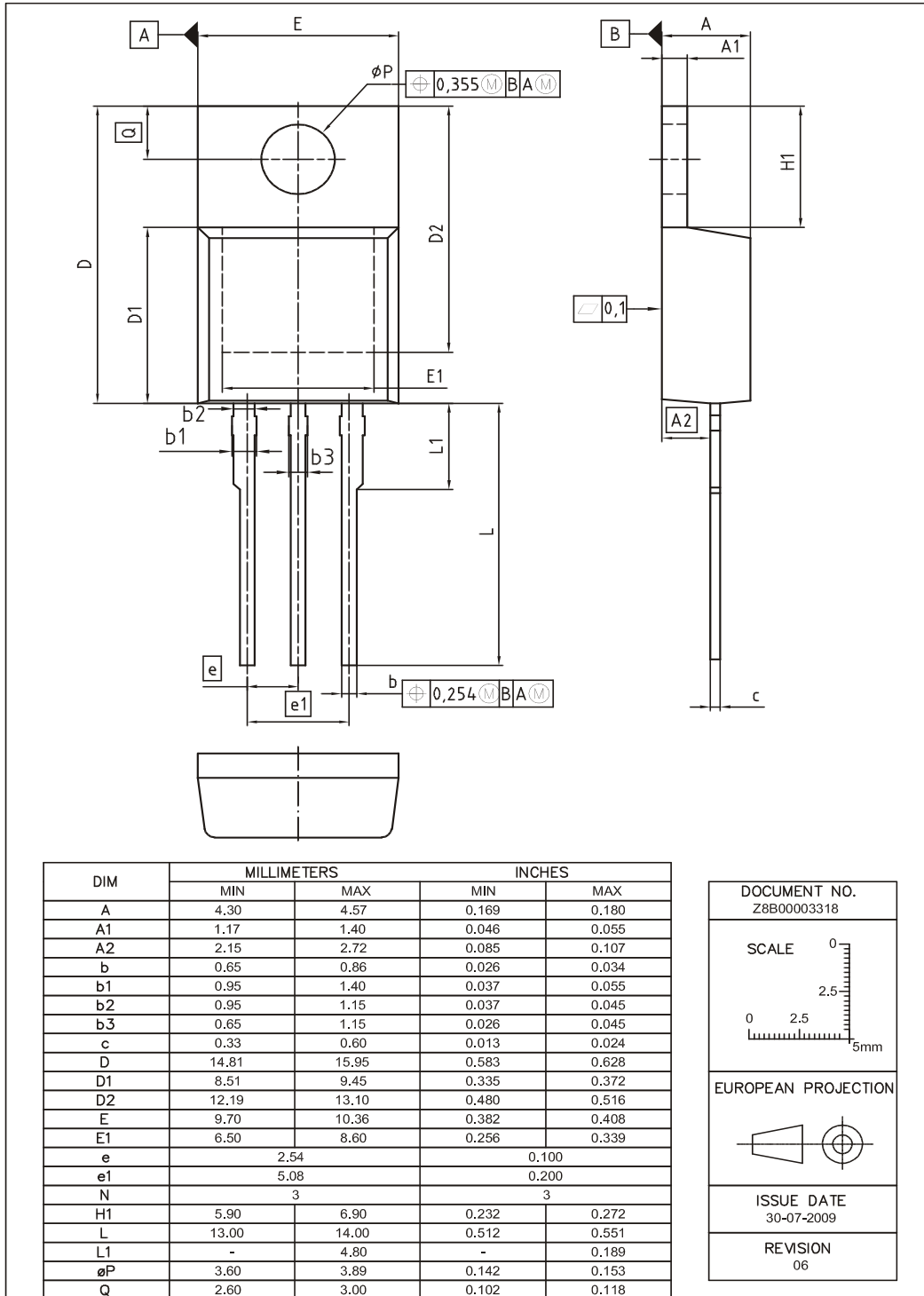

Figure 8. Typical diode forward voltage as a function of junction temperature

PG-TO220-3



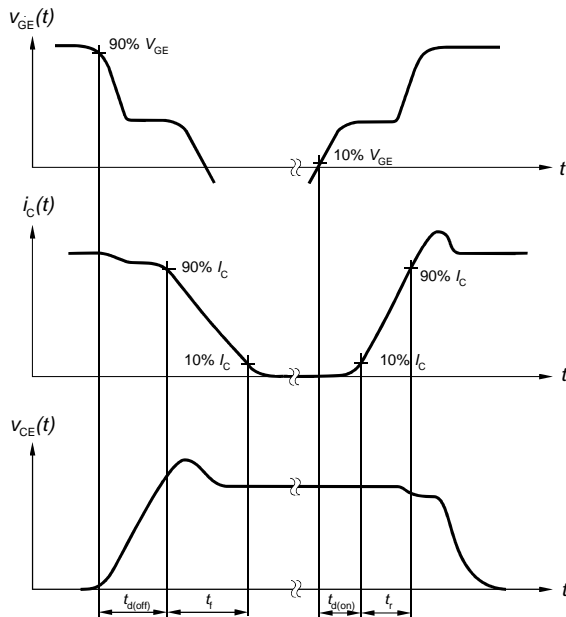

Figure A. Definition of switching times

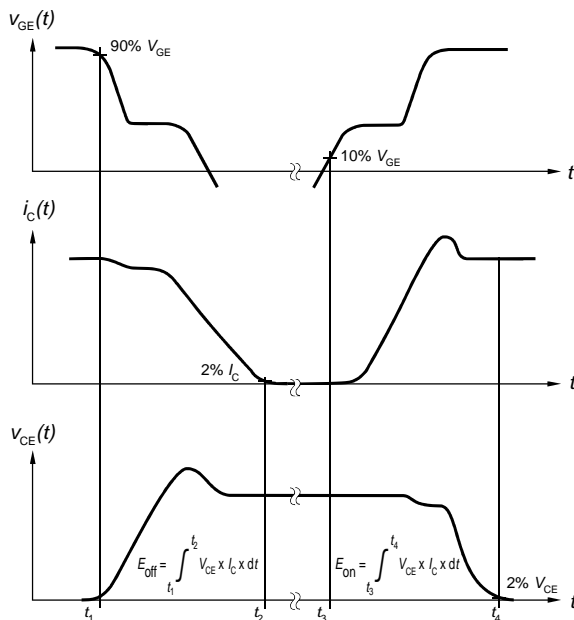

Figure B. Definition of switching losses

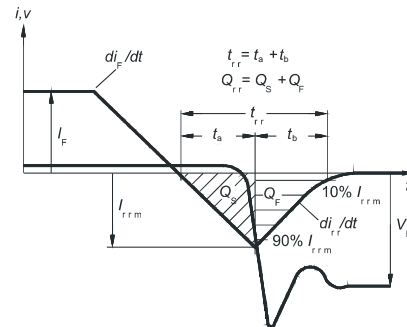

Figure C. Definition of diodes switching characteristics

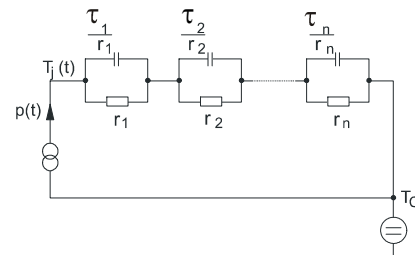

Figure D. Thermal equivalent circuit

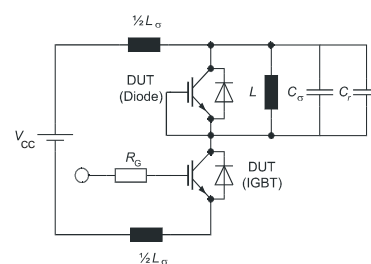

Figure E. Dynamic test circuit  
Parasitic inductance  $L_\sigma$ ,  
Parasitic capacitor  $C_\sigma$ ,  
Relief capacitor  $C_r$   
(only for ZVT switching)

## Revision History

---

IDP20C65D2

Revision: 2014-09-18, Rev. 2.1

---

Previous Revision

Revision	Date	Subjects (major changes since last revision)
2.1	2014-09-18	Final data sheet

## We Listen to Your Comments

Any information within this document that you feel is wrong, unclear or missing at all ?

Your feedback will help us to continuously improve the quality of this document.

Please send your proposal (including a reference to this document) to: [erratum@infineon.com](mailto:erratum@infineon.com)

## Published by

Infineon Technologies AG

81726 Munich, Germany

81726 München, Germany

© 2014 Infineon Technologies AG

All Rights Reserved.

## Legal Disclaimer

The information given in this document shall in no event be regarded as a guarantee of conditions or characteristics.

With respect to any examples or hints given herein, any typical values stated herein and/or any information regarding the application of the device, Infineon Technologies hereby disclaims any and all warranties and liabilities of any kind, including without limitation, warranties of non-infringement of intellectual property rights of any third party.

## Information

For further information on technology, delivery terms and conditions and prices, please contact the nearest Infineon Technologies Office ([www.infineon.com](http://www.infineon.com)).



## Warnings

Due to technical requirements, components may contain dangerous substances. For information on the types in question, please contact the nearest Infineon Technologies Office.

The Infineon Technologies component described in this Data Sheet may be used in life-support devices or systems and/or automotive, aviation and aerospace applications or systems only with the express written approval of Infineon Technologies, if a failure of such components can reasonably be expected to cause the failure of that life-support, automotive, aviation and aerospace device or system or to affect the safety or effectiveness of that device or system. Life support devices or systems are intended to be implanted in the human body or to support and/or maintain and sustain and/or protect human life. If they fail, it is reasonable to assume that the health of the user or other persons may be endangered.

## Looking for pricing, stock, or lifecycle information?

Click below to explore more details on WIN SOURCE:

-  [View IDP20C65D2XKSA1 on WIN SOURCE](#)
-  [Infineon Technologies Information](#)

## Optimize Your Supply Chain with WIN SOURCE Solutions

-  Global Sourcing Solution
-  Obsolete Management
-  Cost Control Management
-  Shortage Management
-  Alternative Solution
-  Excess Inventory Management