



**THE DATASHEET OF  
APT200GN60JDQ4**



Utilizing the latest Field Stop and Trench Gate technologies, these IGBT's have ultra low  $V_{CE(ON)}$  and are ideal for low frequency applications that require absolute minimum conduction loss. Easy paralleling is a result of very tight parameter distribution and a slightly positive  $V_{CE(ON)}$  temperature coefficient. A built-in gate resistor ensures extremely reliable operation, even in the event of a short circuit fault. Low gate charge simplifies gate drive design and minimizes losses

- 600V Field Stop
- Trench Gate: Low  $V_{CE(on)}$
- Easy Paralleling
- 5 $\mu$ s Short Circuit Capability
- Intergrated Gate Resistor: Low EMI, High Reliability
- 175°C Rated

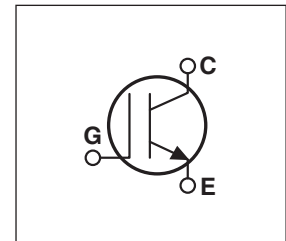
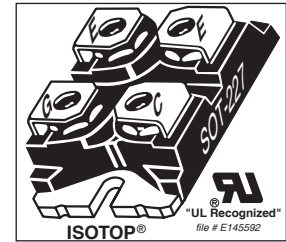

**Applications:** welding, inductive heating, solar inverters, motor drives, UPS, pass transistor

### MAXIMUM RATINGS

All Ratings:  $T_C = 25^\circ\text{C}$  unless otherwise specified.

Symbol	Parameter	APT200GN60J	UNIT
$V_{CES}$	Collector-Emitter Voltage	600	Volts
$V_{GE}$	Gate-Emitter Voltage	$\pm 20$	
$I_{C1}$	Continuous Collector Current @ $T_C = 25^\circ\text{C}$	283	Amps
$I_{C2}$	Continuous Collector Current @ $T_C = 110^\circ\text{C}$	158	
$I_{CM}$	Pulsed Collector Current <sup>①</sup>	600	
SSOA	Switching Safe Operating Area @ $T_J = 175^\circ\text{C}$	600A @ 600V	
$P_D$	Total Power Dissipation	682	Watts
$T_J, T_{STG}$	Operating and Storage Junction Temperature Range	-55 to 175	$^\circ\text{C}$

### STATIC ELECTRICAL CHARACTERISTICS

Symbol	Characteristic / Test Conditions	MIN	TYP	MAX	UNIT
$V_{(BR)CES}$	Collector-Emitter Breakdown Voltage ( $V_{GE} = 0\text{V}, I_C = 4\text{mA}$ )	600			Volts
$V_{GE(TH)}$	Gate Threshold Voltage ( $V_{CE} = V_{GE}, I_C = 3.2\text{mA}, T_J = 25^\circ\text{C}$ )	5	5.8	6.5	
$V_{CE(ON)}$	Collector-Emitter On Voltage ( $V_{GE} = 15\text{V}, I_C = 200\text{A}, T_J = 25^\circ\text{C}$ )	1.05	1.45	1.85	
	Collector-Emitter On Voltage ( $V_{GE} = 15\text{V}, I_C = 200\text{A}, T_J = 125^\circ\text{C}$ )		1.65		
	Collector-Emitter On Voltage ( $V_{GE} = 15\text{V}, I_C = 100\text{A}, T_J = 25^\circ\text{C}$ )		1.15		
	Collector-Emitter On Voltage ( $V_{GE} = 15\text{V}, I_C = 100\text{A}, T_J = 125^\circ\text{C}$ )		1.19		
$I_{CES}$	Collector Cut-off Current ( $V_{CE} = 600\text{V}, V_{GE} = 0\text{V}, T_J = 25^\circ\text{C}$ ) <sup>②</sup>			25	$\mu\text{A}$
	Collector Cut-off Current ( $V_{CE} = 600\text{V}, V_{GE} = 0\text{V}, T_J = 125^\circ\text{C}$ ) <sup>②</sup>			TBD	
$I_{GES}$	Gate-Emitter Leakage Current ( $V_{GE} = \pm 20\text{V}$ )			600	nA
$R_{GINT}$	Intergrated Gate Resistor		2		$\Omega$

 **CAUTION:** These Devices are Sensitive to Electrostatic Discharge. Proper Handling Procedures Should Be Followed.

APT Website - <http://www.advancedpower.com>

**DYNAMIC CHARACTERISTICS**

**APT200GN60J**

Symbol	Characteristic	Test Conditions	MIN	TYP	MAX	UNIT
C <sub>ies</sub>	Input Capacitance	<b>Capacitance</b> V <sub>GE</sub> = 0V, V <sub>CE</sub> = 25V f = 1 MHz		14100		pF
C <sub>oes</sub>	Output Capacitance			4610		
C <sub>res</sub>	Reverse Transfer Capacitance			4000		
V <sub>GEP</sub>	Gate-to-Emitter Plateau Voltage	Gate Charge		8.2		V
Q <sub>g</sub>	Total Gate Charge <sup>③</sup>	V <sub>GE</sub> = 15V		1180		nC
Q <sub>ge</sub>	Gate-Emitter Charge	V <sub>CE</sub> = 300V		85		
Q <sub>gc</sub>	Gate-Collector ("Miller") Charge	I <sub>C</sub> = 100A		660		
SSOA	Switching Safe Operating Area	T <sub>J</sub> = 175°C, R <sub>G</sub> = 1.0Ω <sup>⑦</sup> , V <sub>GE</sub> = 15V, L = 100μH, V <sub>CE</sub> = 600V	600			A
SCSOA	Short Circuit Safe Operating Area	V <sub>CC</sub> = 360V, V <sub>GE</sub> = 15V, T <sub>J</sub> = 150°C, R <sub>G</sub> = 1.0Ω <sup>⑦</sup>	5			μs
t <sub>d(on)</sub>	Turn-on Delay Time	<b>Inductive Switching (25°C)</b>  V <sub>CC</sub> = 400V V <sub>GE</sub> = 15V I <sub>C</sub> = 200A R <sub>G</sub> = 1.0Ω <sup>⑦</sup> T <sub>J</sub> = +25°C		50		ns
t <sub>r</sub>	Current Rise Time			80		
t <sub>d(off)</sub>	Turn-off Delay Time			560		
t <sub>f</sub>	Current Fall Time			100		mJ
E <sub>on1</sub>	Turn-on Switching Energy <sup>④</sup>			13		
E <sub>on2</sub>	Turn-on Switching Energy (Diode) <sup>⑤</sup>			15		
E <sub>off</sub>	Turn-off Switching Energy <sup>⑥</sup>		11			
t <sub>d(on)</sub>	Turn-on Delay Time	<b>Inductive Switching (125°C)</b>  V <sub>CC</sub> = 400V V <sub>GE</sub> = 15V I <sub>C</sub> = 200A R <sub>G</sub> = 1.0Ω <sup>⑦</sup> T <sub>J</sub> = +125°C		50		ns
t <sub>r</sub>	Current Rise Time			80		
t <sub>d(off)</sub>	Turn-off Delay Time			620		
t <sub>f</sub>	Current Fall Time			70		mJ
E <sub>on1</sub>	Turn-on Switching Energy <sup>④</sup>			14		
E <sub>on2</sub>	Turn-on Switching Energy (Diode) <sup>⑤</sup>			16		
E <sub>off</sub>	Turn-off Switching Energy <sup>⑥</sup>		10			

**THERMAL AND MECHANICAL CHARACTERISTICS**

Symbol	Characteristic	MIN	TYP	MAX	UNIT
R <sub>θJC</sub>	Junction to Case ( <b>IGBT</b> )			.22	°C/W
R <sub>θJC</sub>	Junction to Case ( <b>DIODE</b> )			N/A	
V <sub>Isolation</sub>	RMS Voltage (50-60Hz Sinusoidal Waveform from Terminals to Mounting Base for 1 Min.)	2500			Volts
W <sub>T</sub>	Package Weight		1.03		oz
			29.2		gm
Torque	Maximum Terminal & Mounting Torque			10	lb•in
				1.1	N•m

- ① Repetitive Rating: Pulse width limited by maximum junction temperature.
- ② For Combi devices, I<sub>ces</sub> includes both IGBT and FRED leakages
- ③ See MIL-STD-750 Method 3471.
- ④ E<sub>on1</sub> is the clamped inductive turn-on energy of the IGBT only, without the effect of a commutating diode reverse recovery current adding to the IGBT turn-on loss. Tested in inductive switching test circuit shown in figure 21, but with a Silicon Carbide diode.
- ⑤ E<sub>on2</sub> is the clamped inductive turn-on energy that includes a commutating diode reverse recovery current in the IGBT turn-on switching loss. (See Figures 21, 22.)
- ⑥ E<sub>off</sub> is the clamped inductive turn-off energy measured in accordance with JEDEC standard JESD24-1. (See Figures 21, 23.)
- ⑦ R<sub>G</sub> is external gate resistance, not including R<sub>G(int)</sub> nor gate driver impedance. (MIC4452)

**APT Reserves the right to change, without notice, the specifications and information contained herein.**

**TYPICAL PERFORMANCE CURVES**

**APT200GN60J**

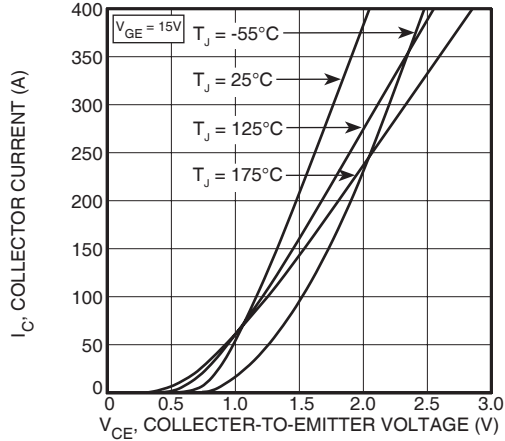

**FIGURE 1, Output Characteristics ( $T_J = 25^\circ\text{C}$ )**

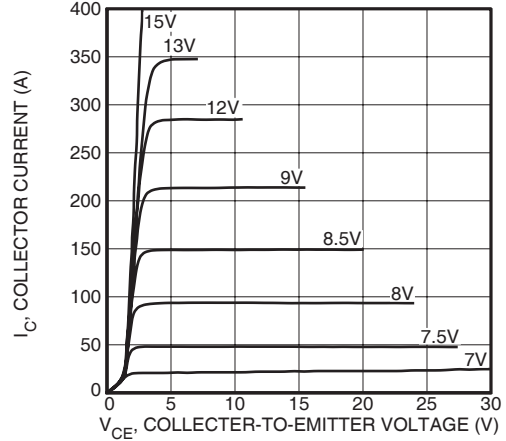

**FIGURE 2, Output Characteristics ( $T_J = 125^\circ\text{C}$ )**

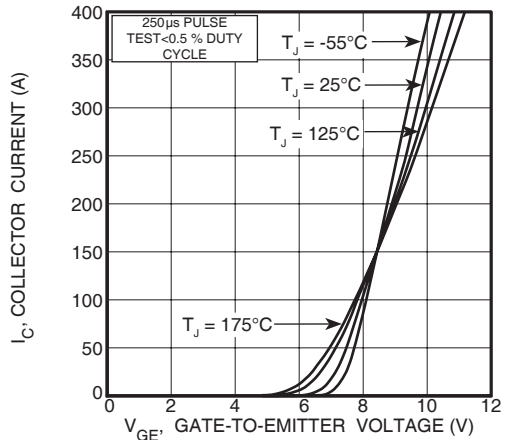

**FIGURE 3, Transfer Characteristics**

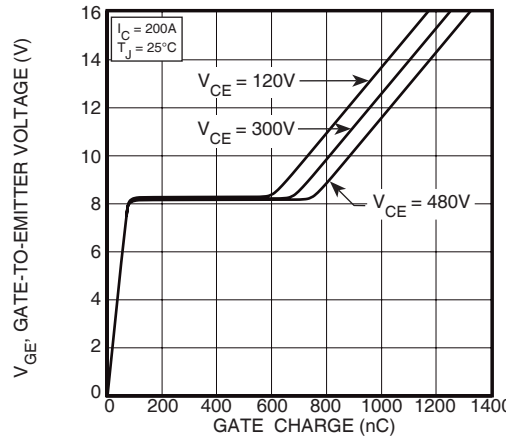

**FIGURE 4, Gate Charge**

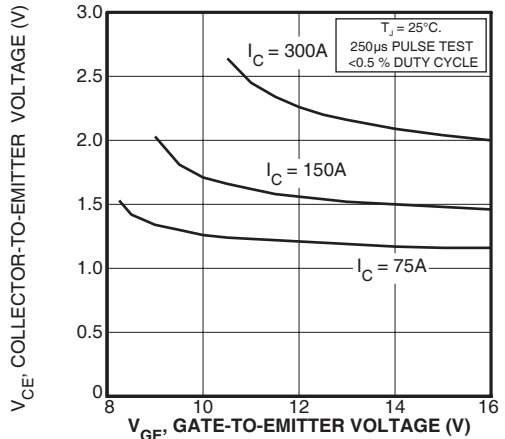

**FIGURE 5, On State Voltage vs Gate-to-Emitter Voltage**

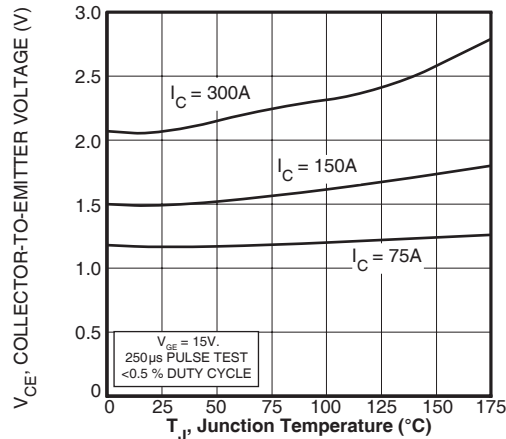

**FIGURE 6, On State Voltage vs Junction Temperature**

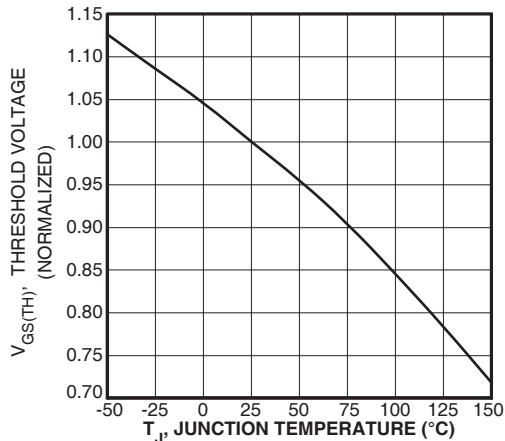

**FIGURE 7, Threshold Voltage vs. Junction Temperature**

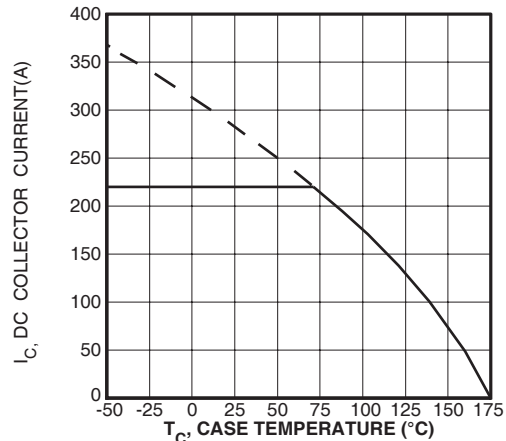

**FIGURE 8, DC Collector Current vs Case Temperature**

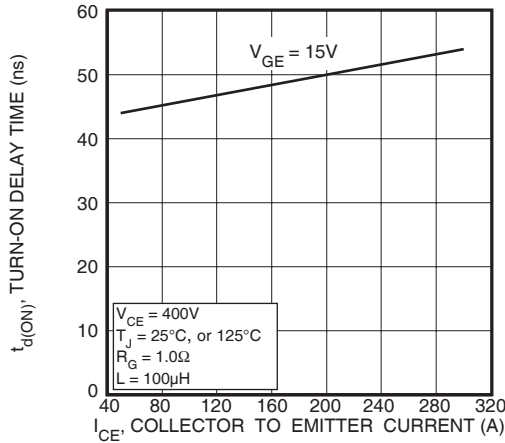

FIGURE 9, Turn-On Delay Time vs Collector Current

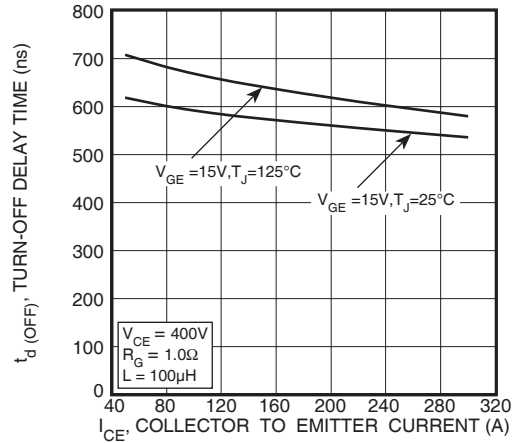

FIGURE 10, Turn-Off Delay Time vs Collector Current

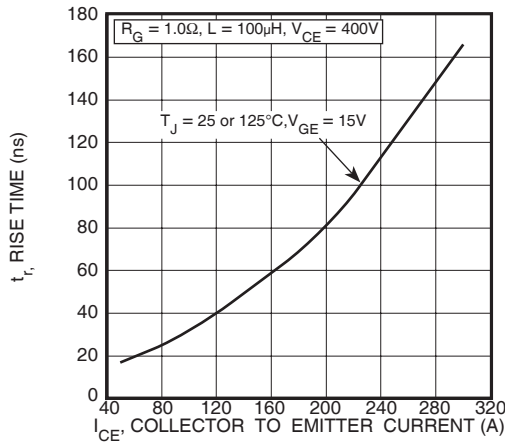

FIGURE 11, Current Rise Time vs Collector Current

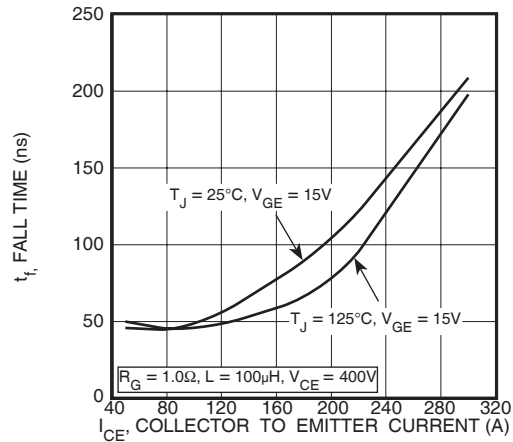

FIGURE 12, Current Fall Time vs Collector Current

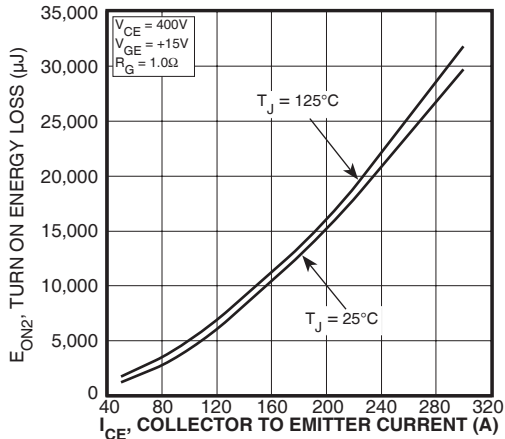

FIGURE 13, Turn-On Energy Loss vs Collector Current

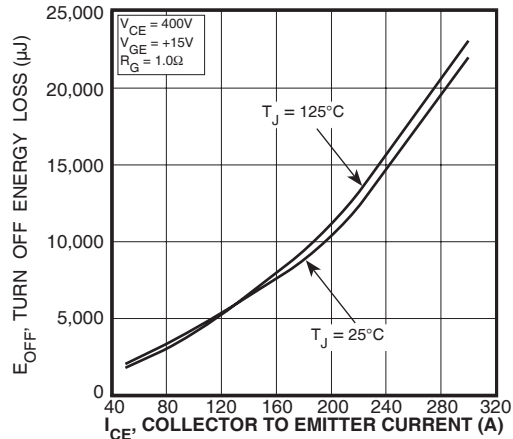

FIGURE 14, Turn Off Energy Loss vs Collector Current

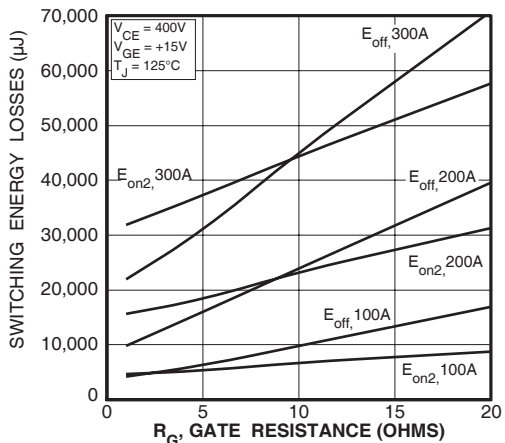

FIGURE 15, Switching Energy Losses vs. Gate Resistance

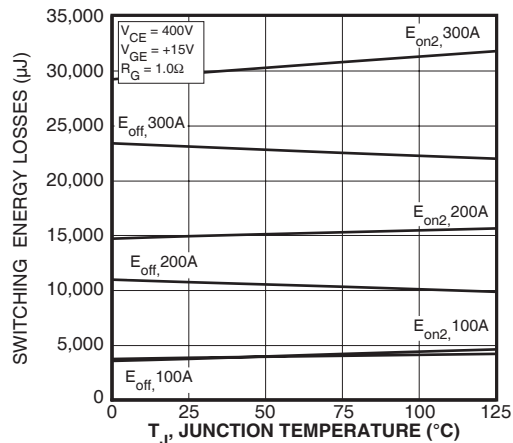

FIGURE 16, Switching Energy Losses vs Junction Temperature

### TYPICAL PERFORMANCE CURVES

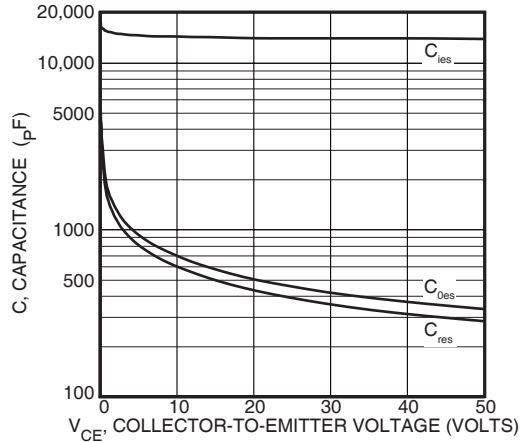

Figure 17, Capacitance vs Collector-To-Emitter Voltage

### APT200GN60J

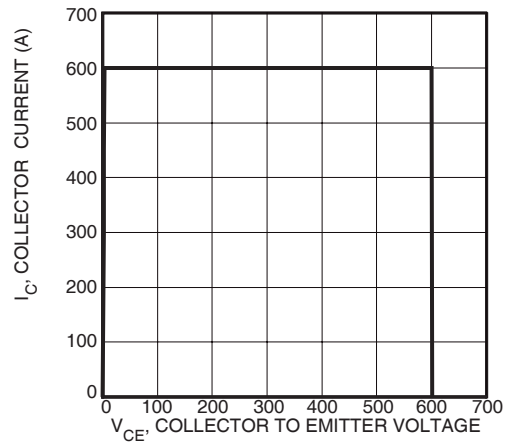

Figure 18, Minimum Switching Safe Operating Area

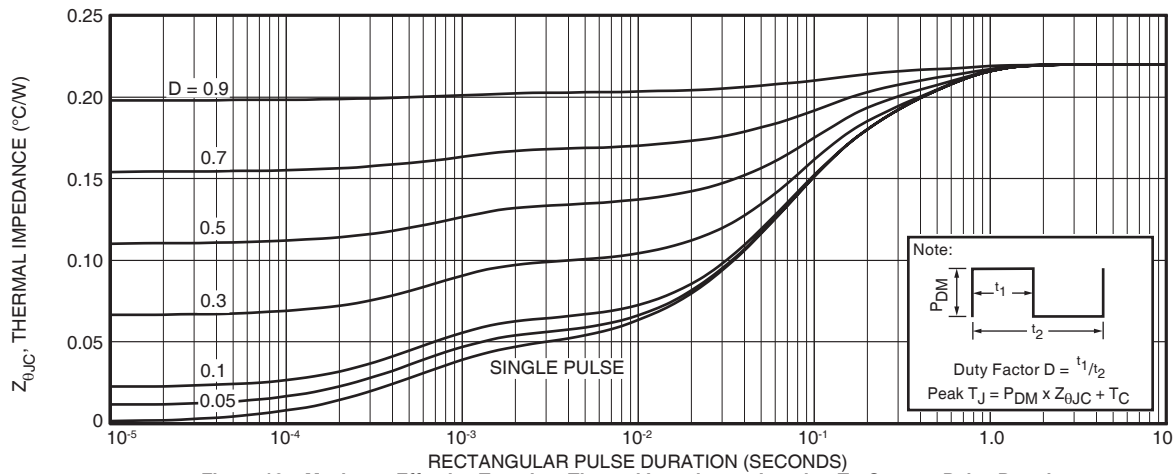

Figure 19a, Maximum Effective Transient Thermal Impedance, Junction-To-Case vs Pulse Duration

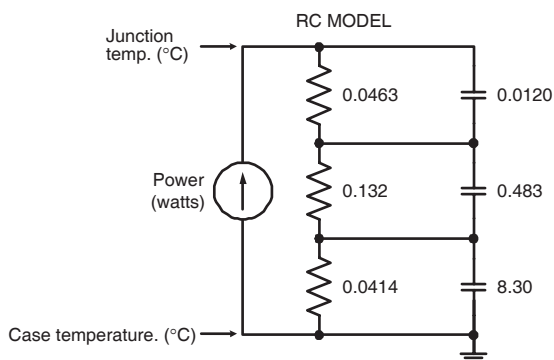

FIGURE 19b, TRANSIENT THERMAL IMPEDANCE MODEL

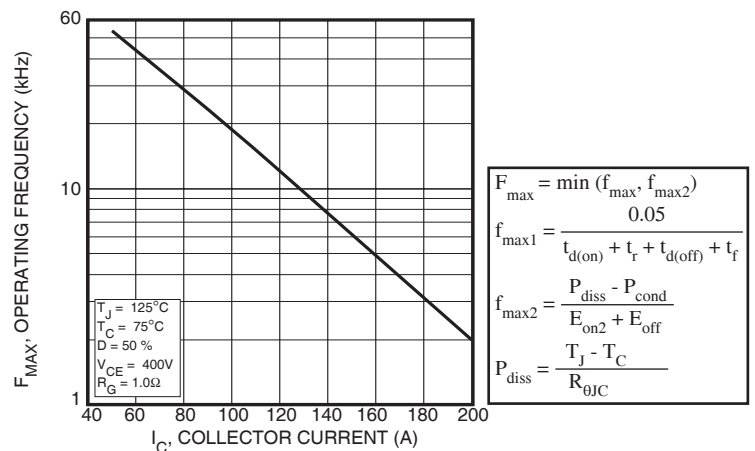

Figure 20, Operating Frequency vs Collector Current

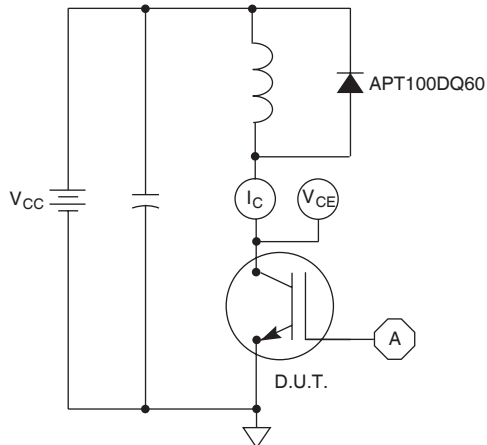

Figure 21, Inductive Switching Test Circuit

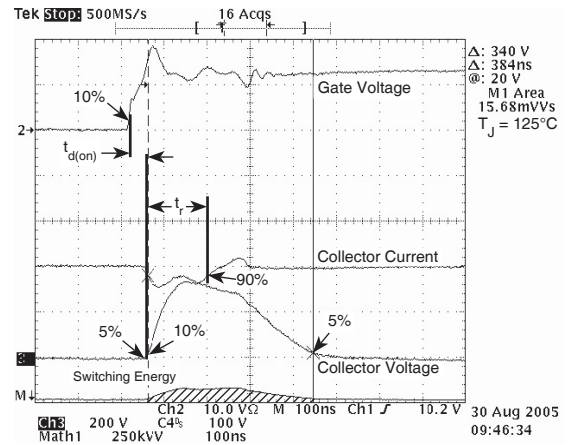

Figure 22, Turn-on Switching Waveforms and Definitions

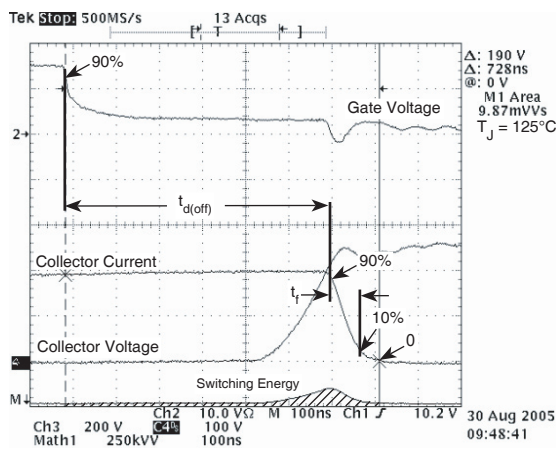
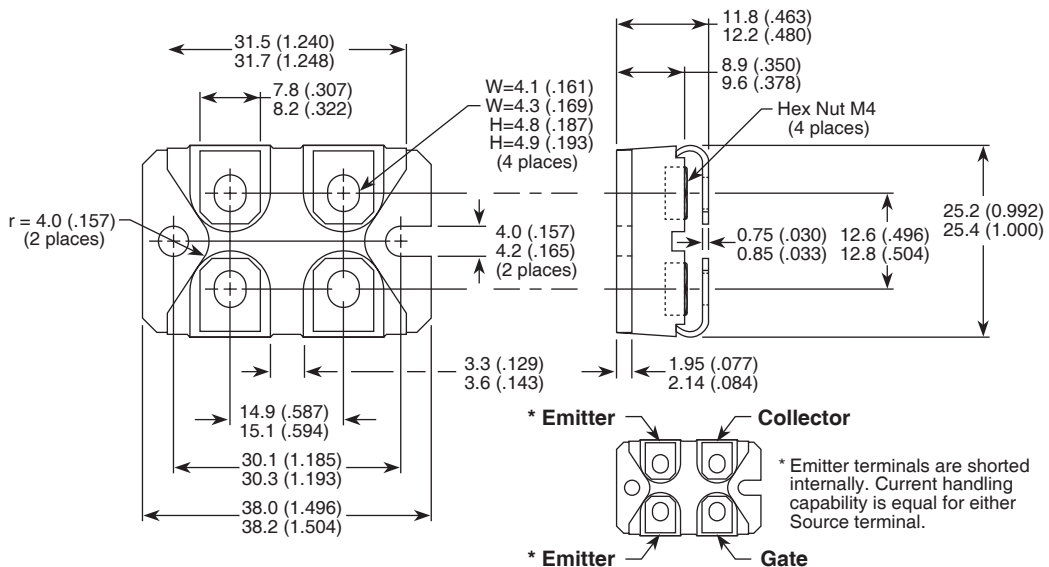

Figure 23, Turn-off Switching Waveforms and Definitions

SOT-227 (ISOTOP®) Package Outline



Dimensions in Millimeters and (Inches)

## Looking for pricing, stock, or lifecycle information?

Click below to explore more details on WIN SOURCE:

- ⊖ [View APT200GN60JDQ4 on WIN SOURCE](#)
- ⊖ [Microchip Technology Information](#)

## Optimize Your Supply Chain with WIN SOURCE Solutions

- ✓ Global Sourcing Solution
- ✓ Obsolete Management
- ✓ Cost Control Management
- ✓ Shortage Management
- ✓ Alternative Solution
- ✓ Excess Inventory Management