



**THE DATASHEET OF
CDBK0520L-HF**



CDBK0520L-HF

$I_o = 500 \text{ mA}$
 $V_R = 20 \text{ Volts}$
 RoHS Device
 Halogen free

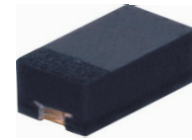

Features

- Low forward voltage.
- Designed for mounting on small surface.
- Extremely thin / leadless package.
- Majority carrier conduction.

Mechanical data

- Case: SOD-123F standard package, molded plastic.
- Terminals: Gold plated, solderable per MIL-STD-750, method 2026.
- Marking code: cathode band & BM
- Mounting position: Any
- Weight: 0.011 gram(approx.).

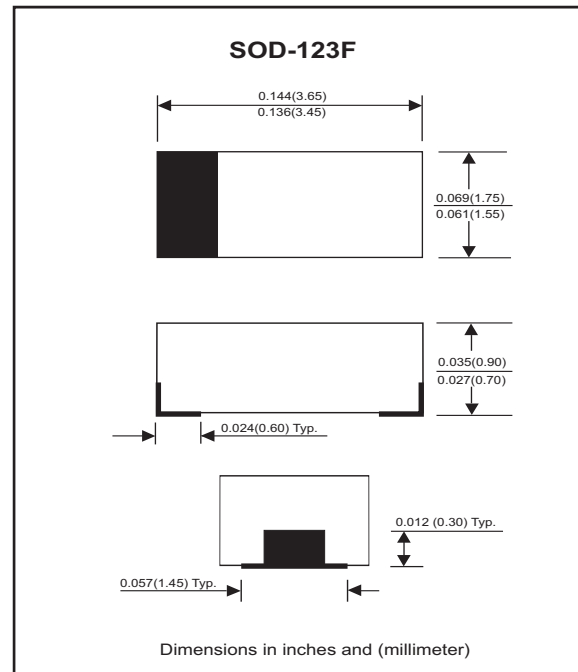

Maximum Rating (at $T_A=25 \text{ }^\circ\text{C}$ unless otherwise noted)

Parameter	Conditions	Symbol	Min	Typ	Max	Unit
Peak reverse voltage		V_{RM}			20	V
Reverse voltage		V_R			20	V
Average forward rectified current		I_o			0.5	A
Forward current, surge peak	8.3 ms single half sine-wave superimposed on rate load (JEDEC method)	I_{FSM}			5.5	A
Storage temperature		T_{STG}	-40		+125	$^\circ\text{C}$
Junction temperature		T_j			+125	$^\circ\text{C}$

Electrical Characteristics (at $T_A=25 \text{ }^\circ\text{C}$ unless otherwise noted)

Parameter	Conditions	Symbol	Min	Typ	Max	Unit
Forward voltage	$I_F = 100\text{mA} @ T_a = 25 \text{ }^\circ\text{C}$ $I_F = 500\text{mA} @ T_a = 25 \text{ }^\circ\text{C}$ $I_F = 100\text{mA} @ T_a = 100 \text{ }^\circ\text{C}$ $I_F = 500\text{mA} @ T_a = 100 \text{ }^\circ\text{C}$	V_F			300 385 220 330	mV
Reverse current	$V_R = 10\text{V} @ T_a = 25 \text{ }^\circ\text{C}$ $V_R = 20\text{V} @ T_a = 25 \text{ }^\circ\text{C}$	I_R			75 250	μA
Capacitance between terminals	$f = 1 \text{ MHz}$, and 0 VDC reverse voltage	C_T			170	pF
Reverse recovery time	$I_F = I_R = 10\text{mA}$, $I_{rr} \times I_R$, $R_L = 100\text{ohm}$	T_{rr}		22		ns

RATING AND CHARACTERISTIC CURVES (CDBK0520L-HF)

Fig. 1 - Forward characteristics

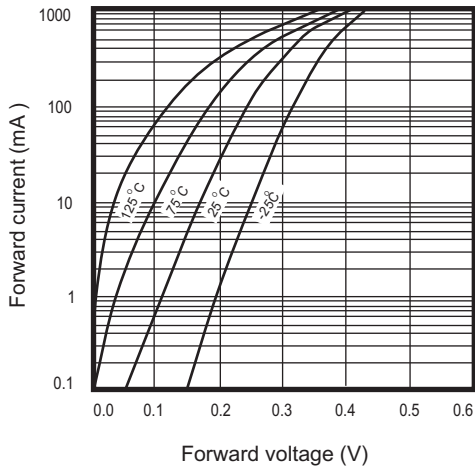

Fig. 2 - Reverse characteristics

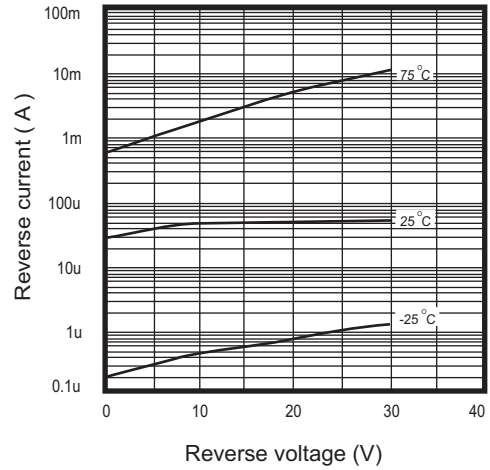

Fig. 3 - Capacitance between terminals characteristics

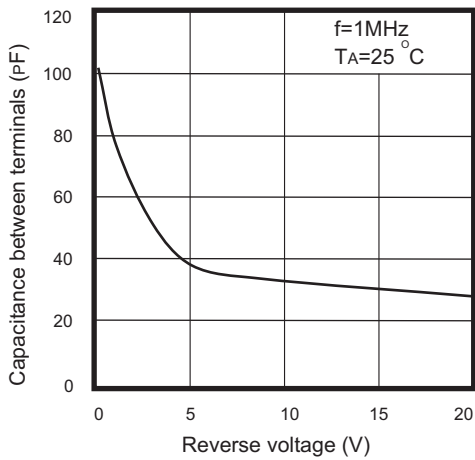
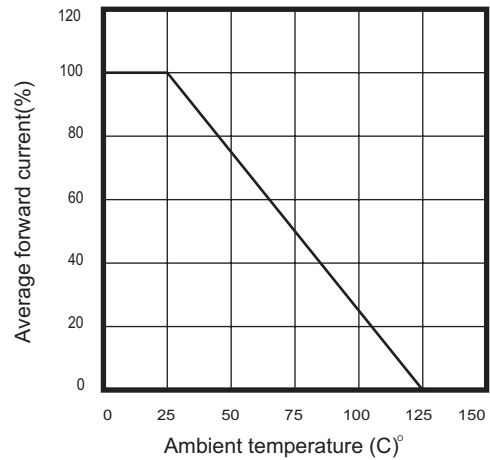
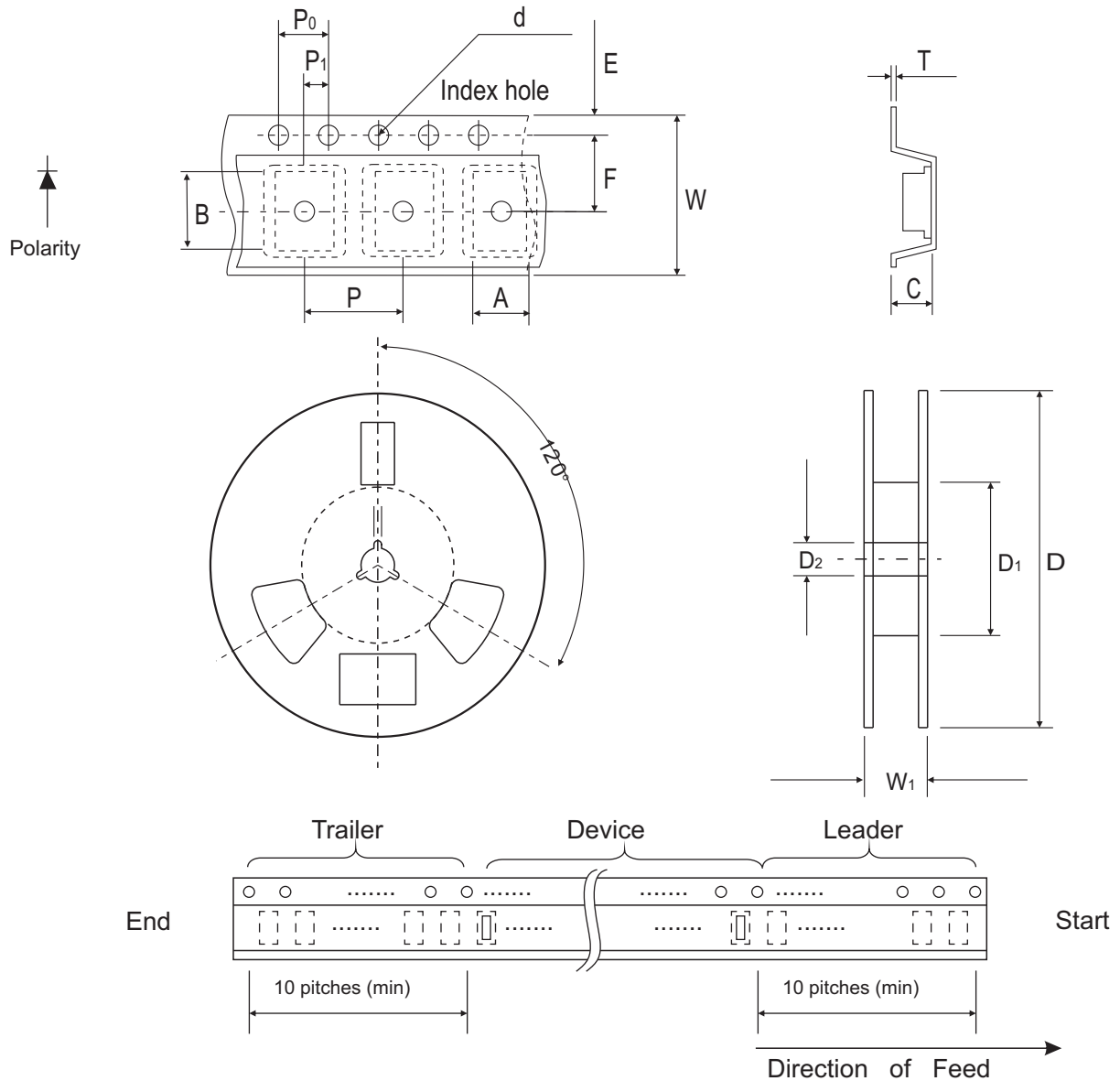

Fig.4 - Current derating curve



Reel Taping Specification



SOD-123F	SYMBOL	A	B	C	d	D	D ₁	D ₂
	(mm)	1.90 ± 0.10	3.80 ± 0.10	1.05 ± 0.10	1.55 ± 0.10	178 ± 1	60.0 MIN.	13.0 ± 0.20
	(inch)	0.075 ± 0.004	0.150 ± 0.004	0.041 ± 0.004	0.061 ± 0.004	7.008 ± 0.04	2.362 MIN.	0.512 ± 0.008

SOD-123F	SYMBOL	E	F	P	P ₀	P ₁	T	W	W ₁
	(mm)	1.75 ± 0.10	3.50 ± 0.05	4.00 ± 0.10	4.00 ± 0.10	2.00 ± 0.05	0.22 ± 0.05	8.00 ± 0.20	13.5 MAX.
	(inch)	0.069 ± 0.004	0.138 ± 0.002	0.157 ± 0.004	0.157 ± 0.004	0.079 ± 0.004	0.009 ± 0.002	0.315 ± 0.008	0.531 MAX.

Marking Code

Part Number	Marking Code
CDBK0520L-HF	BM



Suggested PAD Layout

SIZE	SOD-123F	
	(mm)	(inch)
A	3.45	0.136
B	1.30	0.051
C	1.60	0.063
D	4.75	0.187
E	2.15	0.085

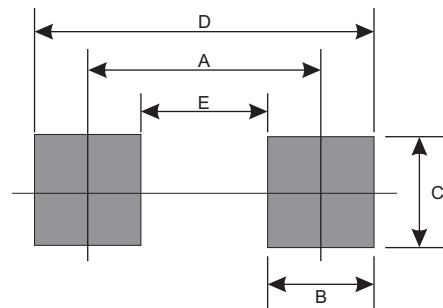

Standard Package

Case Type	Qty per Reel	Reel Size
	(Pcs)	(inch)
SOD-123F	3000	7

Looking for pricing, stock, or lifecycle information?

Click below to explore more details on WIN SOURCE:

- ⊖ [View CDBK0520L-HF](#) on WIN SOURCE
- ⊖ [Comchip Technology](#) Information

Optimize Your Supply Chain with WIN SOURCE Solutions

- ✓ Global Sourcing Solution
- ✓ Obsolete Management
- ✓ Cost Control Management
- ✓ Shortage Management
- ✓ Alternative Solution
- ✓ Excess Inventory Management