



# THE DATASHEET OF MP156



**SINGLE-PHASE GLASS PASSIVATED  
SILICON BRIDGE RECTIFIER**

**VOLTAGE RANGE 50 to 1000 Volts CURRENT 15 Amperes**

**FEATURES**

- \* Superior thermal desing
- \* 300 amperes surge rating
- \* 1/4" universal faston terminal
- \* Hole thru for # 10 screw

**MECHANICAL DATA**

- \* UL listed the recognized component directory, file #E94233
- \* Epoxy: Device has UL flammability classification 94V-O

**MAXIMUM RATINGS AND ELECTRICAL CHARACTERISTICS**

Ratings at 25°C ambient temperature unless otherwise specified.  
resistive or inductive load.

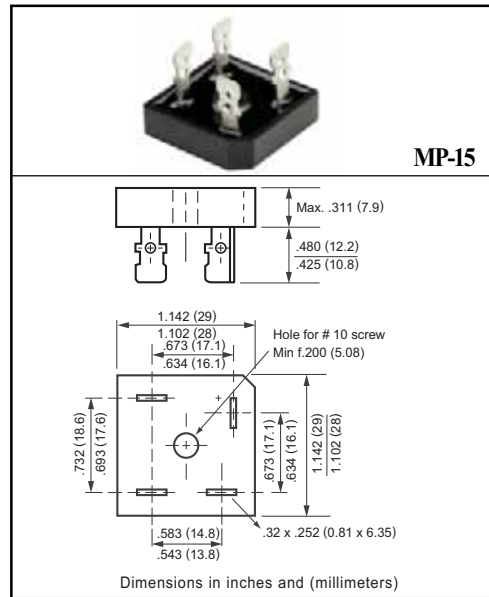

**MAXIMUM RATINGS** (At TA = 25°C unless otherwise noted)

RATINGS	SYMBOL	MP1505	MP151	MP152	MP154	MP156	MP158	MP1510	UNITS
Maximum Recurrent Peak Reverse Voltage	V <sub>RRM</sub>	50	100	200	400	600	800	1000	Volts
Maximum RMS Bridge Input Voltage	V <sub>RMS</sub>	35	70	140	280	420	560	700	Volts
Maximum DC Blocking Voltage	V <sub>DC</sub>	50	100	200	400	600	800	1000	Volts
Maximum Average Forward Output Current at Tc = 55°C	I <sub>o</sub>	15.0							Amps
Peak Forward Surge Current 8.3 ms single half sine-wave superimposed on rated load (JEDEC method)	I <sub>FSM</sub>	300							Amps
Typical Current Squarad Time	I <sup>2</sup> <sub>t</sub>	373.3							A <sup>2</sup> /Sec
RMS isolation voltage from case to lead	V <sub>ISO</sub>	2500							Volts
Typical Thermal Resistance (from junction to case)	R <sub>θJC</sub>	2							°C/W
Typical Thermal Resistance (from junction to ambient)	R <sub>θJA</sub>	19							
Operating and Storage Temperature Range	T <sub>J,TSTG</sub>	-55 to + 150							°C

**ELECTRICAL CHARACTERISTICS** (At TA = 25°C unless otherwise noted)

CHARACTERISTICS	SYMBOL	MP1505	MP151	MP152	MP154	MP156	MP158	MP1510	UNITS	
Maximum Forward Voltage Drop per element at 7.5A DC	V <sub>F</sub>	1.05								Volts
Maximum Reverse Current at Rated	I <sub>R</sub>	0.5								uAmps
DC Blocking Voltage per element		500								uAmps

NOTE: 1. Suffix "W" for wire type  
2. "RoHS compliant"

2023-06  
REV:E

## RATING AND CHARACTERISTIC CURVES ( MP1505 THRU MP1510 )

FIG. 1 - MAXIMUM NON-REPETITIVE FORWARD SURGE CURRENT

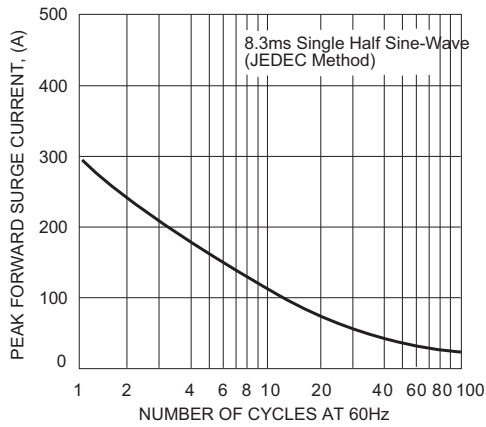

FIG. 2 - TYPICAL FORWARD CURRENT DERATING CURVE

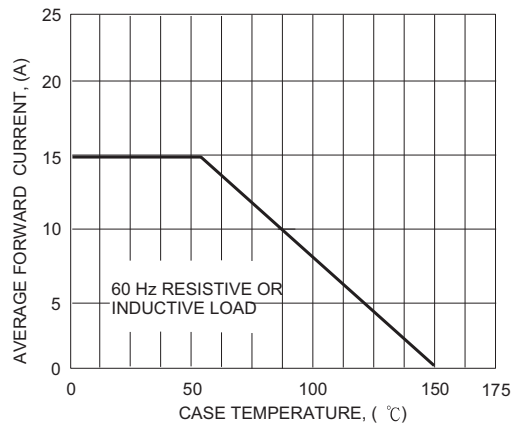

FIG. 3 - TYPICAL INSTANTANEOUS FORWARD CHARACTERISTICS

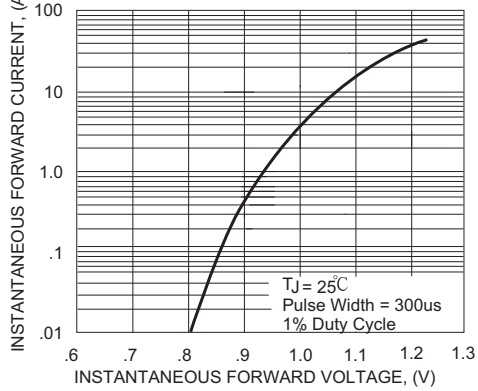
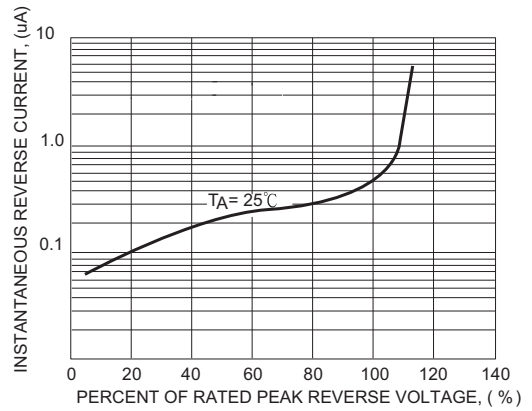
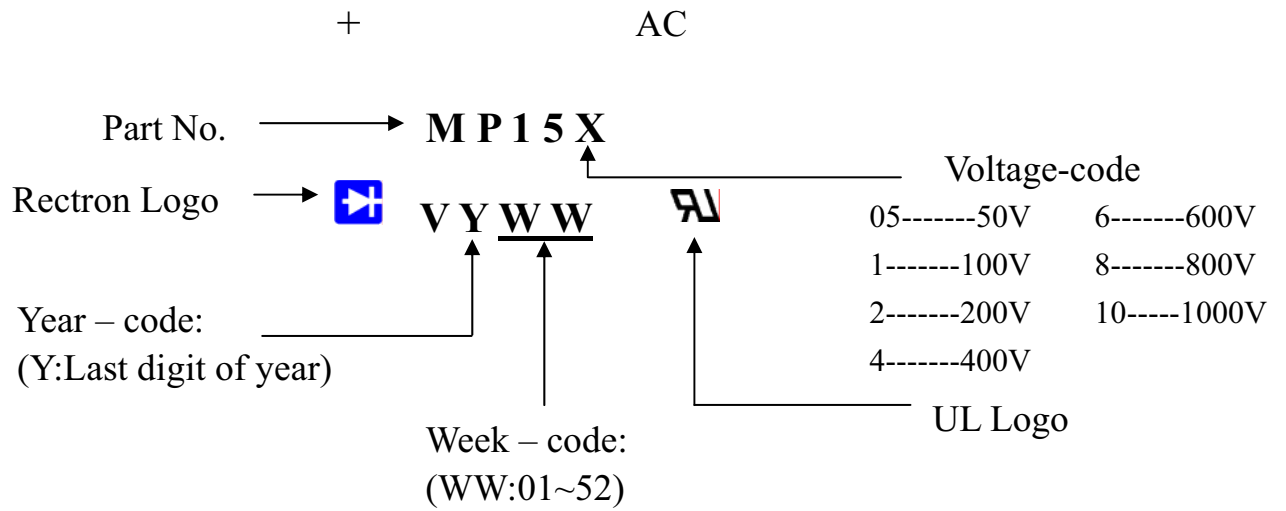

FIG. 4 - MAXIMUM REVERSE CHARACTERISTICS



## Marking Description



## PACKAGING OF DIODE AND BRIDGE RECTIFIERS

### BULK PACK

PACKAGE	PACKING CODE	EA PER BOX	INNER BOX SIZE (mm)	CARTON SIZE (mm)	EA PER CARTON	GROSS WEIGHT(Kg)
MP-15/-25/-35	-B	50	206*208*45.5	450*220*255	500	9.6



## DISCLAIMER NOTICE

Rectron Inc reserves the right to make changes without notice to any product specification herein, to make corrections, modifications, enhancements or other changes. Rectron Inc or anyone on its behalf assumes no responsibility or liability for any errors or inaccuracies. Data sheet specifications and its information contained are intended to provide a product description only. "Typical" parameters which may be included on RECTRON data sheets and/ or specifications can and do vary in different applications and actual performance may vary over time. Rectron Inc does not assume any liability arising out of the application or use of any product or circuit.

Rectron products are not designed, intended or authorized for use in medical, life-saving implant or other applications intended for life-sustaining or other related applications where a failure or malfunction of component or circuitry may directly or indirectly cause injury or threaten a life without expressed written approval of Rectron Inc. Customers using or selling Rectron components for use in such applications do so at their own risk and shall agree to fully indemnify Rectron Inc and its subsidiaries harmless against all claims, damages and expenditures.

## Looking for pricing, stock, or lifecycle information?

Click below to explore more details on WIN SOURCE:

-  [View MP156 on WIN SOURCE](#)
-  [Rectron USA Information](#)

## Optimize Your Supply Chain with WIN SOURCE Solutions

-  Global Sourcing Solution
-  Obsolete Management
-  Cost Control Management
-  Shortage Management
-  Alternative Solution
-  Excess Inventory Management