



**THE DATASHEET OF  
NSVR201MXT5G**



# NSVR201MX

## Schottky Barrier Diode for Mixer and Detector

Automotive Schottky Barrier Diode designed for compact and efficient designs. AEC-Q101 qualified Schottky Barrier Diode and PPAP capable suitable for automotive applications.

### Features

- Small Interterminal Capacitance
- Less Parasitic Components
- Small Forward Voltage
- Small-sized Package
- Pb-Free, Halogen Free and RoHS Compliant
- AEC-Q101 Qualified and PPAP Capable

### Typical Applications

- Microwave and Submilliwave Mixer
- Microwave and Submilliwave Detector

### Specifications

Table 1. ABSOLUTE MAXIMUM RATINGS at  $T_A = 25^\circ\text{C}$

Parameter	Symbol	Value	Unit
Reverse Voltage	$V_R$	2	V
Forward Current	$I_F$	50	mA
Operating Junction and Storage Temperature	$T_J, T_{stg}$	-55 to +150	$^\circ\text{C}$

Stresses exceeding those listed in the Maximum Ratings table may damage the device. If any of these limits are exceeded, device functionality should not be assumed, damage may occur and reliability may be affected.



ON Semiconductor®

[www.onsemi.com](http://www.onsemi.com)

2 V, 50 mA  
C = 0.15 pF typ.  
Schottky Barrier Diode



X2DFN2 1.0 x 0.6, 0.65P  
CASE 714AB

### ELECTRICAL CONNECTION

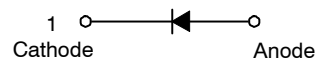

### MARKING DIAGRAM



RF = Specific Device Code  
M = Date Code

### ORDERING INFORMATION

See detailed ordering and shipping information on page 2 of this data sheet.

# NSVR201MX

**Table 2. ORDERING INFORMATION**

Device	Marking	Package	Shipping†
NSVR201MXT5G	RF	X2DFN2 1.0 x 0.65 P (Pb-Free / Halogen Free)	8,000 / Tape & Reel

†For information on tape and reel specifications, including part orientation and tape sizes, please refer to our Tape and Reel Packaging Specification Brochure, BRD8011/D.

**Table 3. ELECTRICAL CHARACTERISTICS** at  $T_A = 25^\circ\text{C}$  (Notes 1, 2)

Parameter	Symbol	Conditions	Value			Units
			Min	Typ	Max	
Reverse Voltage	$V_R$	$I_R = 10 \mu\text{A}$	2			V
Forward Voltage	$V_F$	$I_F = 1 \text{ mA}$			320	mV
Series Resistance	$R_S$	$I_F = 10 \text{ mA}$		14	18	$\Omega$
Interterminal Capacitance	C	$V_R = 0 \text{ V}, f = 1 \text{ MHz}$		0.15	0.20	pF

1. Product parametric performance is indicated in the Electrical Characteristics for the listed test conditions, unless otherwise noted. Product performance may not be indicated by the Electrical Characteristics if operated under different conditions.
2. Pay attention to handling since it is liable to be affected by static electricity due to the high-frequency process adopted.

# NSVR201MX

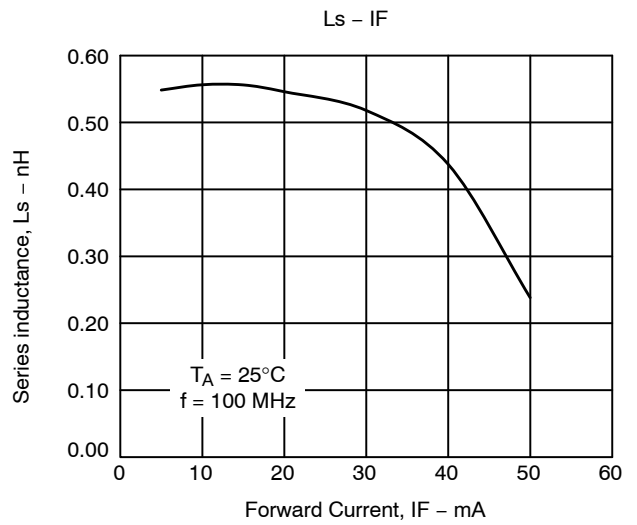
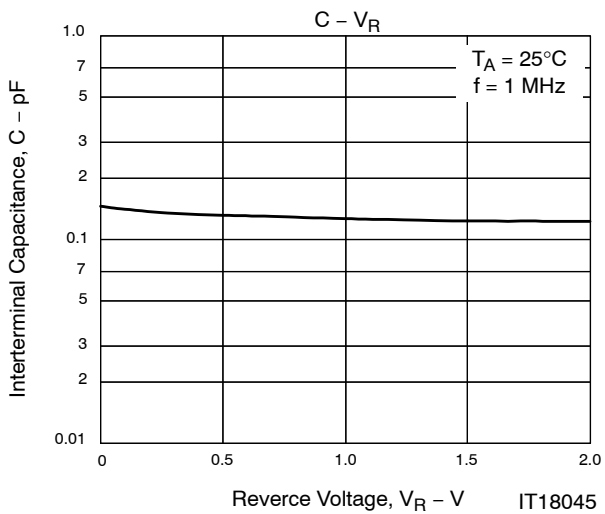
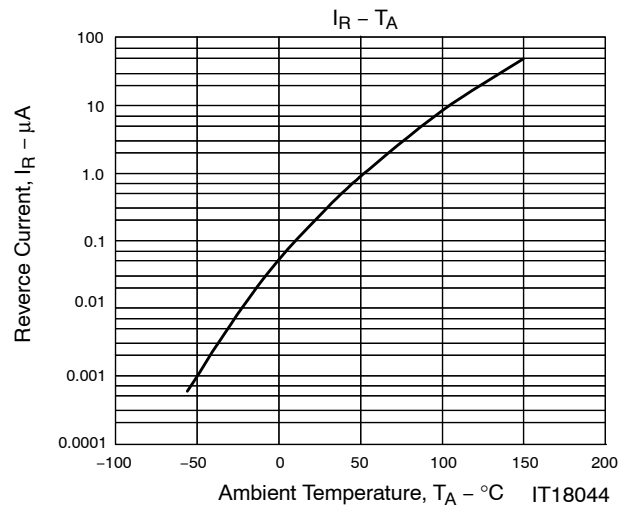
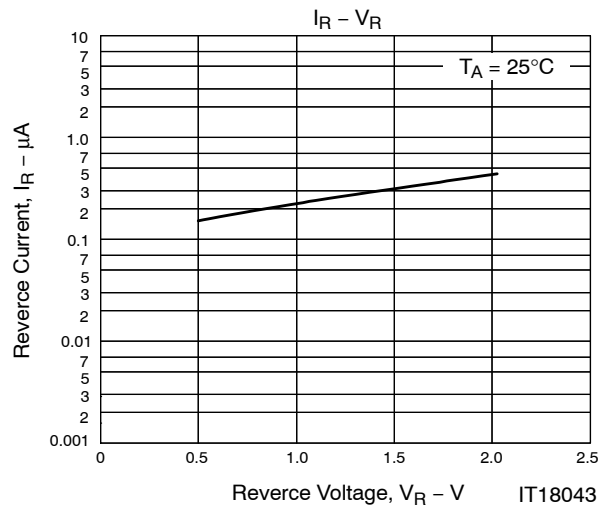
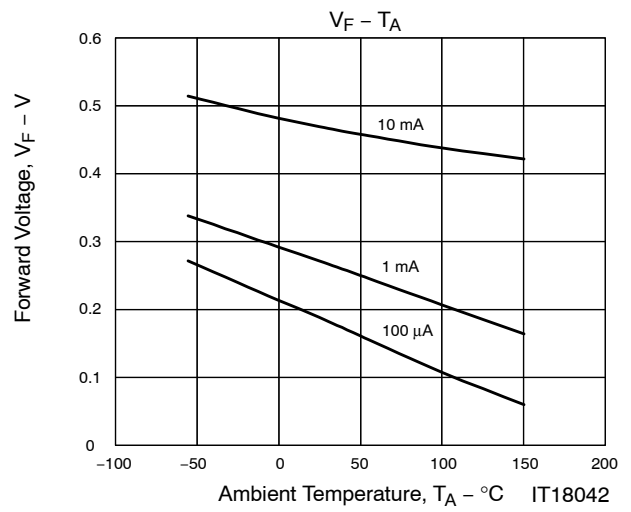
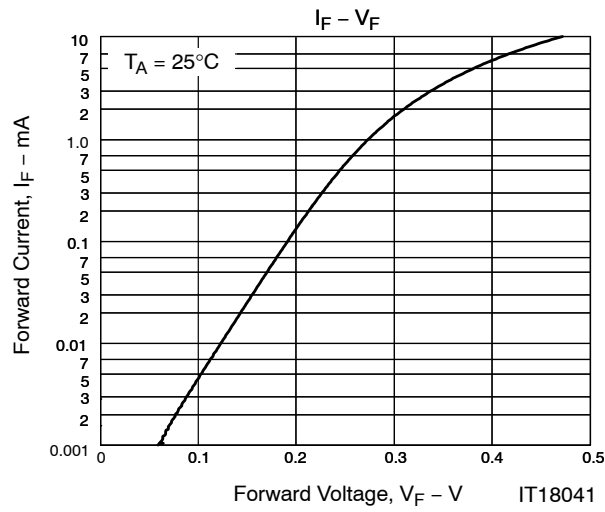
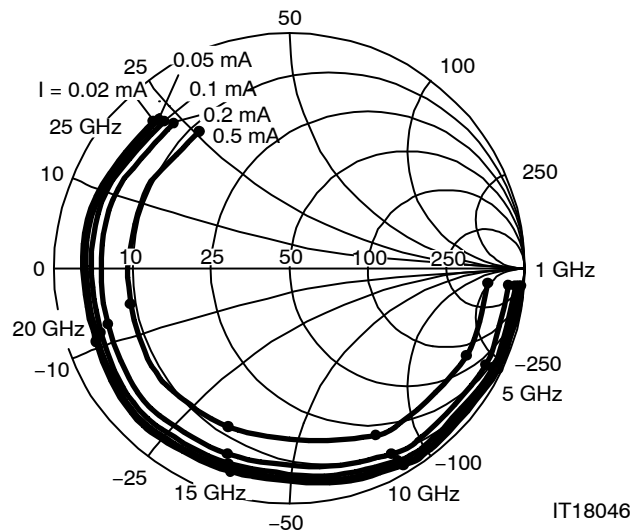

Figure 1.

# NSVR201MX

**Table 4. S PARAMETER** ( $Z_0 = 50 \Omega$ )

Freq [GHz]	I = 0 mA		I = 0.02 mA		I = 0.05 mA		I = 0.1 mA		I = 0.2 mA		I = 0.5 mA	
	MAG	ANG	MAG	ANG	MAG	ANG	MAG	ANG	MAG	ANG	MAG	ANG
1	0.964	-4.4	0.988	-4.3	0.978	-4.3	0.963	-4.3	0.933	-4.4	0.845	-4.3
2	0.967	-9.7	0.990	-9.6	0.981	-9.6	0.966	-9.7	0.937	-9.7	0.852	-9.5
3	0.957	-15.2	0.981	-15.1	0.971	-15.2	0.956	-15.2	0.925	-15.4	0.838	-15.7
4	0.956	-20.5	0.980	-20.3	0.970	-20.5	0.956	-20.5	0.925	-20.6	0.840	-20.4
5	0.961	-26.0	0.986	-25.7	0.977	-25.9	0.960	-26.0	0.929	-26.2	0.838	-26.3
6	0.954	-32.3	0.981	-31.9	0.970	-32.1	0.953	-32.3	0.919	-32.5	0.822	-32.5
7	0.943	-39.2	0.969	-38.7	0.959	-39.0	0.942	-39.2	0.909	-39.6	0.814	-40.4
8	0.943	-45.7	0.967	-45.2	0.958	-45.4	0.942	-45.7	0.911	-46.2	0.823	-47.4
9	0.947	-52.8	0.975	-52.2	0.963	-52.5	0.946	-52.8	0.910	-53.3	0.809	-54.2
10	0.940	-60.6	0.968	-59.9	0.957	-60.2	0.938	-60.6	0.902	-61.2	0.799	-62.6
11	0.921	-69.7	0.950	-68.9	0.939	-69.3	0.919	-69.7	0.883	-70.4	0.777	-72.0
12	0.895	-80.4	0.928	-79.4	0.914	-79.9	0.893	-80.4	0.852	-81.2	0.738	-83.5
13	0.882	-88.8	0.912	-87.7	0.900	-88.2	0.881	-88.8	0.843	-89.6	0.735	267.9
14	0.872	261.9	0.906	263.1	0.893	262.4	0.871	261.9	0.831	261.0	0.715	258.8
15	0.870	252.7	0.900	253.9	0.887	253.2	0.868	252.6	0.830	251.6	0.723	249.0
16	0.874	242.8	0.903	244.1	0.891	243.4	0.873	242.7	0.838	241.6	0.733	238.1
17	0.874	231.6	0.907	233.1	0.894	232.3	0.873	231.6	0.833	230.4	0.720	227.0
18	0.877	220.8	0.911	222.5	0.898	221.6	0.875	220.7	0.833	219.3	0.715	215.4
19	0.860	210.3	0.895	212.1	0.881	211.1	0.859	210.2	0.817	208.7	0.700	204.2
20	0.847	198.7	0.880	200.7	0.866	199.6	0.845	198.7	0.806	197.2	0.692	192.7
21	0.841	185.5	0.875	187.4	0.860	186.4	0.840	185.4	0.800	184.0	0.687	179.7
22	0.847	171.1	0.883	173.3	0.868	172.2	0.846	171.1	0.803	169.3	0.683	164.0
23	0.845	157.2	0.877	159.6	0.864	158.3	0.843	157.1	0.804	155.1	0.696	149.5
24	0.822	142.0	0.854	144.5	0.840	143.2	0.821	142.1	0.782	140.1	0.680	134.7
25	0.823	130.3	0.852	132.6	0.840	131.4	0.822	130.3	0.788	128.6	0.695	123.3
26	0.833	118.3	0.863	120.7	0.850	119.5	0.832	118.2	0.797	116.5	0.703	111.1



**Figure 2.**

# MECHANICAL CASE OUTLINE

## PACKAGE DIMENSIONS

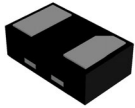

**X2DFN2 1.00x0.60x0.37, 0.65P**  
**CASE 714AB**  
**ISSUE C**

DATE 21 FEB 2024

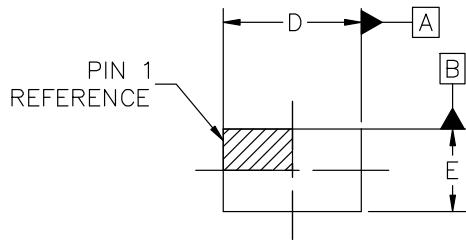

TOP VIEW

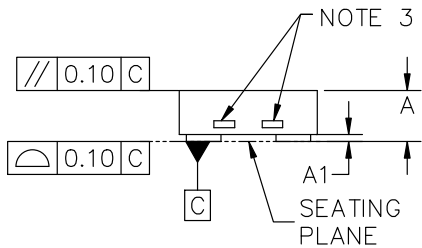

SIDE VIEW

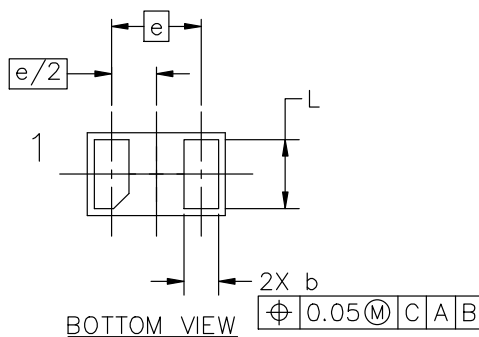

BOTTOM VIEW

NOTES:

1. DIMENSIONING AND TOLERANCING CONFORM TO ASME Y14.5–2018.
2. ALL DIMENSION ARE IN MILLIMETERS.
3. EXPOSED COPPER ALLOWED AS SHOW.

DIM	MILLIMETERS		
	MIN.	NOM.	MAX.
A	0.34	0.37	0.40
A1	---	0.03	0.050
b	0.20	0.25	0.30
D	0.95	1.00	1.05
E	0.55	0.60	0.65
e	0.65 BSC		
L	0.45	0.50	0.55

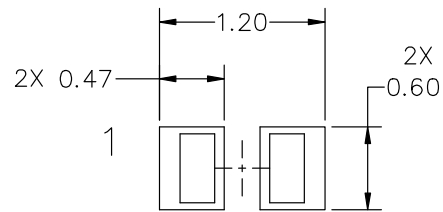

RECOMMENDED MOUNTING FOOTPRINT\*

\* FOR ADDITIONAL INFORMATION ON OUR Pb-FREE STRATEGY AND SOLDERING DETAILS, PLEASE DOWNLOAD THE ON SEMICONDUCTOR SOLDERING AND MOUNTING TECHNIQUES REFERENCE MANUAL, SOLDERRM/D.

**GENERIC MARKING DIAGRAM\***

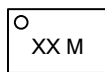

XX = Specific Device Code  
M = Date Code

\*This information is generic. Please refer to device data sheet for actual part marking. Pb-Free indicator, "G" or microdot "▪", may or may not be present. Some products may not follow the Generic Marking.

<b>DOCUMENT NUMBER:</b>	<b>98AON98172F</b>	Electronic versions are uncontrolled except when accessed directly from the Document Repository. Printed versions are uncontrolled except when stamped "CONTROLLED COPY" in red.
<b>DESCRIPTION:</b>	<b>X2DFN2 1.00x0.60x0.37, 0.65P</b>	<b>PAGE 1 OF 1</b>

onsemi and ONSEMI are trademarks of Semiconductor Components Industries, LLC dba onsemi or its subsidiaries in the United States and/or other countries. onsemi reserves the right to make changes without further notice to any products herein. onsemi makes no warranty, representation or guarantee regarding the suitability of its products for any particular purpose, nor does onsemi assume any liability arising out of the application or use of any product or circuit, and specifically disclaims any and all liability, including without limitation special, consequential or incidental damages. onsemi does not convey any license under its patent rights nor the rights of others.

**onsemi**, **Onsemi**, and other names, marks, and brands are registered and/or common law trademarks of Semiconductor Components Industries, LLC dba "**onsemi**" or its affiliates and/or subsidiaries in the United States and/or other countries. **onsemi** owns the rights to a number of patents, trademarks, copyrights, trade secrets, and other intellectual property. A listing of **onsemi**'s product/patent coverage may be accessed at [www.onsemi.com/site/pdf/Patent-Marking.pdf](http://www.onsemi.com/site/pdf/Patent-Marking.pdf). **onsemi** reserves the right to make changes at any time to any products or information herein, without notice. The information herein is provided "as-is" and **onsemi** makes no warranty, representation or guarantee regarding the accuracy of the information, product features, availability, functionality, or suitability of its products for any particular purpose, nor does **onsemi** assume any liability arising out of the application or use of any product or circuit, and specifically disclaims any and all liability, including without limitation special, consequential or incidental damages. Buyer is responsible for its products and applications using **onsemi** products, including compliance with all laws, regulations and safety requirements or standards, regardless of any support or applications information provided by **onsemi**. "Typical" parameters which may be provided in **onsemi** data sheets and/or specifications can and do vary in different applications and actual performance may vary over time. All operating parameters, including "Typicals" must be validated for each customer application by customer's technical experts. **onsemi** does not convey any license under any of its intellectual property rights nor the rights of others. **onsemi** products are not designed, intended, or authorized for use as a critical component in life support systems or any FDA Class 3 medical devices or medical devices with a same or similar classification in a foreign jurisdiction or any devices intended for implantation in the human body. Should Buyer purchase or use **onsemi** products for any such unintended or unauthorized application, Buyer shall indemnify and hold **onsemi** and its officers, employees, subsidiaries, affiliates, and distributors harmless against all claims, costs, damages, and expenses, and reasonable attorney fees arising out of, directly or indirectly, any claim of personal injury or death associated with such unintended or unauthorized use, even if such claim alleges that **onsemi** was negligent regarding the design or manufacture of the part. **onsemi** is an Equal Opportunity/Affirmative Action Employer. This literature is subject to all applicable copyright laws and is not for resale in any manner.

## ADDITIONAL INFORMATION

### TECHNICAL PUBLICATIONS:

Technical Library: [www.onsemi.com/design/resources/technical-documentation](http://www.onsemi.com/design/resources/technical-documentation)  
onsemi Website: [www.onsemi.com](http://www.onsemi.com)

### ONLINE SUPPORT: [www.onsemi.com/support](http://www.onsemi.com/support)

For additional information, please contact your local Sales Representative at [www.onsemi.com/support/sales](http://www.onsemi.com/support/sales)

## Looking for pricing, stock, or lifecycle information?

Click below to explore more details on WIN SOURCE:

⊖ [View NSVR201MXT5G](#) on WIN SOURCE

⊖ [ON Semiconductor](#) Information

## Optimize Your Supply Chain with WIN SOURCE Solutions

- ✓ Global Sourcing Solution
- ✓ Obsolete Management
- ✓ Cost Control Management
- ✓ Shortage Management
- ✓ Alternative Solution
- ✓ Excess Inventory Management