

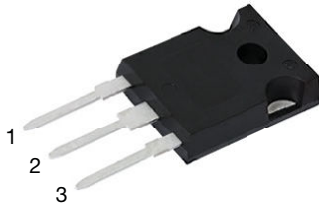

**THE DATASHEET OF
VS-HFA16PA120C-N3**

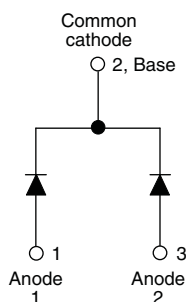

HEXFRED® Ultrafast Soft Recovery Diode, 2 x 8 A

TO-247AC 3L

FEATURES

- Ultrafast and ultrasoft recovery
- Very low I_{RRM} and Q_{rr}
- Designed and qualified according to JEDEC®-JESD 47
- Material categorization:
for definitions of compliance please see www.vishay.com/doc?99912

**RoHS
COMPLIANT
HALOGEN
FREE**
BENEFITS

- Reduced RFI and EMI
- Reduced power loss in diode and switching transistor
- Higher frequency operation
- Reduced snubbing
- Reduced parts count

DESCRIPTION

VS-HFA16PA120C... is a state of the art ultrafast recovery diode. Employing the latest in epitaxial construction and advanced processing techniques it features a superb combination of characteristics which result in performance which is unsurpassed by any rectifier previously available. With basic ratings of 1200 V and 8 A per leg continuous current, the VS-HFA16PA120C... is especially well suited for use as the companion diode for IGBTs and MOSFETs. In addition to ultrafast recovery time, the HEXFRED® product line features extremely low values of peak recovery current (I_{RRM}) and does not exhibit any tendency to “snap-off” during the t_b portion of recovery. The HEXFRED features combine to offer designers a rectifier with lower noise and significantly lower switching losses in both the diode and the switching transistor. These HEXFRED advantages can help to significantly reduce snubbing, component count and heatsink sizes. The HEXFRED VS-HFA16PA120C... is ideally suited for applications in power supplies and power conversion systems (such as inverters), motor drives, and many other similar applications where high speed, high efficiency is needed.

PRIMARY CHARACTERISTICS

$I_{F(AV)}$	2 x 8 A
V_R	1200 V
V_F at I_F	2.4 V
t_{rr} typ.	28 ns
T_J max.	150 °C
Package	TO-247AC 3L
Circuit configuration	Common cathode

ABSOLUTE MAXIMUM RATINGS

PARAMETER	SYMBOL	TEST CONDITIONS	VALUES	UNITS
Cathode to anode voltage	V_R		1200	V
Maximum continuous forward current	I_F	$T_C = 100\text{ °C}$	8	A
per leg			16	
per device				
Single pulse forward current	I_{FSM}	$t_p = 10\text{ ms}$	130	
Maximum repetitive forward current	I_{FRM}		32	
Maximum power dissipation	P_D	$T_C = 25\text{ °C}$	73.5	W
		$T_C = 100\text{ °C}$	29	
Operating junction and storage temperature range	T_J, T_{Stg}		-55 to +150	°C



ELECTRICAL SPECIFICATIONS PER LEG ($T_J = 25\text{ }^\circ\text{C}$ unless otherwise specified)						
PARAMETER	SYMBOL	TEST CONDITIONS	MIN.	TYP.	MAX.	UNITS
Cathode to anode breakdown voltage	V_{BR}	$I_R = 100\text{ }\mu\text{A}$	1200	-	-	V
Maximum forward voltage	V_{FM}	$I_F = 8.0\text{ A}$	-	2.6	3.3	
		$I_F = 16\text{ A}$	-	3.4	4.3	
		$I_F = 8.0\text{ A}, T_J = 125\text{ }^\circ\text{C}$	-	2.4	3.1	
Maximum reverse leakage current	I_{RM}	$V_R = V_R\text{ rated}$	-	0.31	10	μA
		$T_J = 125\text{ }^\circ\text{C}, V_R = 0.8 \times V_R\text{ rated}$	-	135	1000	
Junction capacitance	C_T	$V_R = 200\text{ V}$	-	11	20	pF
Series inductance	L_S	Measured lead to lead 5 mm from package	-	8.0	-	nH

DYNAMIC RECOVERY CHARACTERISTICS PER LEG ($T_J = 25\text{ }^\circ\text{C}$ unless otherwise specified)						
PARAMETER	SYMBOL	TEST CONDITIONS	MIN.	TYP.	MAX.	UNITS
Reverse recovery time	t_{rr}	$I_F = 1.0\text{ A}, di_F/dt = 200\text{ A}/\mu\text{s}, V_R = 30\text{ V}$	-	28	-	ns
	t_{rr1}	$T_J = 25\text{ }^\circ\text{C}$	-	63	95	
	t_{rr2}	$T_J = 125\text{ }^\circ\text{C}$	-	106	160	
Peak recovery current	I_{RRM1}	$T_J = 25\text{ }^\circ\text{C}$	-	4.5	8.0	A
	I_{RRM2}	$T_J = 125\text{ }^\circ\text{C}$	-	6.2	11	
Reverse recovery charge	Q_{rr1}	$T_J = 25\text{ }^\circ\text{C}$	-	140	380	nC
	Q_{rr2}	$T_J = 125\text{ }^\circ\text{C}$	-	335	880	
Peak rate of recovery current during t_b	$di_{(rec)M}/dt1$	$T_J = 25\text{ }^\circ\text{C}$	-	133	-	$\text{A}/\mu\text{s}$
	$di_{(rec)M}/dt2$	$T_J = 125\text{ }^\circ\text{C}$	-	85	-	

THERMAL - MECHANICAL SPECIFICATIONS						
PARAMETER	SYMBOL	TEST CONDITIONS	MIN.	TYP.	MAX.	UNITS
Lead temperature	T_{lead}	0.063" from case (1.6 mm) for 10 s	-	-	300	$^\circ\text{C}$
Thermal resistance, junction to case	R_{thJC}		-	-	1.7	K/W
Thermal resistance, junction to ambient	R_{thJA}	Typical socket mount	-	-	40	
Thermal resistance, case to heatsink	R_{thCS}	Mounting surface, flat, smooth, and greased	-	0.25	-	
Weight			-	6.0	-	g
			-	0.21	-	oz.
Mounting torque			6.0 (5.0)	-	12 (10)	kgf · cm (lbf · in)
Marking device		Case style TO-247AC 3L	HFA16PA120C			

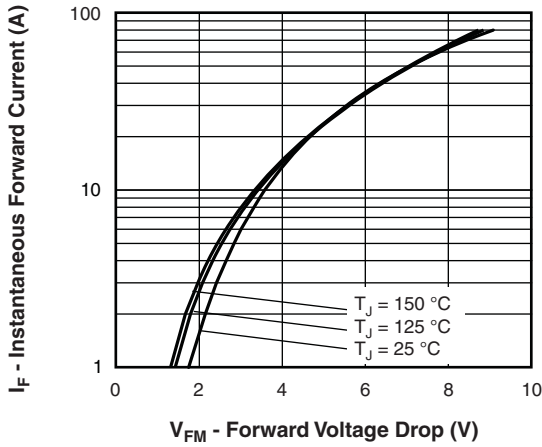

Fig. 1 - Maximum Forward Voltage Drop Characteristics

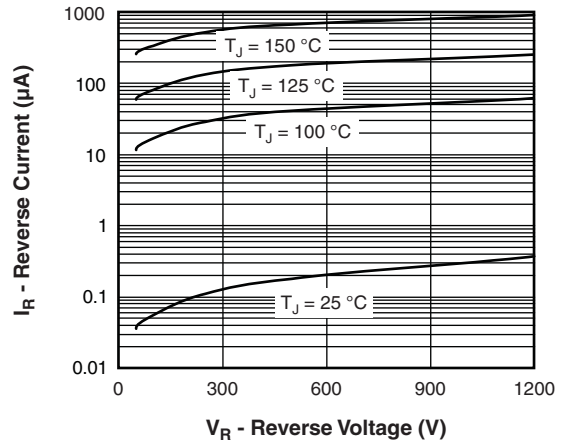

Fig. 2 - Typical Values of Reverse Current vs. Reverse Voltage

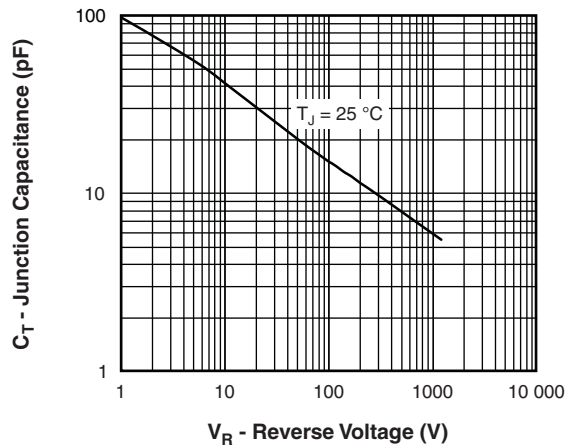

Fig. 3 - Typical Junction Capacitance vs. Reverse Voltage

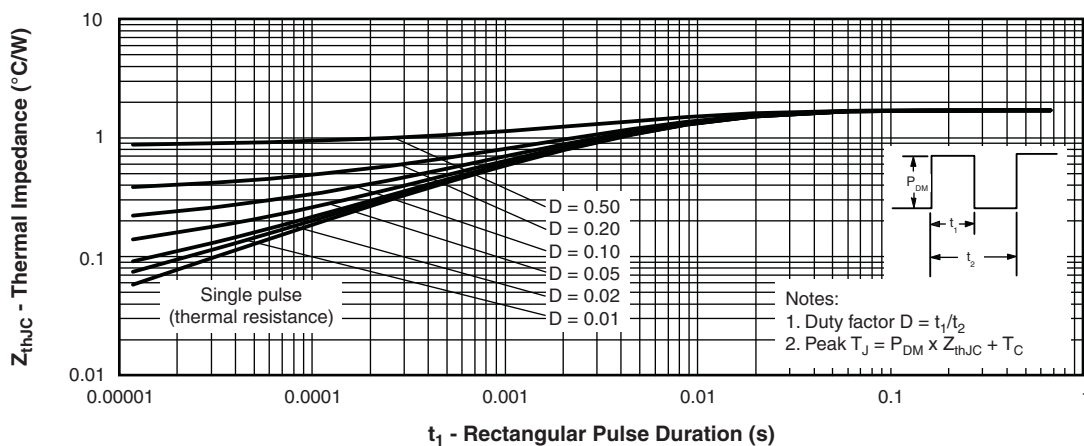

Fig. 4 - Maximum Thermal Impedance Z_{thJC} Characteristics

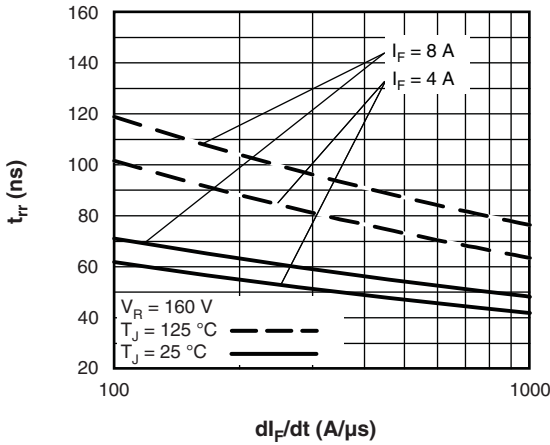

Fig. 5 - Typical Reverse Recovery Time vs. di_F/dt

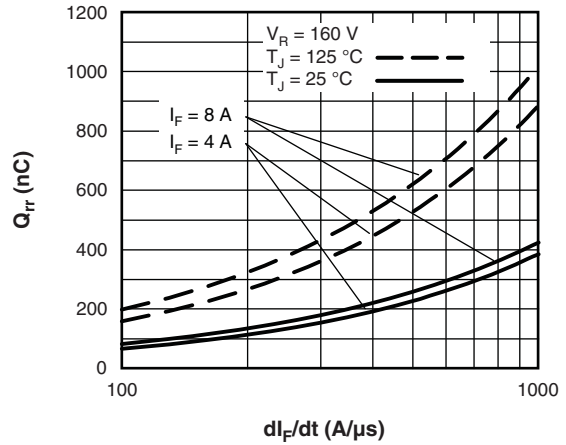

Fig. 7 - Typical Stored Charge vs. di_F/dt

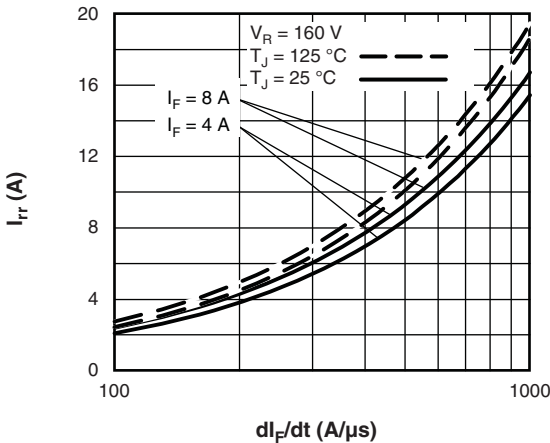

Fig. 6 - Typical Recovery Current vs. di_F/dt

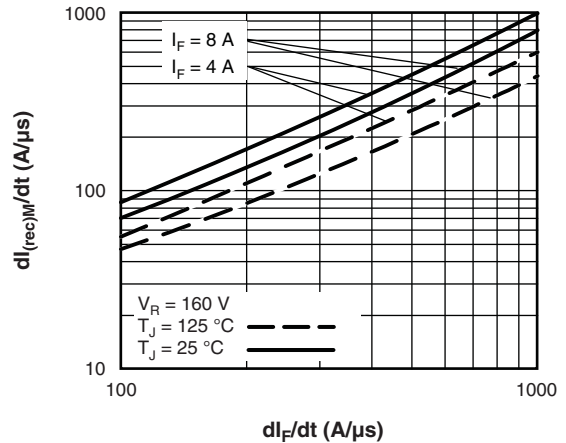

Fig. 8 - Typical $di_{(rec)M}/dt$ vs. di_F/dt

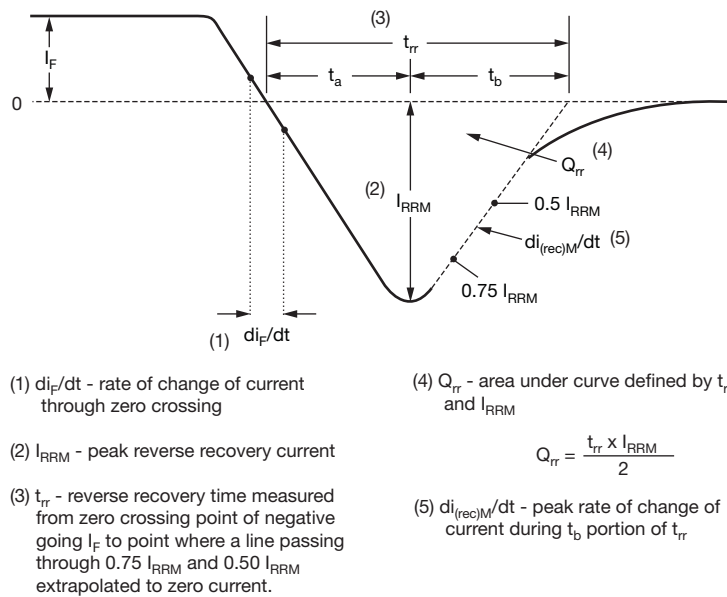
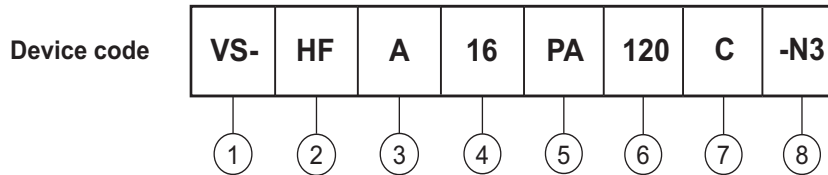

Fig. 9 - Reverse Recovery Waveform and Definitions



ORDERING INFORMATION TABLE



- 1** - Vishay Semiconductors product
- 2** - HEXFRED® family
- 3** - Electron irradiated
- 4** - Current rating (16 = 16 A)
- 5** - PA = TO-247AC, 3 pins
- 6** - Voltage rating: (120 = 1200 V)
- 7** - Circuit configuration
C = common cathode
- 7** - Environmental digit:
-N3 = halogen-free, RoHS-compliant, and totally lead (Pb)-free

ORDERING INFORMATION (Example)			
PREFERRED P/N	QUANTITY PER T/R	MINIMUM ORDER QUANTITY	PACKAGING DESCRIPTION
VS-HFA16PA120C-N3	25	500	Antistatic plastic tube

LINKS TO RELATED DOCUMENTS	
Dimensions	www.vishay.com/doc?96138
Part marking information	www.vishay.com/doc?95007

TO-247AC 3L

DIMENSIONS in millimeters and inches

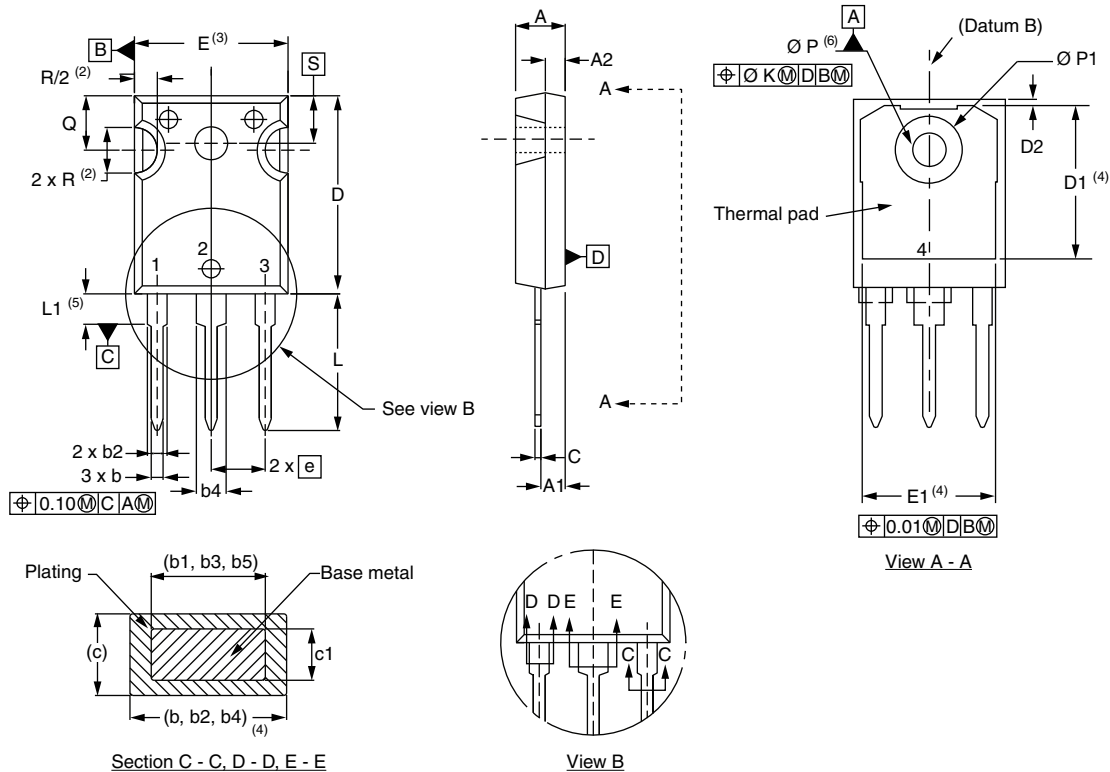

SYMBOL	MILLIMETERS		INCHES		NOTES	SYMBOL	MILLIMETERS		INCHES		NOTES
	MIN.	MAX.	MIN.	MAX.			MIN.	MAX.	MIN.	MAX.	
A	4.65	5.31	0.183	0.209		D2	0.51	1.35	0.020	0.053	
A1	2.21	2.59	0.087	0.102		E	15.29	15.87	0.602	0.625	3
A2	1.17	1.37	0.046	0.054		E1	13.46	-	0.53	-	
b	0.99	1.40	0.039	0.055		e	5.46 BSC		0.215 BSC		
b1	0.99	1.35	0.039	0.053		Ø K	0.254		0.010		
b2	1.65	2.39	0.065	0.094		L	14.20	16.10	0.559	0.634	
b3	1.65	2.34	0.065	0.092		L1	3.71	4.29	0.146	0.169	
b4	2.59	3.43	0.102	0.135		Ø P	3.56	3.66	0.14	0.144	
b5	2.59	3.38	0.102	0.133		Ø P1	-	7.39	-	0.291	
c	0.38	0.89	0.015	0.035		Q	5.31	5.69	0.209	0.224	
c1	0.38	0.84	0.015	0.033		R	4.52	5.49	0.178	0.216	
D	19.71	20.70	0.776	0.815	3	S	5.51 BSC		0.217 BSC		
D1	13.08	-	0.515	-	4						

Notes

- (1) Dimensioning and tolerancing per ASME Y14.5M-1994
- (2) Contour of slot optional
- (3) Dimension D and E do not include mold flash. Mold flash shall not exceed 0.127 mm (0.005") per side. These dimensions are measured at the outermost extremes of the plastic body
- (4) Thermal pad contour optional with dimensions D1 and E1
- (5) Lead finish uncontrolled in L1
- (6) Ø P to have a maximum draft angle of 1.5 to the top of the part with a maximum hole diameter of 3.91 mm (0.154")
- (7) Outline conforms to JEDEC® outline TO-247 with exception of dimension Q



Disclaimer

ALL PRODUCT, PRODUCT SPECIFICATIONS AND DATA ARE SUBJECT TO CHANGE WITHOUT NOTICE TO IMPROVE RELIABILITY, FUNCTION OR DESIGN OR OTHERWISE.

Vishay Intertechnology, Inc., its affiliates, agents, and employees, and all persons acting on its or their behalf (collectively, "Vishay"), disclaim any and all liability for any errors, inaccuracies or incompleteness contained in any datasheet or in any other disclosure relating to any product.

Vishay makes no warranty, representation or guarantee regarding the suitability of the products for any particular purpose or the continuing production of any product. To the maximum extent permitted by applicable law, Vishay disclaims (i) any and all liability arising out of the application or use of any product, (ii) any and all liability, including without limitation special, consequential or incidental damages, and (iii) any and all implied warranties, including warranties of fitness for particular purpose, non-infringement and merchantability.

Statements regarding the suitability of products for certain types of applications are based on Vishay's knowledge of typical requirements that are often placed on Vishay products in generic applications. Such statements are not binding statements about the suitability of products for a particular application. It is the customer's responsibility to validate that a particular product with the properties described in the product specification is suitable for use in a particular application. Parameters provided in datasheets and / or specifications may vary in different applications and performance may vary over time. All operating parameters, including typical parameters, must be validated for each customer application by the customer's technical experts. Product specifications do not expand or otherwise modify Vishay's terms and conditions of purchase, including but not limited to the warranty expressed therein.



Hyperlinks included in this datasheet may direct users to third-party websites. These links are provided as a convenience and for informational purposes only. Inclusion of these hyperlinks does not constitute an endorsement or an approval by Vishay of any of the products, services or opinions of the corporation, organization or individual associated with the third-party website. Vishay disclaims any and all liability and bears no responsibility for the accuracy, legality or content of the third-party website or for that of subsequent links.

Vishay products are not designed for use in life-saving or life-sustaining applications or any application in which the failure of the Vishay product could result in personal injury or death unless specifically qualified in writing by Vishay. Customers using or selling Vishay products not expressly indicated for use in such applications do so at their own risk. Please contact authorized Vishay personnel to obtain written terms and conditions regarding products designed for such applications.

No license, express or implied, by estoppel or otherwise, to any intellectual property rights is granted by this document or by any conduct of Vishay. Product names and markings noted herein may be trademarks of their respective owners.

Looking for pricing, stock, or lifecycle information?

Click below to explore more details on WIN SOURCE:

-  [View VS-HFA16PA120C-N3 on WIN SOURCE](#)
-  [Vishay Information](#)

Optimize Your Supply Chain with WIN SOURCE Solutions

-  Global Sourcing Solution
-  Obsolete Management
-  Cost Control Management
-  Shortage Management
-  Alternative Solution
-  Excess Inventory Management