



**THE DATASHEET OF
JS202011JAQN**



JS Series Sub-Miniature Slide Switches

Features/Benefits

- Positive detent
- Low profile
- IR reflow to 260° solder profile
- Surface and thru hole mounting
- SPDT, DPDT, DP3T models
- RoHS compliant

Typical Applications

- Telecommunication products
- Computer peripherals
- Thermostat select switch
- Instrumentation
- Medical

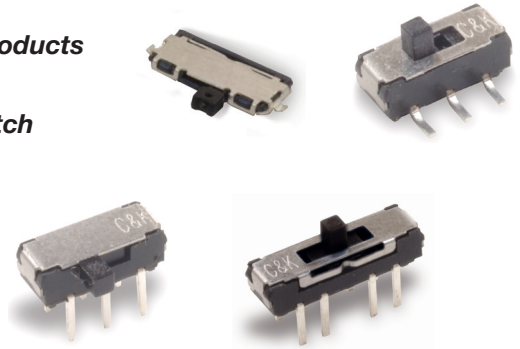

Specifications

CONTACT RATING: 0.3A@6VDC or 0.1A@30VDC
 ELECTRICAL LIFE: 5,000 make-and-break cycles
 CONTACT RESISTANCE: 70 m Ω max.
 INSULATION RESISTANCE: 100 M Ω min. @ 500V
 DIELECTRIC STRENGTH: 500 VAC min. @ sea level
 OPERATING TEMPERATURE: -40°C to +85°C
 STORAGE TEMPERATURE: -40°C to +85°C

NOTE: Specifications and materials listed above are for switches with standard options.
 For information on specific and custom switches, consult Customer Service Center.

Materials

HOUSING: 4/6 nylon, black
 ACTUATOR: 4/6 nylon, black (some options white)
 CONTACTS: Copper alloy, silver or gold plated
 TERMINALS: Brass, silver or gold plated

How To Order

Our easy build-a-switch concept allows you to mix and match options to create the switch you need. To order, select desired option from each category and place it in the appropriate box.

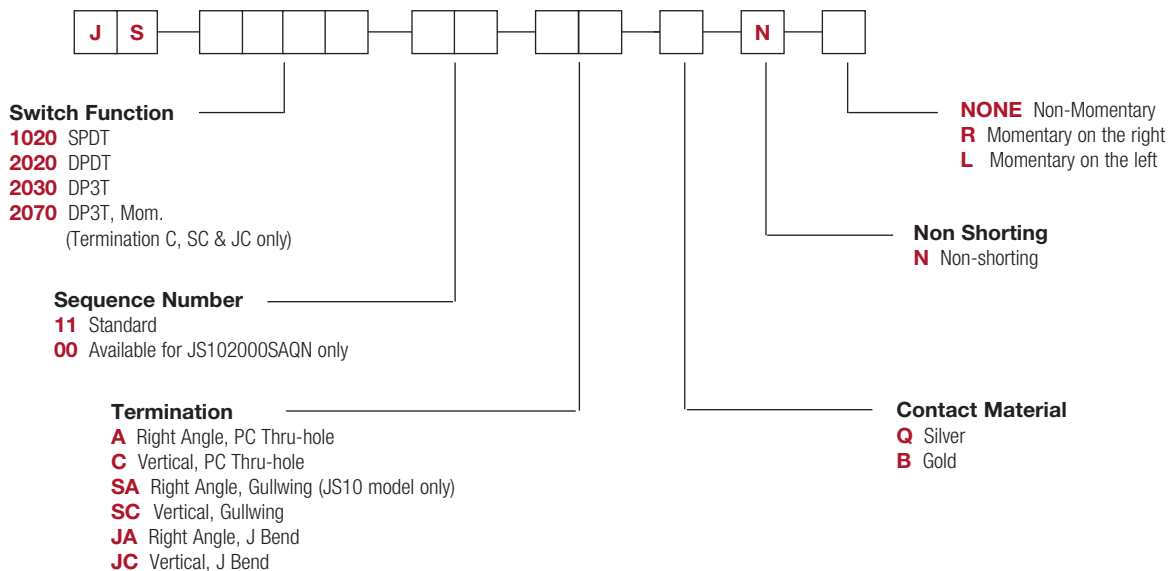

JS Series Sub-Miniature Slide Switches

RIGHT ANGLE, PC THRU-HOLE

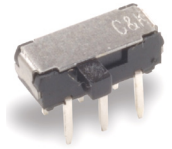
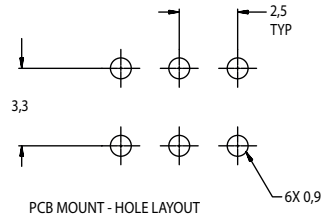
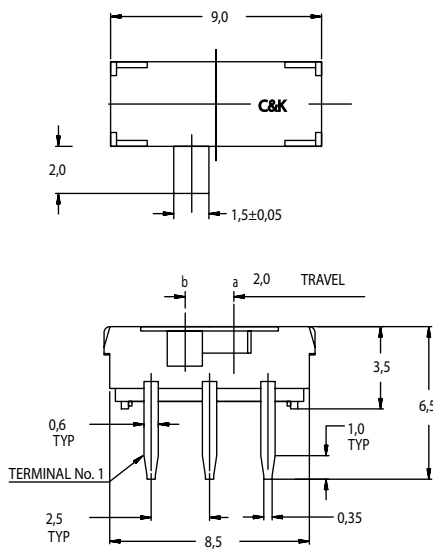

Part Number
JS202011AQN
DPDT

Shown in position b

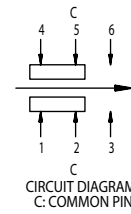
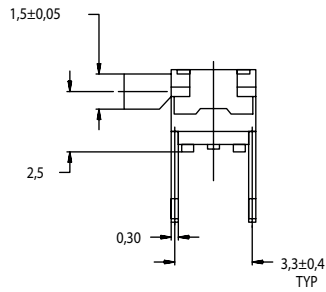

Shown in position b



Slide

JS Series Sub-Miniature Slide Switches

RIGHT ANGLE, PC THRU-HOLE

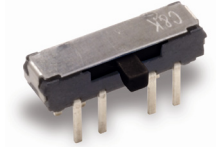
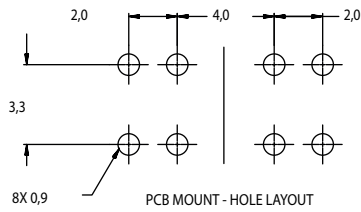
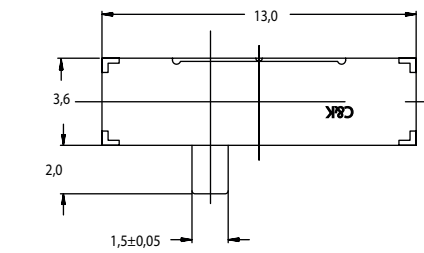

Part Number
JS203011AQN
DP3T

Shown in position b

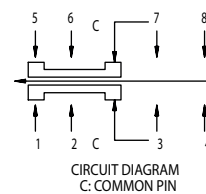
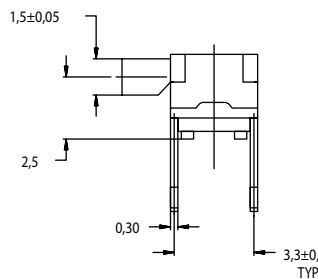
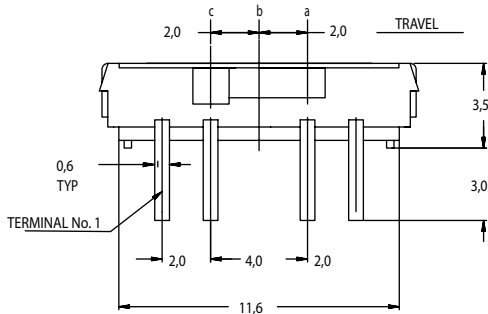

CIRCUIT DIAGRAM
C: COMMON PIN

Shown in position c

PC THRU-HOLE

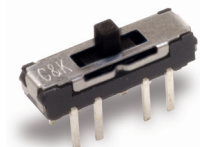
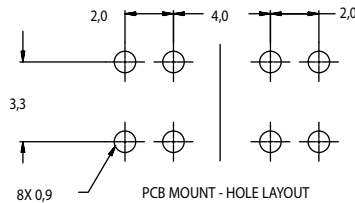
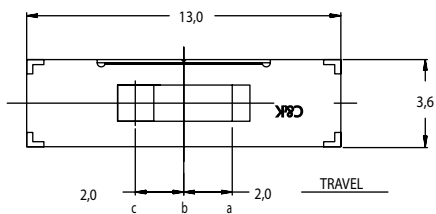

Part Number
JS203011CQN
DP3T

Shown in position b

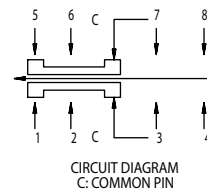
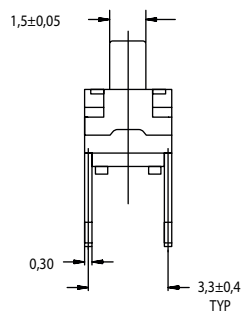
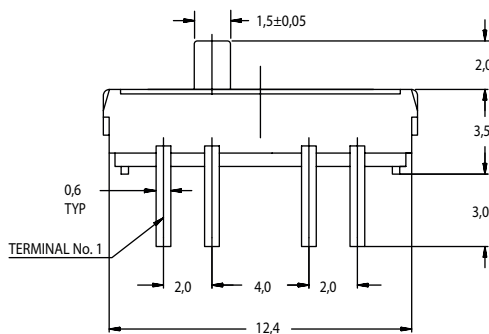

CIRCUIT DIAGRAM
C: COMMON PIN

Shown in position c

JS Series Sub-Miniature Slide Switches

PC THRU-HOLE

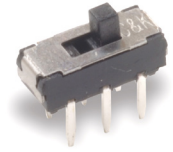
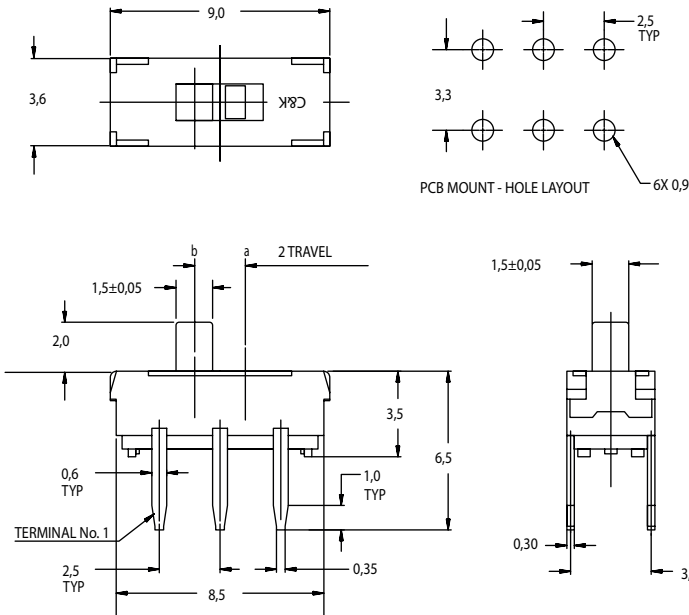

Part Number
JS202011CQN
DPDT

Shown in position a

Shown in position b

SURFACE MOUNT

Part number
JS202011SCQN
DPDT

Shown in position b. Quantity per reel 1000
Available in tape & reel only

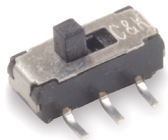
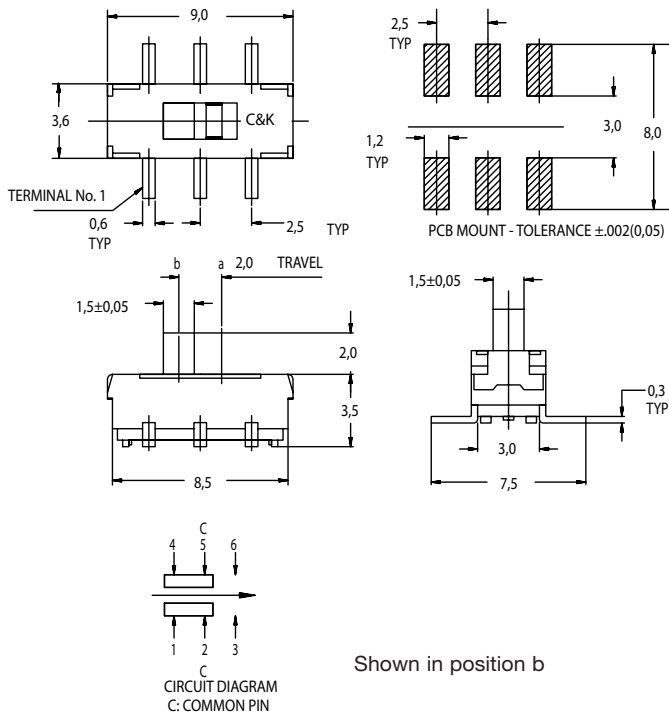

Part number
JS203011SCQN
DP3T

Quantity per reel 900
Available in tape & reel only

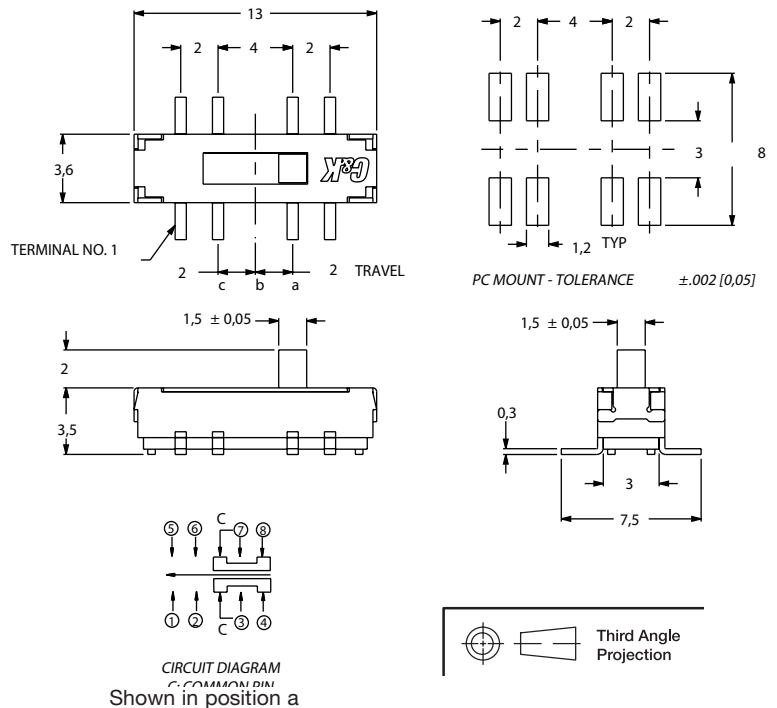

Third Angle Projection

JS Series Sub-Miniature Slide Switches

RIGHT ANGLE SURFACE MOUNT

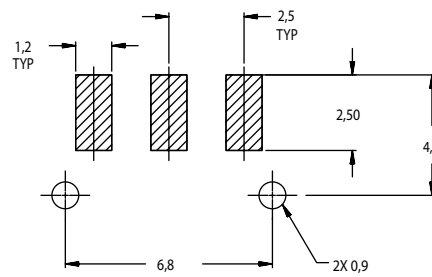
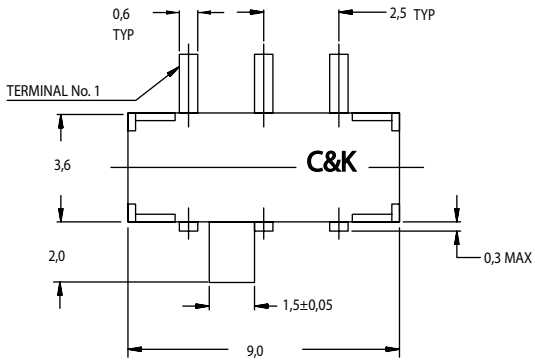

Part Number
JS102011SAQN
SPDT

Shown in position a

Available in tape & reel only

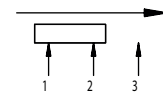
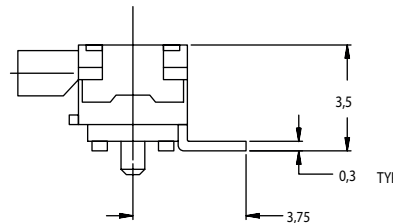
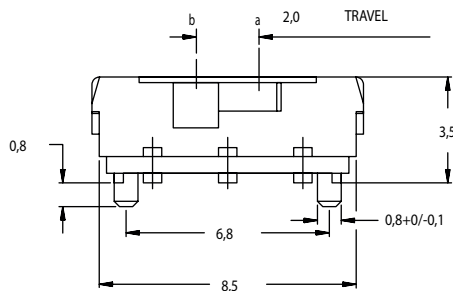

CIRCUIT DIAGRAM
C: COMMON PIN

Shown in position b

PC THRU-HOLE

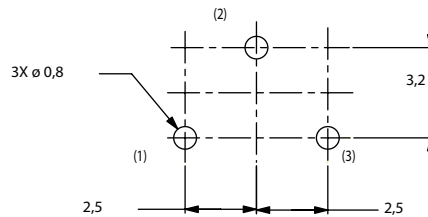
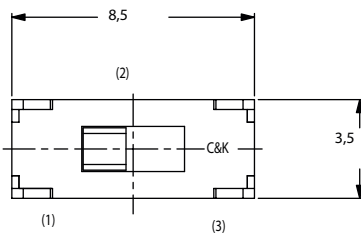

PCB LAYOUT RECOMMENDED

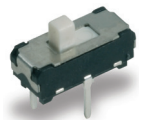

Part Number
JS102011CQN
SPDT

Shown in position a

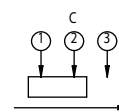
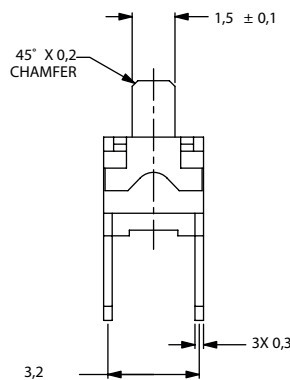
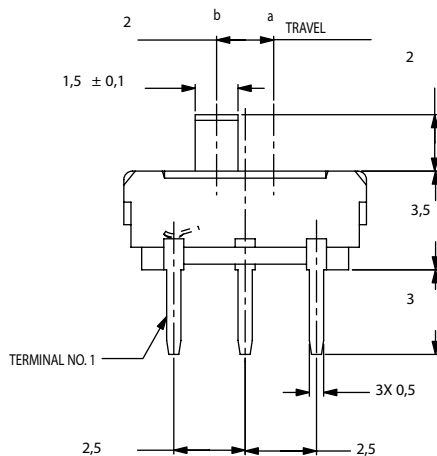

SCHMATIC

Shown in position b

JS Series Sub-Miniature Slide Switches

PC THRU-HOLE

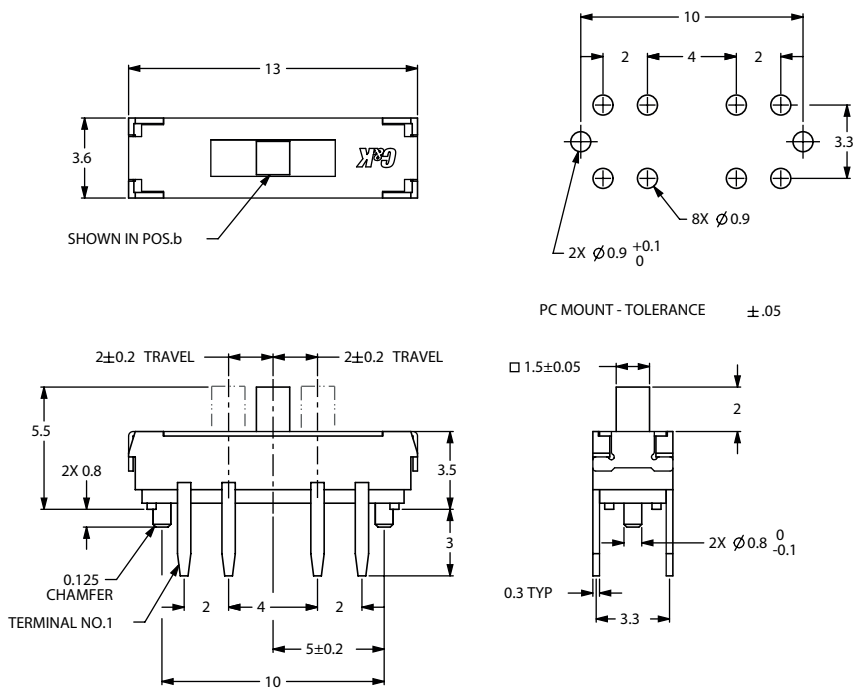

PC MOUNT - TOLERANCE ±.05

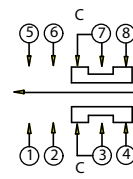

CIRCUIT DIAGRAM
C: COMMON PIN
BOTTOM VIEW

SWITCH FUNCTION		
POS.c	POS.b	POS.a
(MOM)	ON	ON
CONNECTED TERMINALS		
1-3,5-7	2-3,6-7	3-4,7-8

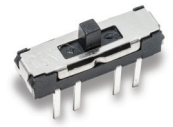

Part Number
JS207011CQNR
DP3T

Shown in position b

RIGHT ANGLE SURFACE MOUNT

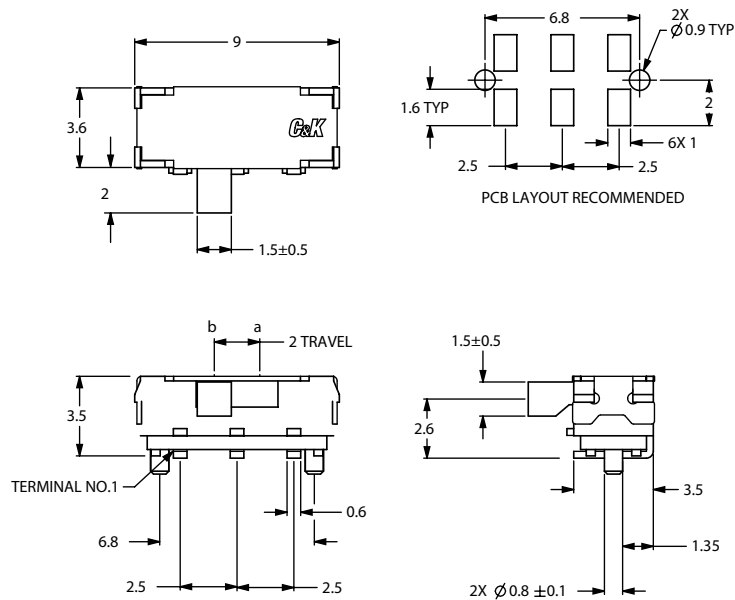

PCB LAYOUT RECOMMENDED

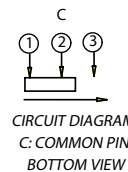

CIRCUIT DIAGRAM
C: COMMON PIN
BOTTOM VIEW



Part Number
JS102011JAQN
SPDT

Shown in position

Available in tape & reel
only

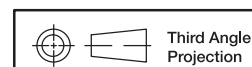

Third Angle
Projection

Dimensions are shown: mm
Specifications and dimensions subject to change

JS Series Sub-Miniature Slide Switches

VERTICAL MOUNT SMT - J BEND

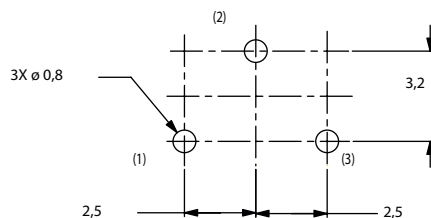
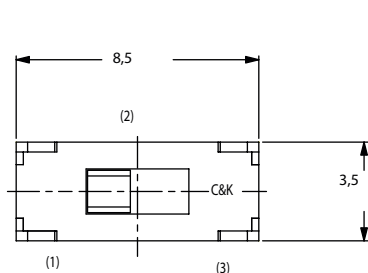

Part Number
JS102011JCQN
SPDT

Available in tape & reel
only

PCB LAYOUT RECOMMENDED

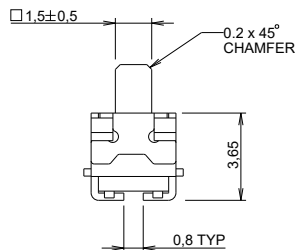
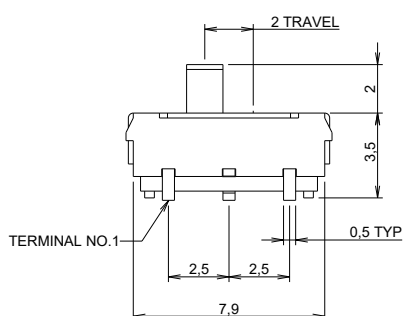

RIGHT ANGLE SURFACE MOUNT

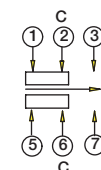
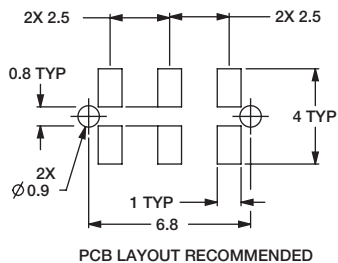
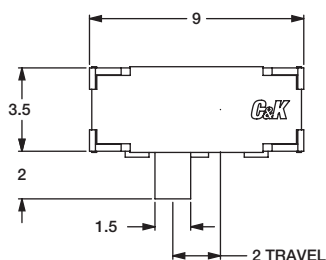

CIRCUIT DIAGRAM
C: COMMON PIN
BOTTOM VIEW



Part Number
JS202011JAQN
DPDT

Shown in position

Available in tape & reel
only

PCB LAYOUT RECOMMENDED

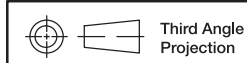
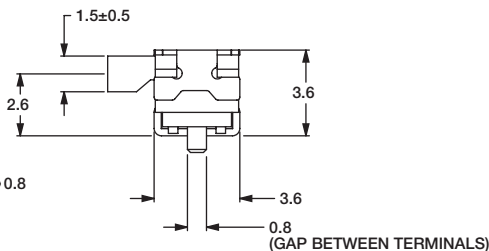
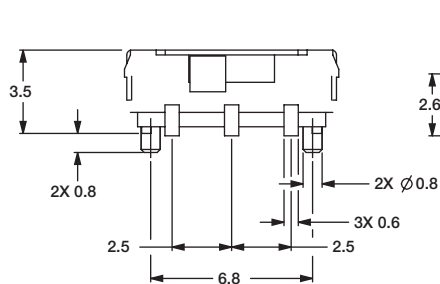

Third Angle
Projection

Dimensions are shown: mm
Specifications and dimensions subject to change

JS Series Sub-Miniature Slide Switches

VERTICAL MOUNT SMT - J BEND

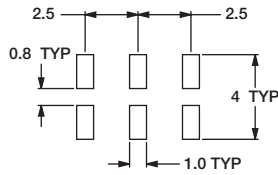
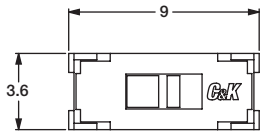

PCB LAYOUT RECOMMENDED

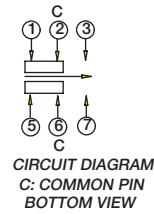

Part Number
JS202011JCQN

DPDT

Shown in position

Available in tape & reel only

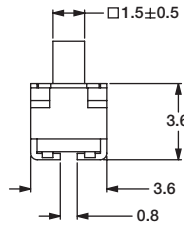
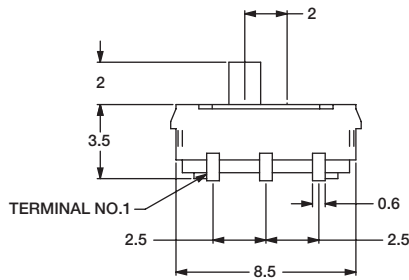

RIGHT ANGLE MOUNT SMT - J BEND

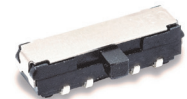
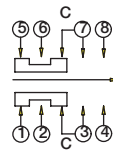
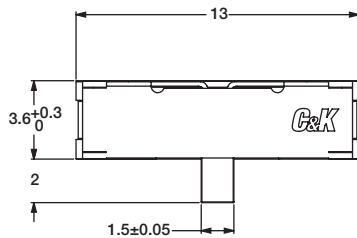

Part Number
JS203011JAQN
DP3T

Shown in position

Available in tape & reel only

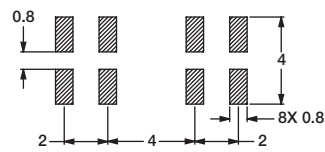
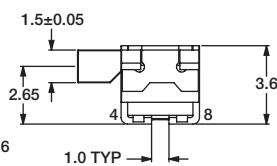
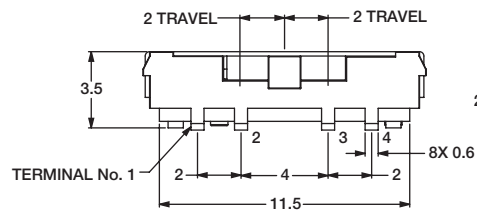

PCB LAYOUT RECOMMENDED

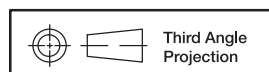

Dimensions are shown: mm
Specifications and dimensions subject to change

JS Series Sub-Miniature Slide Switches

VERTICAL MOUNT SMT - J BEND

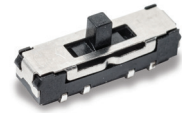
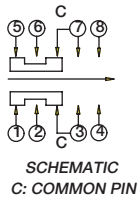
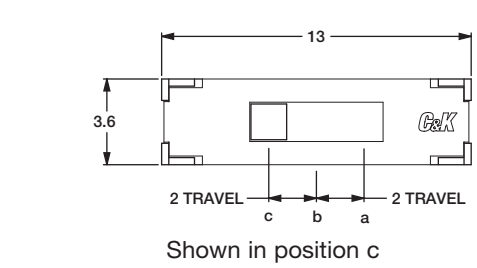

Part Number
JS203011JCQN
DP3T

Shown in position b
Available in tape & reel
only

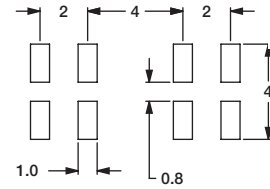
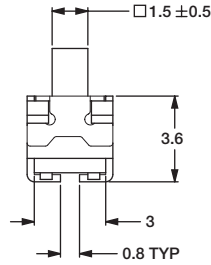
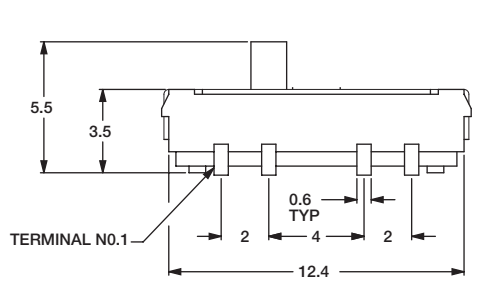

PCB LAYOUT RECOMMENDED

SURFACE MOUNT - J BEND

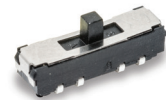
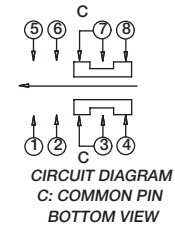
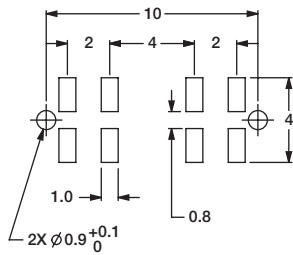
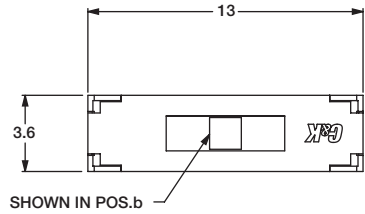

Part Number
JS207011JCQNR
DP3T

Available in tape & reel
only

PC MOUNT - TOLERANCE ±.05

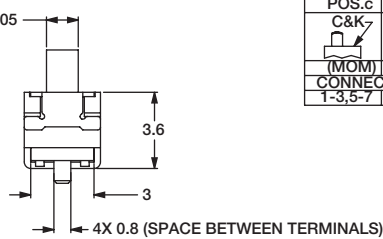
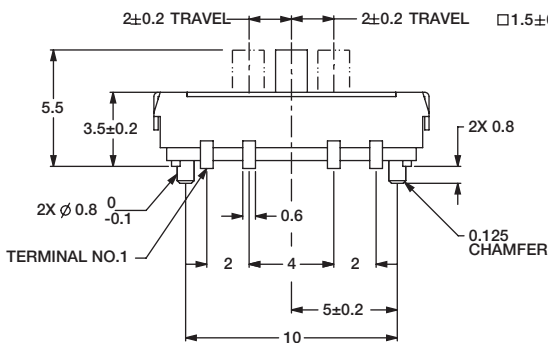

SWITCH FUNCTION		
POS.c	POS.b	POS.a
(MOM)	ON	ON
CONNECTED TERMINALS		
1-3,5-7	2-3,6-7	3-4,7-8

JS Series Sub-Miniature Slide Switches

TAPE AND REEL FOR PART NUMBER JS207011SCQNR, JS207011JCQNR

Quantity per reel 800

PACKING DETAIL 800 PCS

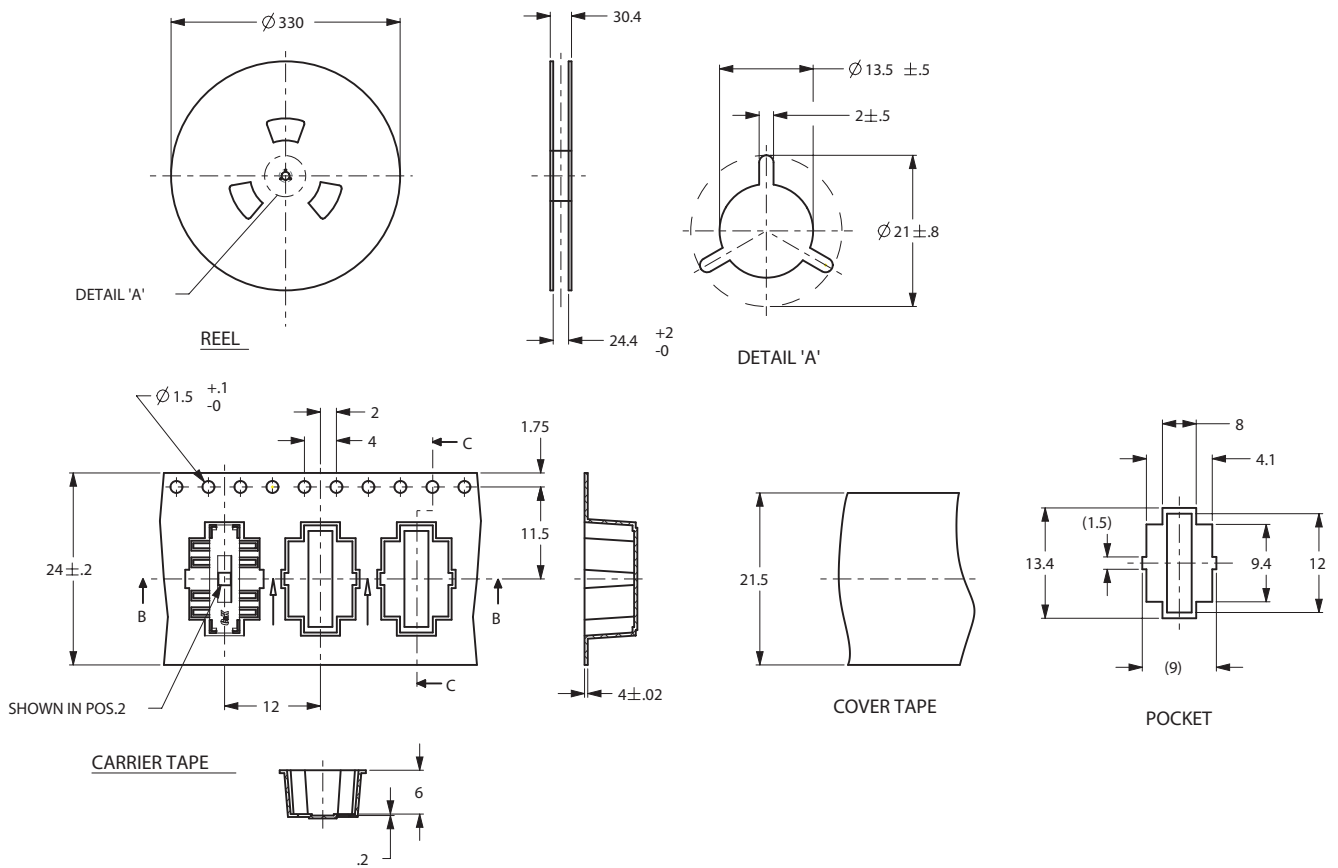

TAPE AND REEL FOR PART NUMBER JS202011SCQN

Quantity per reel 1000

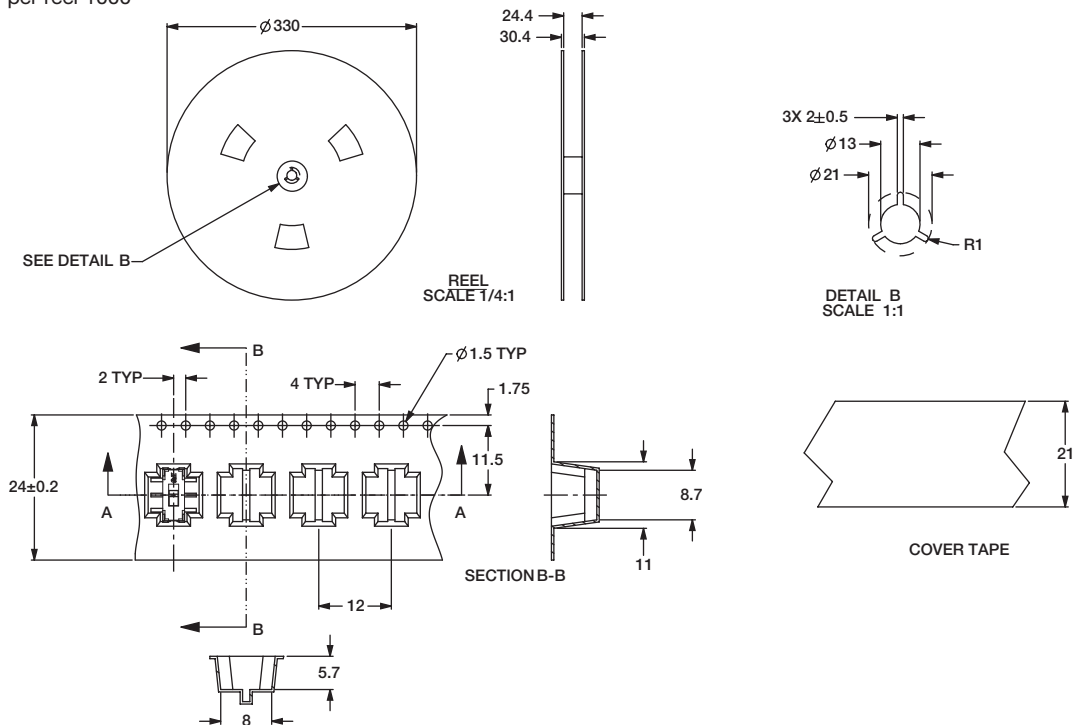

JS Series Sub-Miniature Slide Switches

TAPE AND REEL FOR PART NUMBER JS102011SCQN, JS102011JCQN

Quantity per reel 1000

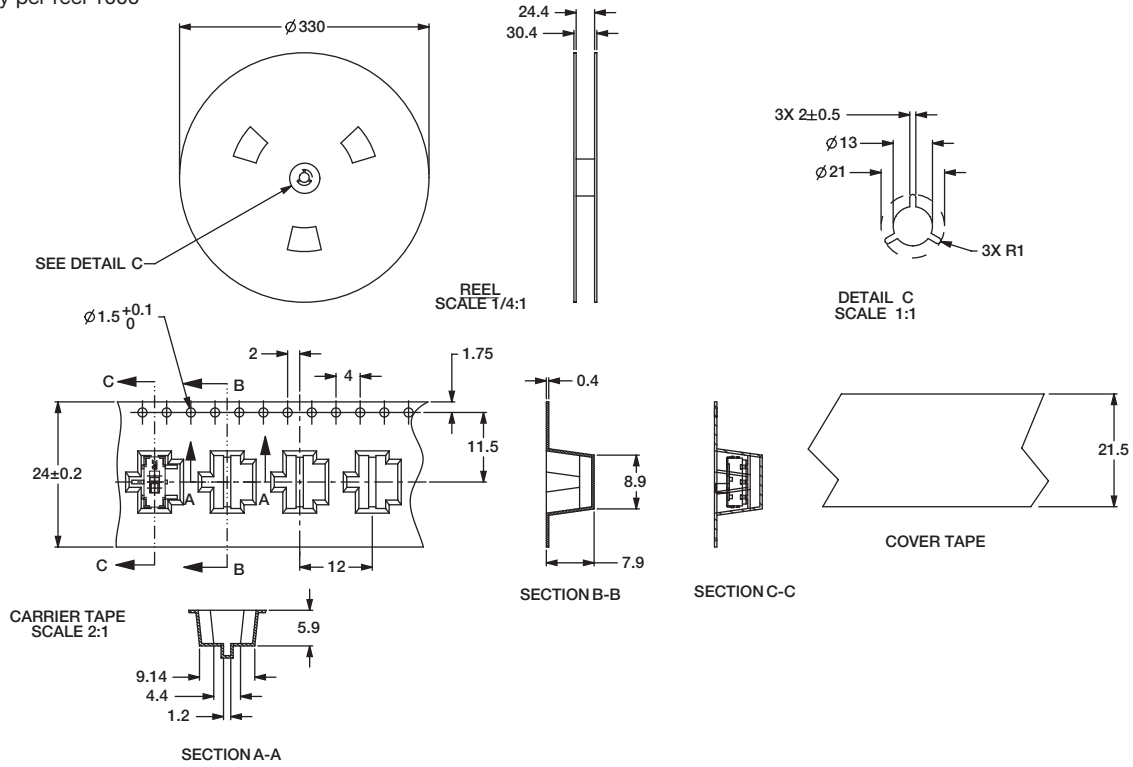

TAPE AND REEL FOR PART NUMBER JS102011SAQN, JS102011JAQN

Quantity per reel 1000

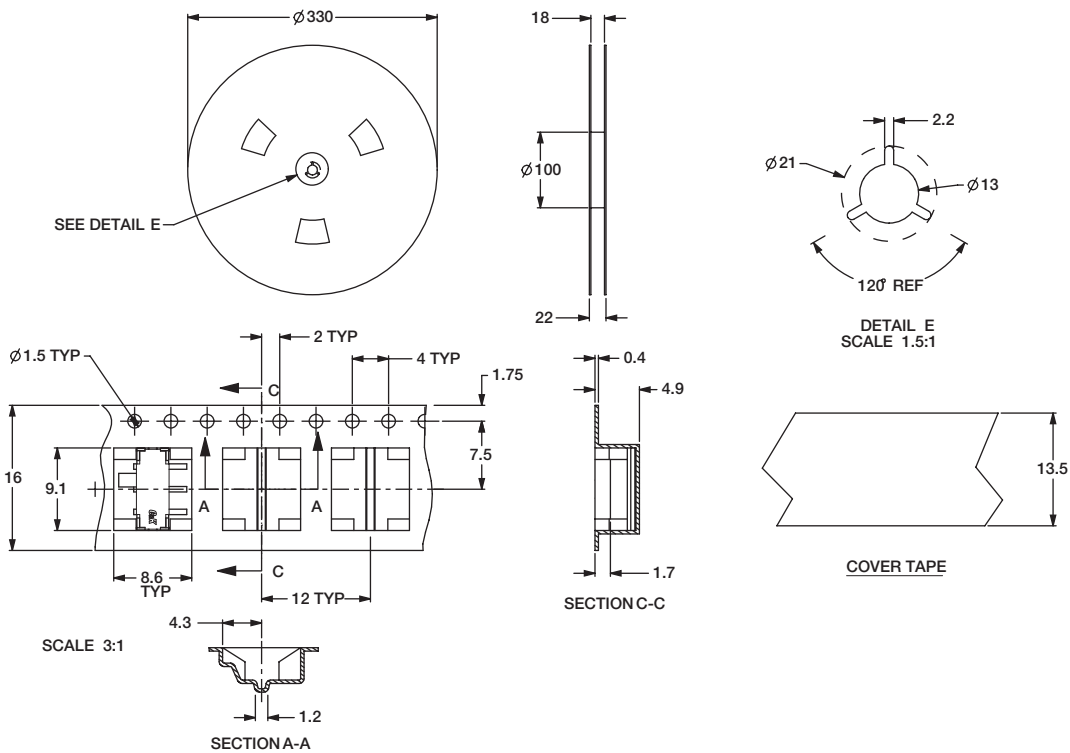

Dimensions are shown: mm
Specifications and dimensions subject to change

JS Series Sub-Miniature Slide Switches

TAPE AND REEL FOR PART NUMBER JS202011JCQN

Quantity per reel 1300

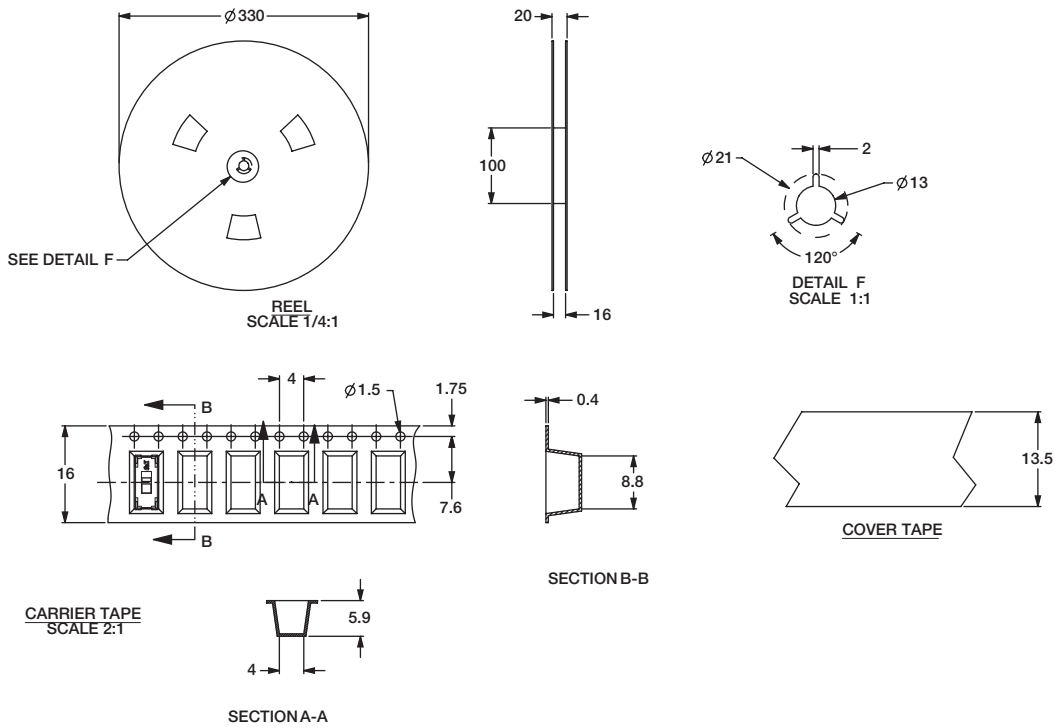

TAPE AND REEL FOR PART NUMBER JS202011JAQN

Quantity per reel 1000

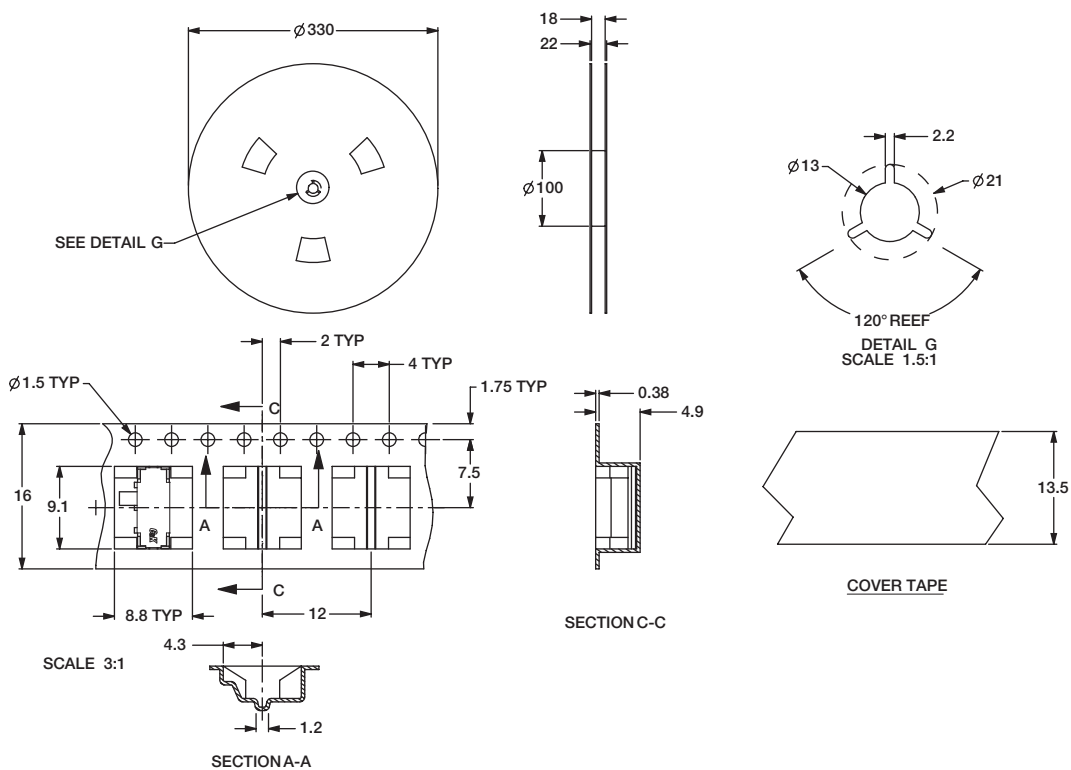

JS Series Sub-Miniature Slide Switches

RIGHT ANGLE SURFACE MOUNT

LOW PROFILE .028±.004 (0.7±0.1) HIGH



Part Number
JS102000SAQN
SPDT

Specifications

CONTACT RATING: 5 VDC @ 1mA

ELECTRICAL LIFE: 15,000 cycles.

CONTACT RESISTANCE: <100 m ohms (initial) <200 m ohms (after processing).

INSULATION RESISTANCE: 100 m ohms @500 VDC.

DIELECTRIC STRENGTH: 250 VAC.

OPERATING TEMPERATURE: -40°C to +85°C

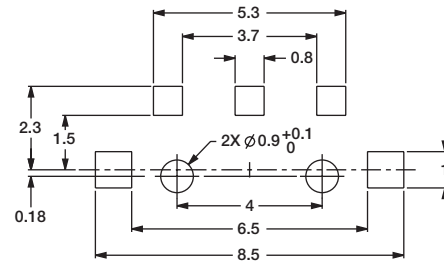
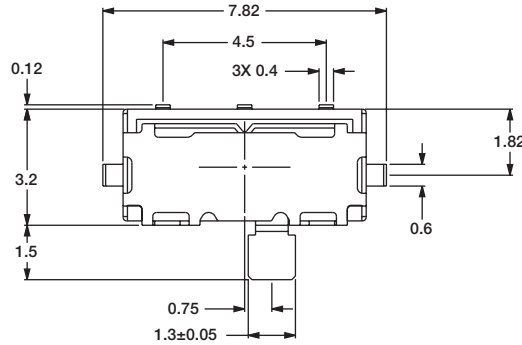

RECOMMENDED PC MOUNTING

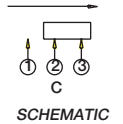
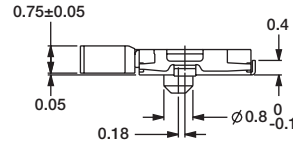
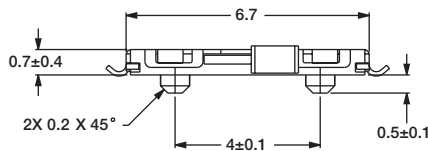

TAPE AND REEL FOR PART NUMBER JS102000SAQN

Quantity per reel 4000

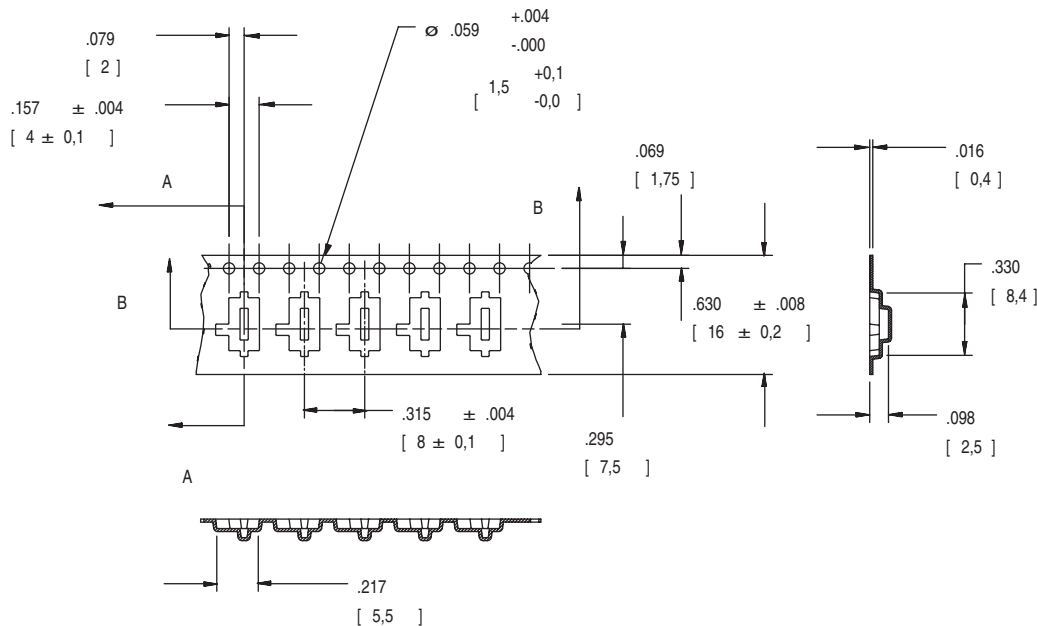

Looking for pricing, stock, or lifecycle information?

Click below to explore more details on WIN SOURCE:

- ⊖ [View JS202011JAQN](#) on WIN SOURCE
- ⊖ [C&K Components](#) Information

Optimize Your Supply Chain with WIN SOURCE Solutions

- ✓ Global Sourcing Solution
- ✓ Obsolete Management
- ✓ Cost Control Management
- ✓ Shortage Management
- ✓ Alternative Solution
- ✓ Excess Inventory Management