



THE DATASHEET OF HMC751LC4





SMT PHEMT LOW NOISE AMPLIFIER, 17 - 27 GHz

Typical Applications

The HMC751LC4 is ideal for:

- Point-to-Point Radios
- Point-to-Multi-Point Radios & VSAT
- Test Equipment and Sensors
- Military

Features

- Noise Figure: 2.2 dB
- Gain: 25 dB
- OIP3: +25 dBm
- Single Supply: +4V @ 73 mA
- 50 Ohm Matched Input/Output
- RoHS Compliant 4 x 4 mm Package

Functional Diagram

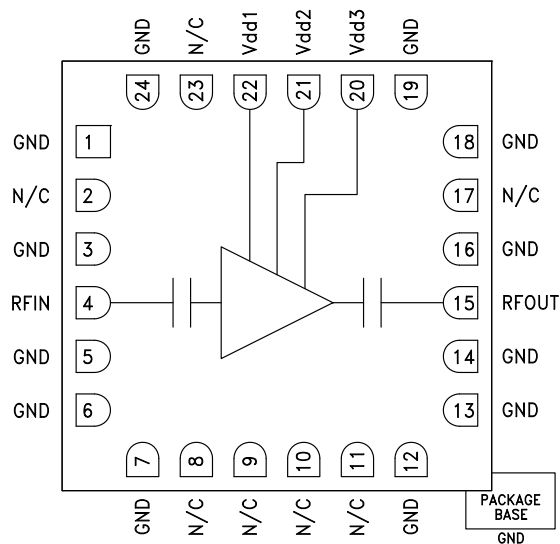

General Description

The HMC751LC4 is a high dynamic range GaAs pHEMT MMIC Low Noise Amplifier (LNA) housed in a leadless “Pb free” RoHS compliant SMT package. The HMC751LC4 provides 25 dB of small signal gain, 2.2 dB of noise figure and output IP3 of +25 dBm. The P1dB output power of +13 dBm also enables the LNA to function as a LO driver for balanced, I/Q or image reject mixers. The HMC751LC4 allows the use of surface mount manufacturing techniques.

Electrical Specifications, $T_A = +25^\circ C$, Vdd 1, 2, 3 = +4V

| Parameter | Min. | Typ. | Max. | Min. | Typ. | Max. | Units |
|--|---------|------|---------|------|------|------|--------|
| Frequency Range | 17 - 20 | | 20 - 27 | | | | GHz |
| Gain | 22 | 24 | | 23 | 25 | | dB |
| Gain Variation Over Temperature | 0.025 | | 0.028 | | | | dB/ °C |
| Noise Figure | 2.2 | | 2.8 | 2.0 | | 2.6 | dB |
| Input Return Loss | 17 | | 15 | | | | dB |
| Output Return Loss | 16 | | 15 | | | | dB |
| Output Power for 1 dB Compression (P1dB) | 13 | | 13 | | | | dBm |
| Saturated Output Power (P _{sat}) | 15 | | 15 | | | | dBm |
| Output Third Order Intercept (IP3) | 25 | | 25 | | | | dBm |
| Supply Current (I _{dd})(V _{dd} = +4V) | 50 | 73 | 90 | 50 | 73 | 90 | mA |



SMT PHEMT LOW NOISE AMPLIFIER, 17 - 27 GHz

Gain vs. Temperature

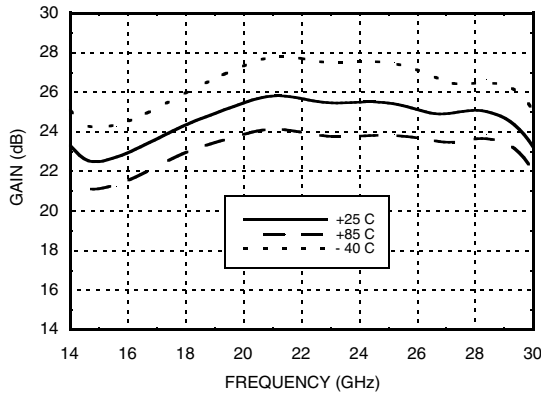

Gain vs. Supply Voltage

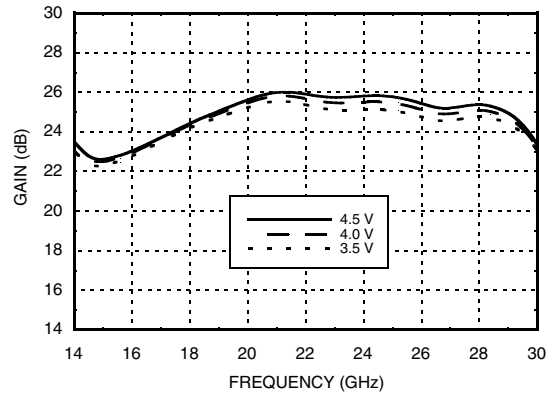

Input Return Loss vs. Temperature

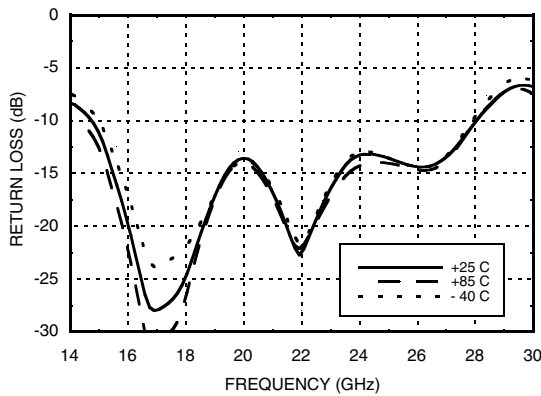

Output Return Loss vs. Temperature

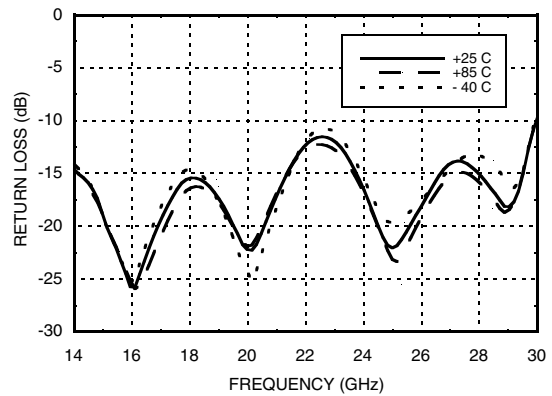

Noise Figure vs. Temperature

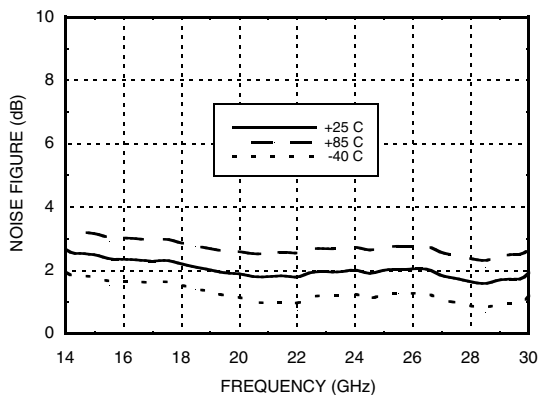

Output IP3 vs. Temperature

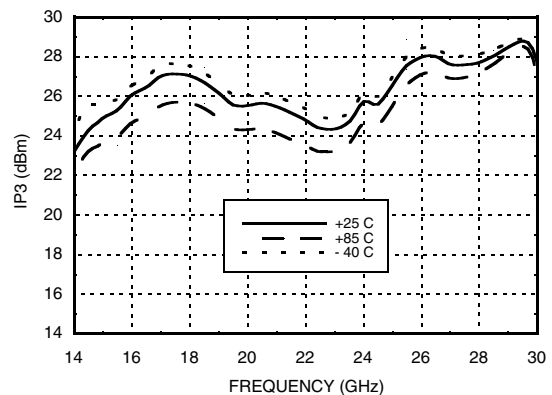

Information furnished by Analog Devices is believed to be accurate and reliable. However, no responsibility is assumed by Analog Devices for its use, nor for any infringements of patents or other rights of third parties that may result from its use. Specifications subject to change without notice. No license is granted by implication or otherwise under any patent or patent rights of Analog Devices. Trademarks and registered trademarks are the property of their respective owners.

For price, delivery, and to place orders: Analog Devices, Inc., One Technology Way, P.O. Box 9106, Norwood, MA 02062-9106 Phone: 781-329-4700 • Order online at www.analog.com Application Support: Phone: 1-800-ANALOG-D



SMT PHEMT LOW NOISE AMPLIFIER, 17 - 27 GHz

P1dB vs. Temperature

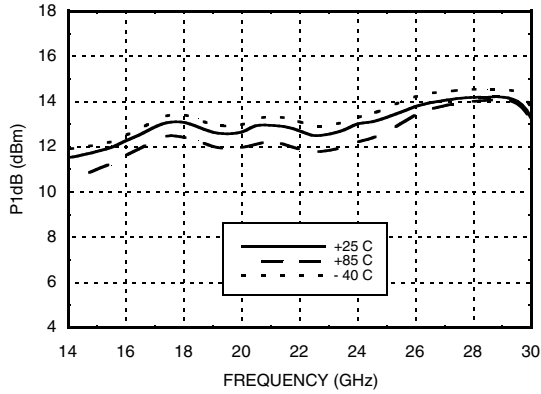

P1dB vs. Supply Voltage

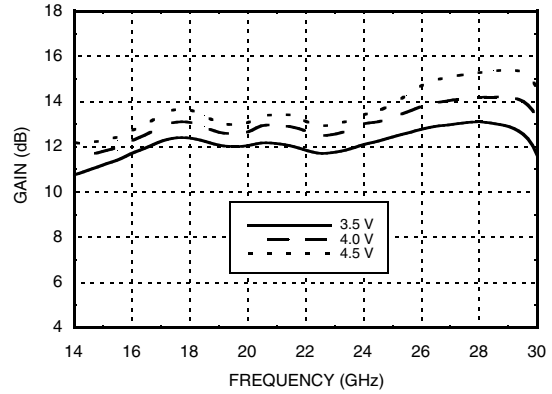

Psat vs. Temperature

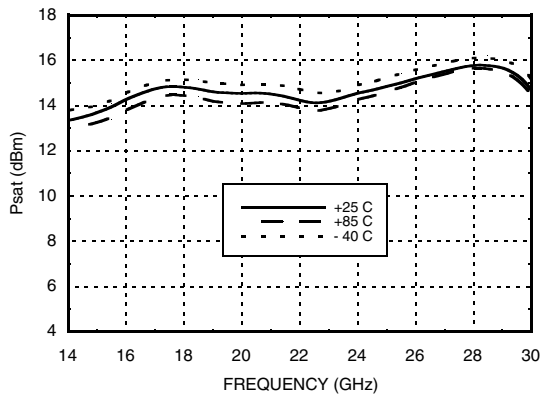

Reverse Isolation vs. Temperature

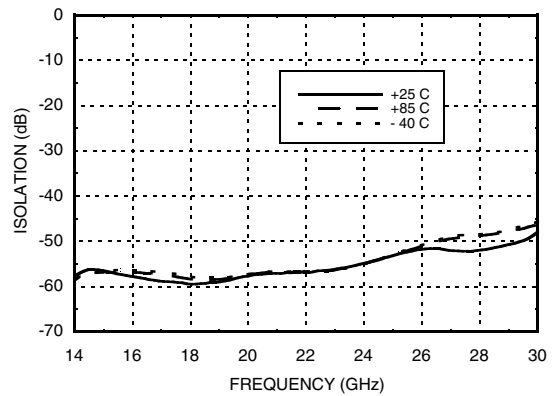

Power Compression @ 21 GHz

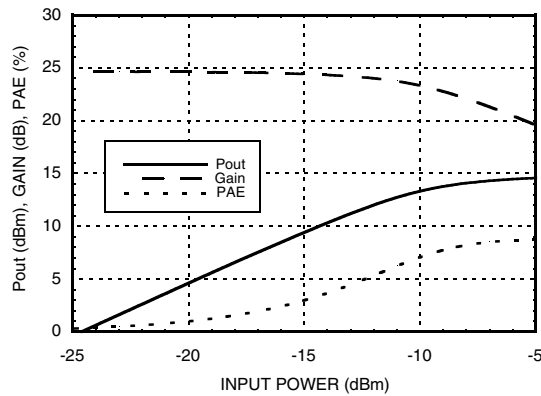

Information furnished by Analog Devices is believed to be accurate and reliable. However, no responsibility is assumed by Analog Devices for its use, nor for any infringements of patents or other rights of third parties that may result from its use. Specifications subject to change without notice. No license is granted by implication or otherwise under any patent or patent rights of Analog Devices. Trademarks and registered trademarks are the property of their respective owners.

For price, delivery, and to place orders: Analog Devices, Inc., One Technology Way, P.O. Box 9106, Norwood, MA 02062-9106 Phone: 781-329-4700 • Order online at www.analog.com Application Support: Phone: 1-800-ANALOG-D



SMT PHEMT LOW NOISE AMPLIFIER, 17 - 27 GHz

Absolute Maximum Ratings

| | |
|--|----------------|
| Drain Bias Voltage (Vdd1, Vdd2, Vdd3) | +5.5 Vdc |
| RF Input Power (RFIN)(Vdd = +4 Vdc) | -5 dBm |
| Channel Temperature | 175 °C |
| Continuous P _{diss} (T= 85 °C) (derate 11.2 mW/°C above 85 °C) | 1 W |
| Thermal Resistance (channel to ground paddle) | 89 °C/W |
| Storage Temperature | -65 to +150 °C |
| Operating Temperature | -40 to +85 °C |

Typical Supply Current vs. Vdd

| Vdd (Vdc) | I _{dd} (mA) |
|-----------|----------------------|
| +3.5 | 69 |
| +4.0 | 73 |
| +4.5 | 77 |

Note: Amplifier will operate over full voltage range shown above.



ELECTROSTATIC SENSITIVE DEVICE
OBSERVE HANDLING PRECAUTIONS

Outline Drawing

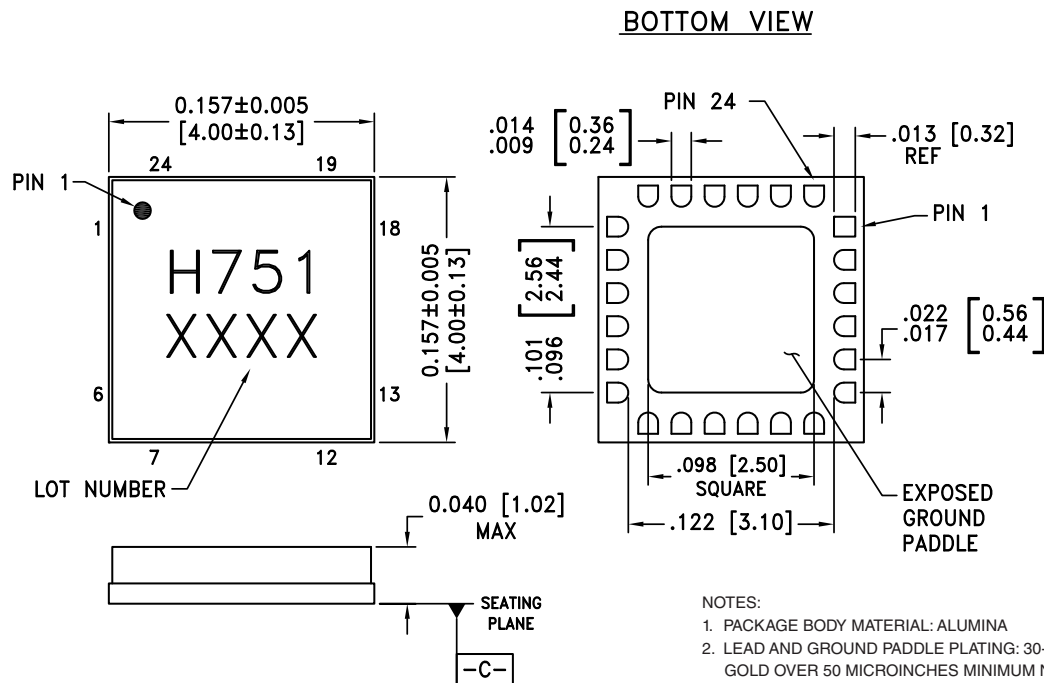

NOTES:

- PACKAGE BODY MATERIAL: ALUMINA
- LEAD AND GROUND PADDLE PLATING: 30-80 MICROINCHES GOLD OVER 50 MICROINCHES MINIMUM NICKEL
- DIMENSIONS ARE IN INCHES [MILLIMETERS]
- LEAD SPACING TOLERANCE IS NON-CUMULATIVE
- PACKAGE WARP SHALL NOT EXCEED 0.05mm DATUM
- ALL GROUND LEADS AND GROUND PADDLE MUST BE SOLDERED TO PCB RF GROUND

Package Information

| Part Number | Package Body Material | Lead Finish | MSL Rating | Package Marking ^[2] |
|-------------|-----------------------|------------------|---------------------|--------------------------------|
| HMC751LC4 | Alumina, White | Gold over Nickel | MSL3 ^[1] | H751 XXXX |

[1] Max peak reflow temperature of 260 °C

[2] 4-Digit lot number XXXX



SMT PHEMT LOW NOISE AMPLIFIER, 17 - 27 GHz

Pin Descriptions

| Pin Number | Function | Description | Interface Schematic |
|--------------------------------------|------------|---|---------------------|
| 1, 3, 5 - 7, 12 - 14, 16, 18, 19, 24 | GND | These pins and package bottom must be connected to RF/DC ground. | |
| 2, 8 - 11, 17, 23 | N/C | This pin may be connected to RF/DC ground. Performance will not be affected. | |
| 4 | RFIN | This pin is AC coupled and matched to 50 Ohms. | |
| 15 | RFOUT | This pin is AC coupled and matched to 50 Ohms. | |
| 22, 21, 20 | Vdd1, 2, 3 | Power Supply Voltage for the amplifier. External bypass capacitors of 100 pF, 1,000 pF and 2.2 μF are required. | |

Application Circuit

| Component | Value |
|------------|----------|
| C1, C2, C3 | 100 pF |
| C4, C5, C6 | 1,000 pF |
| C7, C8, C9 | 2.2 μF |

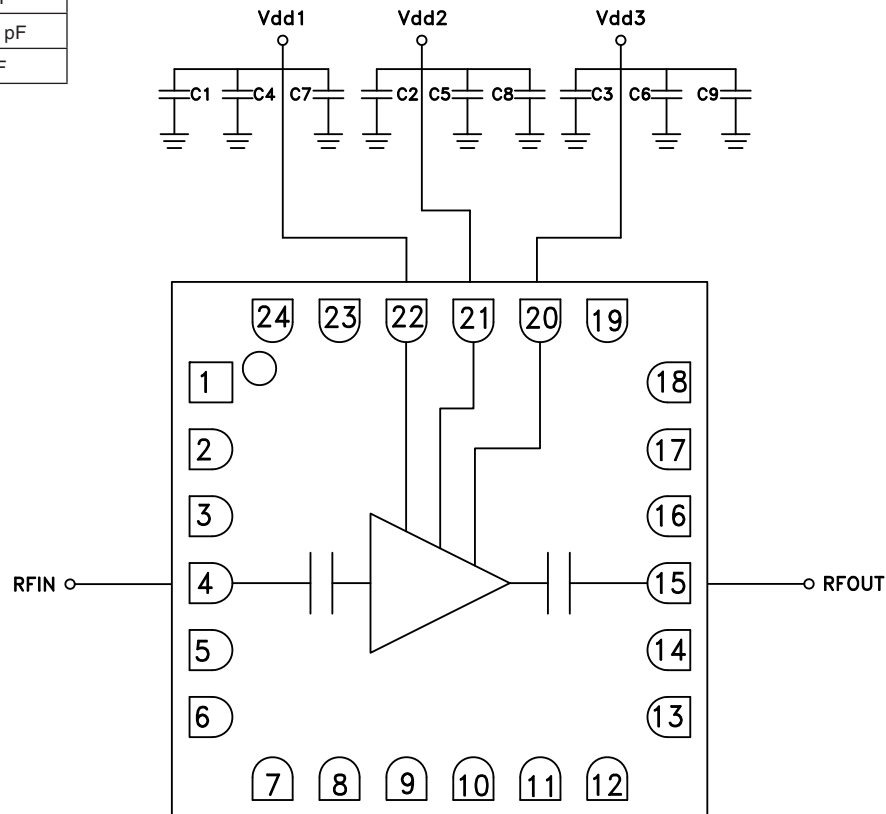

Information furnished by Analog Devices is believed to be accurate and reliable. However, no responsibility is assumed by Analog Devices for its use, nor for any infringements of patents or other rights of third parties that may result from its use. Specifications subject to change without notice. No license is granted by implication or otherwise under any patent or patent rights of Analog Devices. Trademarks and registered trademarks are the property of their respective owners.

For price, delivery, and to place orders: Analog Devices, Inc., One Technology Way, P.O. Box 9106, Norwood, MA 02062-9106 Phone: 781-329-4700 • Order online at www.analog.com Application Support: Phone: 1-800-ANALOG-D

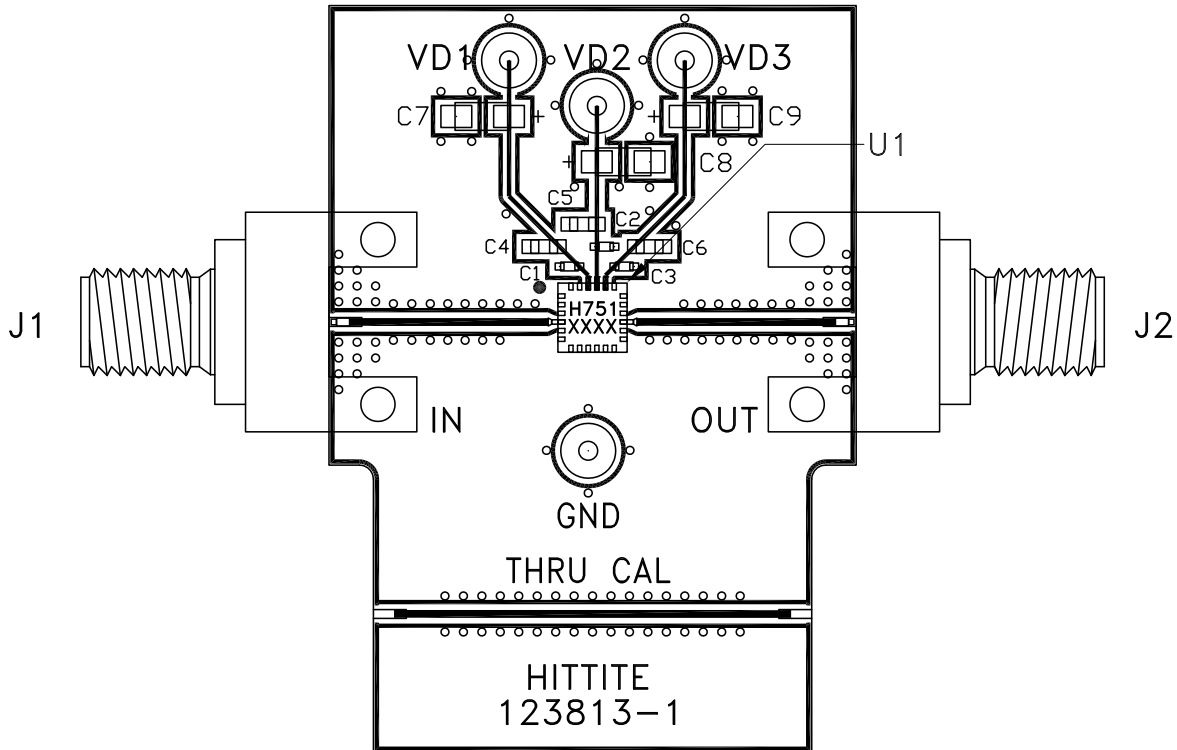
**SMT PHEMT LOW NOISE
AMPLIFIER, 17 - 27 GHz**
Evaluation PCB

List of Materials for Evaluation PCB 123815 [1]

| Item | Description |
|---------|---------------------------------|
| J1 - J2 | PCB Mount K Connector |
| J3 - J6 | DC Pin |
| C1 - C3 | 100 pF Capacitor, 0402 Pkg. |
| C4 - C6 | 1,000 pF Capacitor, 0603 Pkg. |
| C7 - C9 | 2.2 μ F Capacitor, Tantalum |
| U1 | HMC751LC4 Amplifier |
| PCB [2] | 123813 Evaluation PCB |

[1] Reference this number when ordering complete evaluation PCB

[2] Circuit Board Material: Rogers 4350 or Arlon 25FR

The circuit board used in the application should use RF circuit design techniques. Signal lines should have 50 Ohm impedance while the package ground leads and exposed paddle should be connected directly to the ground plane similar to that shown. A sufficient number of via holes should be used to connect the top and bottom ground planes. The evaluation board should be mounted to an appropriate heat sink. The evaluation circuit board shown is available from Hittite upon request.

Looking for pricing, stock, or lifecycle information?

Click below to explore more details on WIN SOURCE:

 [View HMC751LC4 on WIN SOURCE](#)

 [Analog Devices Inc. Information](#)

Optimize Your Supply Chain with WIN SOURCE Solutions

-  Global Sourcing Solution
-  Obsolete Management
-  Cost Control Management
-  Shortage Management
-  Alternative Solution
-  Excess Inventory Management