



**THE DATASHEET OF
MAX4486ASA**



Click [here](#) to ask about the production status of specific part numbers.

MAX4484/MAX4486/ MAX4487

Single/Dual/Quad, Low-Cost, Single-Supply 7MHz, Rail-to-Rail Op Amps

General Description

The MAX4484/MAX4486/MAX4487 single/dual/quad low-cost general-purpose op amps operate from a single +2.7V to +5.5V supply. The op amps are unity-gain stable with a 7MHz gain-bandwidth product, capable of driving an external 2kΩ load with rail-to-rail output swing. The amplifiers are stable with capacitive loads of up to 100pF. The MAX4484/MAX4486/MAX4487 are specified from -40°C to +125°C, making them suitable for a variety of harsh environments.

The single MAX4484 is available in the ultra-small 5-pin SC70, while the dual MAX4486 is packaged in the space-saving 8-pin SOT23 and μMAX® packages. The quad MAX4487 is available in the 14-pin SO and TSSOP packages.

Applications

- Single-Supply Zero-Crossing Detector
- Instruments and Terminals
- Portable Communicators
- Electronic Ignition Modules
- Infrared Receivers for Remote Controls
- Sensor Signal Detection

μMAX is a registered trademark of Maxim Integrated Products, Inc..

Pin Configurations/Functional Diagrams

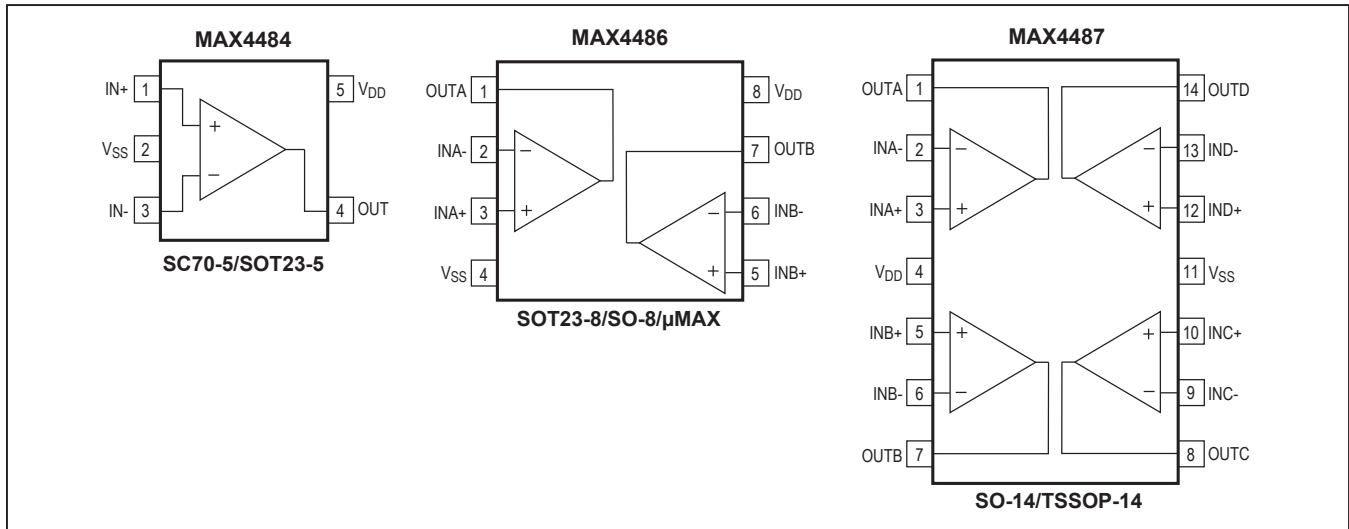

Features

- 7MHz Unity-Gain Stable Bandwidth
- Stable for Capacitive Loads Up to 100pF
- +2.7V to +5.5V Single-Supply Voltage Range
- Ground-Sensing Inputs
- Outputs Swing Rail-to-Rail
- No Phase Reversal for Overdriven Inputs
- 85dB AVOL with 2kΩ Load
- 0.01% THD with 2kΩ Load
- Available in Space-Saving Packages
 - 5-Pin SC70 (MAX4484)
 - 8-Pin SOT23 (MAX4486)

Ordering Information

| PART | TEMP RANGE | PIN-PACKAGE | TOP MARK |
|--------------|-----------------|-------------|----------|
| MAX4484AXK-T | -40°C to +125°C | 5 SC70-5 | ABQ |
| MAX4484AUK-T | -40°C to +125°C | 5 SOT23-5 | ADPE |
| MAX4486ASA | -40°C to +125°C | 8 SO | — |
| MAX4486AUA | -40°C to +125°C | 8 μMAX | — |
| MAX4487AUD | -40°C to +125°C | 14 TSSOP | — |
| MAX4487ASD | -40°C to +125°C | 14 SO | — |

Absolute Maximum Ratings

| | | | |
|-------------------------------------------------------------------------------|--------------------------------------------|----------------------------------------------------|-----------------|
| Power Supply Voltage (V_{DD} to V_{SS})..... | -0.3V to +6V | 8-Pin μ MAX (derate 4.5mW/°C above +70°C)..... | 362mW |
| All Other Pins | ($V_{SS} - 0.3V$) to ($V_{DD} + 0.3V$) | 14-Pin TSSOP (derate 9.1mW/°C above +70°C)..... | 727mW |
| Output Short-Circuit Duration (OUT shorted to V_{DD} or V_{SS}) | Continuous | 14-Pin SO (derate 8.33mW/°C above +70°C)..... | 667mW |
| Continuous Power Dissipation ($T_A = +70^\circ\text{C}$) | | Operating Temperature Range..... | -55°C to +125°C |
| 5-Pin SC70 (derate 3.1mW/°C above +70°C)..... | 247mW | Junction Temperature..... | +150°C |
| 5-Pin SOT23 (derate 7.1mW/°C above +70°C) | 571mW | Storage Temperature Range..... | -65°C to +150°C |
| 8-Pin SOT23 (derate 9.1mW/°C above +70°C) | 727mW | Lead Temperature (soldering, 10s) | +300°C |
| 8-Pin SO (derate 5.88mW/°C above +70°C)..... | 471mW | | |

Stresses beyond those listed under "Absolute Maximum Ratings" may cause permanent damage to the device. These are stress ratings only, and functional operation of the device at these or any other conditions beyond those indicated in the operational sections of the specifications is not implied. Exposure to absolute maximum rating conditions for extended periods may affect device reliability.

Electrical Characteristics— $T_A = +25^\circ\text{C}$

($V_{DD} = +5.0V$, $V_{SS} = 0V$, $V_{CM} = 0V$, $V_{OUT} = V_{DD}/2$, $R_L = \infty$ to $V_{DD}/2$, unless otherwise noted.)

| PARAMETER | SYMBOL | CONDITIONS | MIN | TYP | MAX | UNITS |
|---------------------------------|-----------|--------------------------------------------------------------------|--------------------|-----------|----------------|------------|
| Supply Voltage Range | V_{DD} | Inferred from PSRR test | 2.7 | | 5.5 | V |
| Supply Current per Amplifier | I_{DD} | $V_{DD} = +2.7V$ | | 1.9 | | mA |
| | | $V_{DD} = +5.0V$ | | 2.2 | 3.5 | |
| Input Offset Voltage | V_{OS} | MAX4484 | | ± 0.3 | ± 5.0 | mV |
| | | MAX4486 | | ± 0.3 | ± 7.0 | |
| | | MAX4487 | | ± 0.3 | ± 9.0 | |
| Input Bias Current | I_B | (Note 1) | | ± 0.1 | 100 | pA |
| Input Offset Current | I_{OS} | (Note 1) | | ± 0.1 | 100 | pA |
| Input Resistance | R_{IN} | Differential or common mode | | 1000 | | G Ω |
| Input Common-Mode Voltage Range | V_{CM} | Inferred from CMRR test | V_{SS} | | $V_{DD} - 1.3$ | V |
| Common-Mode Rejection Ratio | CMRR | $V_{SS} \leq V_{CM} \leq V_{DD} - 1.3V$ | 67 | 83 | | dB |
| Power-Supply Rejection Ratio | PSRR | $+2.7V \leq V_{DD} \leq +5.5V$ | 70 | 85 | | dB |
| Large-Signal Voltage Gain | A_{VOL} | $V_{SS} + 0.3V \leq V_{OUT} \leq V_{DD} - 0.3V$, $R_L = 1k\Omega$ | $R_L = 100k\Omega$ | | 98 | dB |
| | | | $R_L = 2k\Omega$ | 76 | 85 | |
| Output Voltage High | V_{OH} | Specified as $ V_{DD} - V_{OH} $ | $R_L = 100k\Omega$ | | 3 | mV |
| | | | $R_L = 2k\Omega$ | | 15 | |
| Output Voltage Low | V_{OL} | Specified as $ V_{OL} - V_{SS} $ | $R_L = 100k\Omega$ | | 1 | mV |
| | | | $R_L = 2k\Omega$ | | 20 | |
| Output Short-Circuit Current | I_{SC} | Sourcing | | 27 | | mA |
| | | Sinking | | 33 | | |
| Gain-Bandwidth Product | GBW | | | 7 | | MHz |
| Phase Margin | ϕ_m | | | 55 | | degrees |
| Gain Margin | Gm | | | 12 | | dB |
| Slew Rate | SR | | | 20 | | V/ μ s |

Electrical Characteristics— $T_A = +25^\circ\text{C}$

($V_{DD} = +5.0\text{V}$, $V_{SS} = 0\text{V}$, $V_{CM} = 0\text{V}$, $V_{OUT} = V_{DD}/2$, $R_L = \infty$ to $V_{DD}/2$, unless otherwise noted.)

| PARAMETER | SYMBOL | CONDITIONS | MIN | TYP | MAX | UNITS |
|-----------------------------|------------|---------------------------------------------------------------------|---------------------------|-------|-----|------------------------------|
| Input Voltage-Noise Density | e_n | $f = 10\text{kHz}$ | | 29 | | $\text{nV}/\sqrt{\text{Hz}}$ |
| Input Current-Noise Density | i_n | $f = 10\text{kHz}$ | | 1 | | $\text{fA}/\sqrt{\text{Hz}}$ |
| Capacitive-Load Stability | C_{LOAD} | $A_V = +1\text{V/V}$ (Note 1) | 100 | | | pF |
| Power-On Time | t_{ON} | | | 1 | | μs |
| Input Capacitance | C_{IN} | | | 2 | | pF |
| Total Harmonic Distortion | THD | $f = 10\text{kHz}$, $V_{OUT} = 2V_{P-P}$, $A_V = +1\text{V/V}$ | $R_L = 100\text{k}\Omega$ | 0.006 | | % |
| | | | $R_L = 2\text{k}\Omega$ | 0.01 | | |
| Settling Time to 0.01% | t_S | $V_{OUT} = 4\text{V}$ step, $A_V = +1\text{V/V}$ | | 450 | | ns |

Electrical Characteristics— $T_A = -40^\circ\text{C}$ to $+125^\circ\text{C}$

($V_{DD} = +5.0\text{V}$, $V_{SS} = 0\text{V}$, $V_{CM} = 0\text{V}$, $V_{OUT} = V_{DD}/2$, $R_L = \infty$ to $V_{DD}/2$, unless otherwise noted.) (Note 2)

| PARAMETER | SYMBOL | CONDITIONS | MIN | TYP | MAX | UNITS |
|---------------------------------|------------|-----------------------------------------------------------------------------------------|---------------------------------------------------|---------|----------------|------------------------------|
| Supply Voltage Range | V_{DD} | Inferred from PSRR test | 2.7 | | 5.5 | V |
| Supply Current per Amplifier | I_{DD} | | | | 4.0 | mA |
| Input Offset Voltage | V_{OS} | MAX4484 | | | ± 8.5 | mV |
| | | MAX4486 | | | ± 10.0 | |
| | | MAX4487 | | | ± 11.0 | |
| Input Offset Voltage Drift | TC_{VOS} | | | ± 6 | | $\mu\text{V}/^\circ\text{C}$ |
| Input Bias Current | I_B | (Note 1) | | | ± 100 | pA |
| Input Offset Current | I_{OS} | (Note 1) | | | ± 100 | pA |
| Input Common-Mode Voltage Range | V_{CM} | Inferred from CMRR test | V_{SS} | | $V_{DD} - 1.4$ | V |
| Common-Mode Rejection Ratio | CMRR | $V_{SS} \leq V_{CM} \leq V_{DD} - 1.4\text{V}$ | $T_A = -40^\circ\text{C}$ to $+85^\circ\text{C}$ | 65 | | dB |
| | | | $T_A = -40^\circ\text{C}$ to $+125^\circ\text{C}$ | 62 | | |
| Power-Supply Rejection Ratio | PSRR | $+2.7\text{V} \leq V_{DD} \leq +5.5\text{V}$ | $T_A = -40^\circ\text{C}$ to $+85^\circ\text{C}$ | 67 | | dB |
| | | | $T_A = -40^\circ\text{C}$ to $+125^\circ\text{C}$ | 64 | | |
| Large-Signal Voltage Gain | A_{VOL} | $V_{SS} + 0.3\text{V} \leq V_{OUT} \leq V_{DD} - 0.3\text{V}$, $R_L = 2\text{k}\Omega$ | $T_A = -40^\circ\text{C}$ to $+85^\circ\text{C}$ | 66 | | dB |
| | | | $T_A = -40^\circ\text{C}$ to $+125^\circ\text{C}$ | 62 | | |
| Output Voltage High | V_{OH} | $ V_{DD} - V_{OUT} $, $R_L = 2\text{k}\Omega$ | $T_A = -40^\circ\text{C}$ to $+85^\circ\text{C}$ | 100 | | mV |
| | | | $T_A = -40^\circ\text{C}$ to $+125^\circ\text{C}$ | 100 | | |
| Output Voltage Low | V_{OL} | $ V_{OUT} - V_{SS} $, $R_L = 2\text{k}\Omega$ | $T_A = -40^\circ\text{C}$ to $+85^\circ\text{C}$ | 100 | | mV |
| | | | $T_A = -40^\circ\text{C}$ to $+125^\circ\text{C}$ | 250 | | |

Note 1: Guaranteed by design.

Note 2: Specifications are 100% tested at $T_A = +25^\circ\text{C}$ (exceptions marked). All temperature limits are guaranteed by design.

Typical Operating Characteristics

($V_{DD} = +5V$, $V_{SS} = 0V$, $V_{CM} = V_{DD}/2$, $R_L = \infty$ to $V_{DD}/2$, unless otherwise noted.)

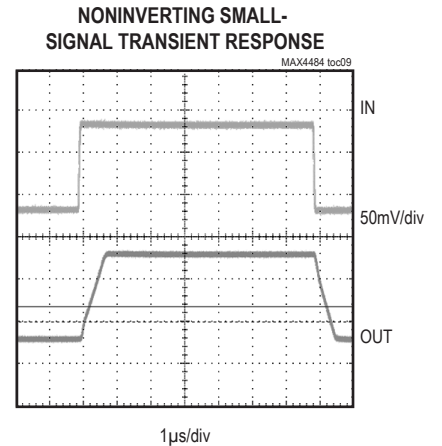
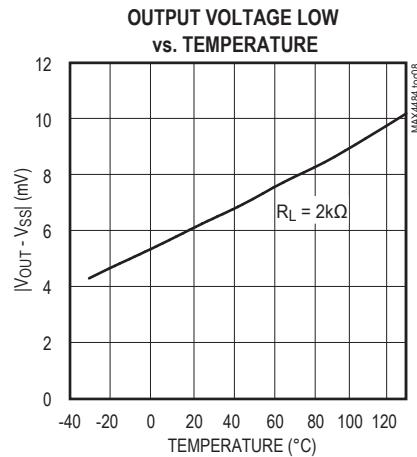
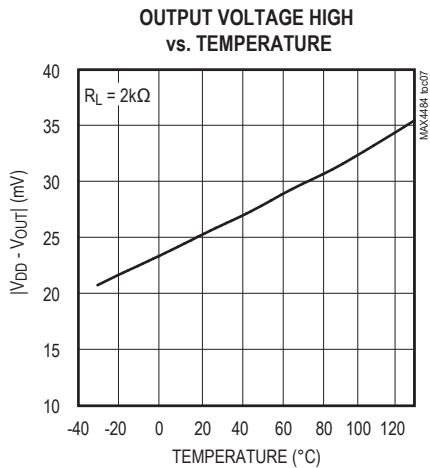
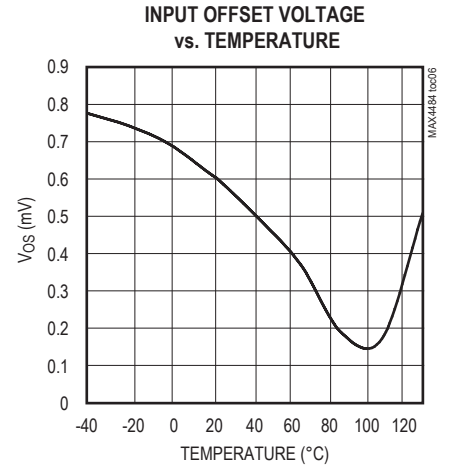
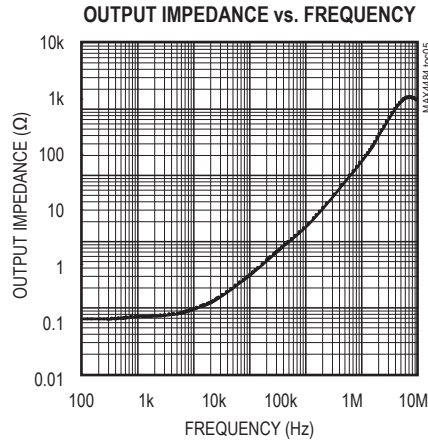
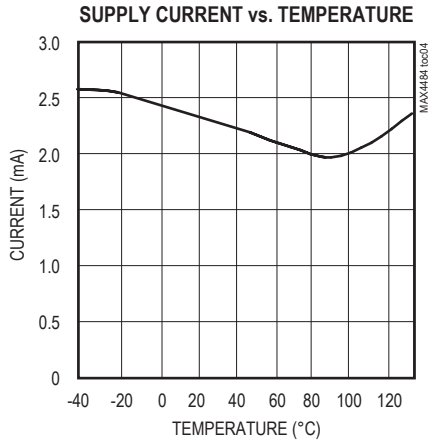
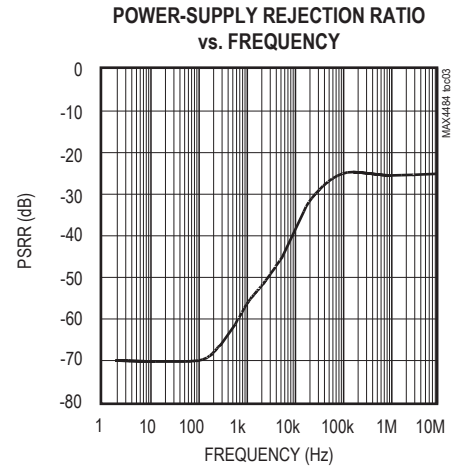
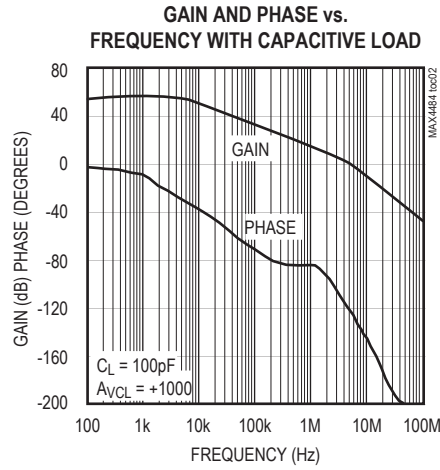
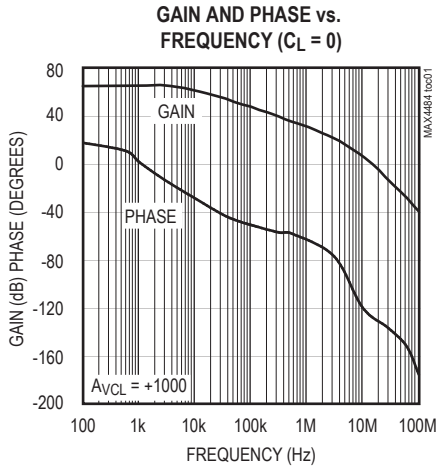

Typical Operating Characteristics (continued)

($V_{DD} = +5V$, $V_{SS} = 0V$, $V_{CM} = V_{DD}/2$, $R_L = \infty$ to $V_{DD}/2$, unless otherwise noted.)

NONINVERTING LARGE-SIGNAL
TRANSIENT RESPONSE

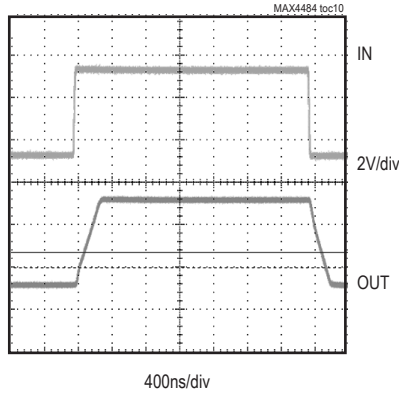

PERCENT OVERSHOOT
vs. CAPACITIVE LOAD

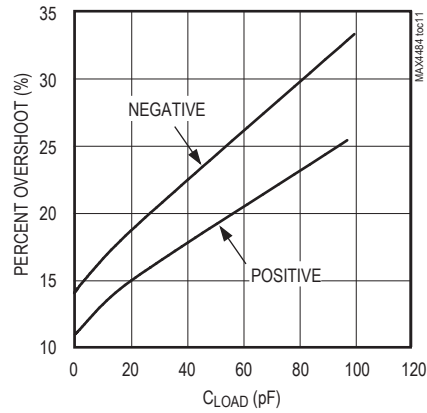

LARGE-SIGNAL GAIN
vs. OUTPUT VOLTAGE LOW

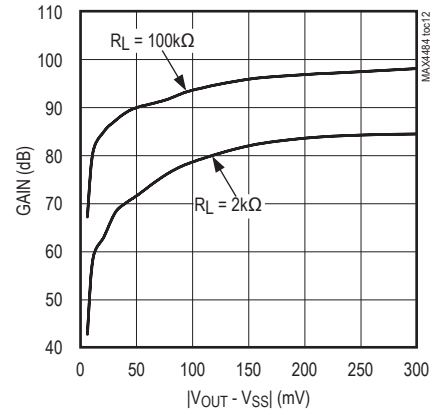

LARGE-SIGNAL GAIN
vs. OUTPUT VOLTAGE HIGH

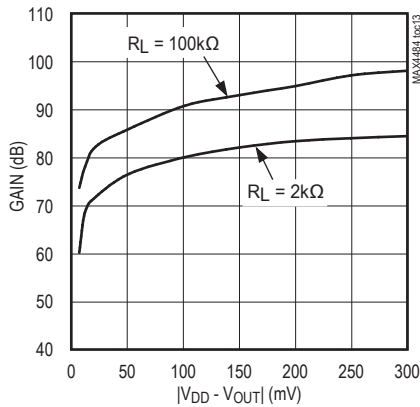

CROSSTALK vs. FREQUENCY

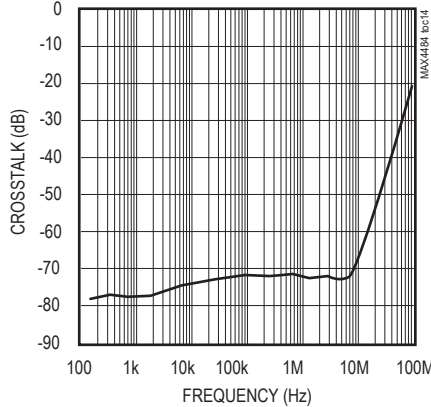

POWER-SUPPLY REJECTION RATIO
vs. OPERATING VOLTAGE

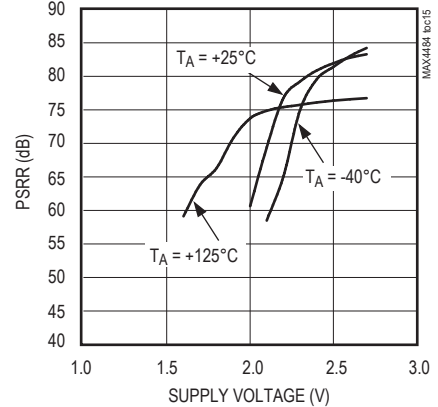

TOTAL HARMONIC DISTORTION
PLUS NOISE vs. FREQUENCY

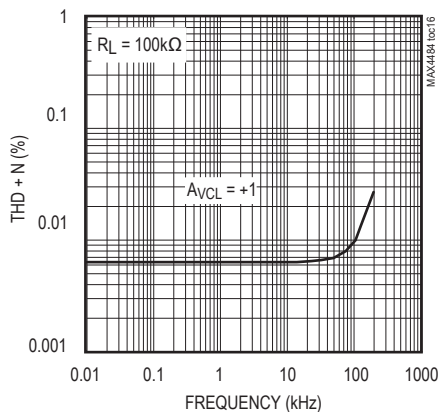

TOTAL HARMONIC DISTORTION
PLUS NOISE vs. AMPLITUDE

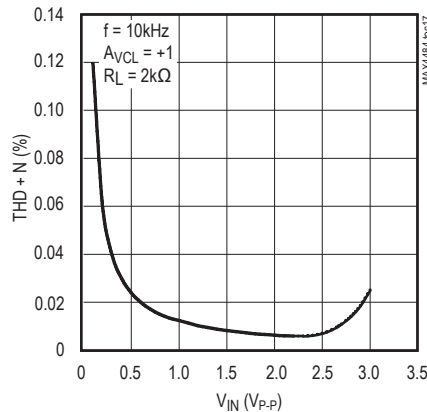

TOTAL HARMONIC DISTORTION
PLUS NOISE vs. AMPLITUDE

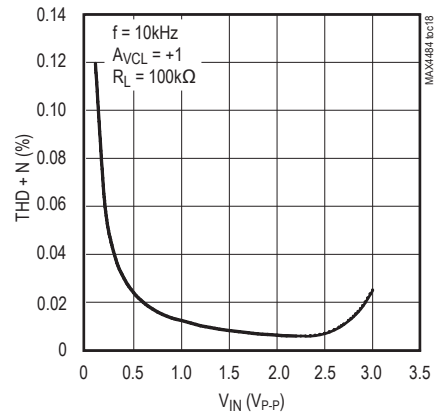

Pin Description

| PIN | | | NAME | FUNCTION |
|---------|---------|---------|-----------------|------------------------------------------|
| MAX4484 | MAX4486 | MAX4487 | | |
| 3 | — | — | IN- | Inverting Amplifier Input |
| 1 | — | — | IN+ | Noninverting Amplifier Input |
| 4 | — | — | OUT | Amplifier Output |
| — | 2 | 2 | INA- | Inverting Amplifier Input (Channel A) |
| — | 3 | 3 | INA+ | Noninverting Amplifier Input (Channel A) |
| — | 1 | 1 | OUTA | Amplifier Output (Channel A) |
| — | 6 | 6 | INB- | Inverting Amplifier Input (Channel B) |
| — | 5 | 5 | INB+ | Noninverting Amplifier Input (Channel B) |
| — | 7 | 7 | OUTB | Amplifier Output (Channel B) |
| — | — | 9 | INC- | Inverting Amplifier Input (Channel C) |
| — | — | 10 | INC+ | Noninverting Amplifier Input (Channel C) |
| — | — | 8 | OUTC | Amplifier Output (Channel C) |
| — | — | 13 | IND- | Inverting Amplifier Input (Channel D) |
| — | — | 12 | IND+ | Noninverting Amplifier Input (Channel D) |
| — | — | 14 | OUTD | Amplifier Output (Channel D) |
| 2 | 4 | 11 | V _{SS} | Negative Power-Supply Voltage |
| 5 | 8 | 4 | V _{DD} | Positive Power-Supply Voltage |

Detailed Description

Rail-to-Rail Output Stage

The MAX4484/MAX4486/MAX4487 can drive a 2kΩ load and still swing within 50mV of the supply rails. Figure 1 shows the output swing of the MAX4484 configured with $A_V = +1V/V$.

Driving Capacitive Loads

Driving a capacitive load can cause instability in many op amps, especially those with low quiescent current. The MAX4484/MAX4486/MAX4487 are unity-gain stable for a range of capacitive loads up to 100pF. Figure 2 shows the response of the MAX4484 with an excessive capacitive load. Adding a series resistor between the output and the load capacitor (Figure 3) improves the circuit's response by isolating the load capacitance from the op amp's output.

Applications Information

Power Supplies and Layout

The MAX4484/MAX4486/MAX4487 operate from a single +2.7V to +5.5V power supply. Bypass the power supply with 0.1μF capacitor to ground. Good layout techniques optimize performance by decreasing the amount of stray capacitance at the op amp's inputs and outputs. To decrease stray capacitance, minimize trace lengths by placing external components close to the op amp's pins. Use surface-mount components for best results.

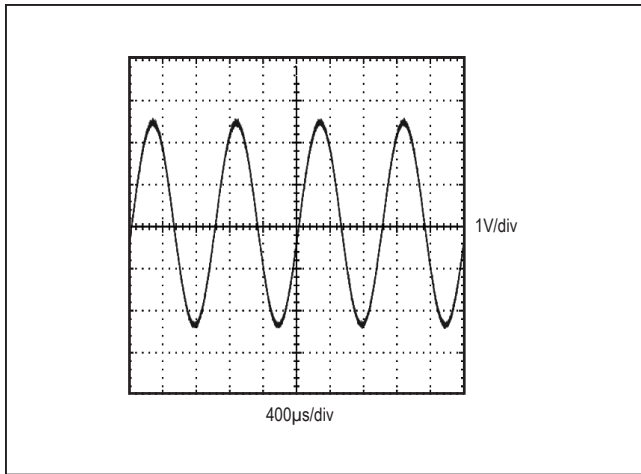

Figure 1. Rail-to-Rail Output Operation

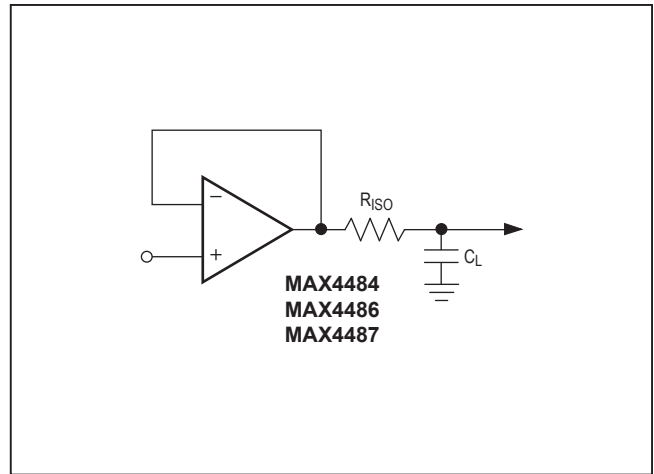

Figure 3. Capacitive-Load-Driving Circuit

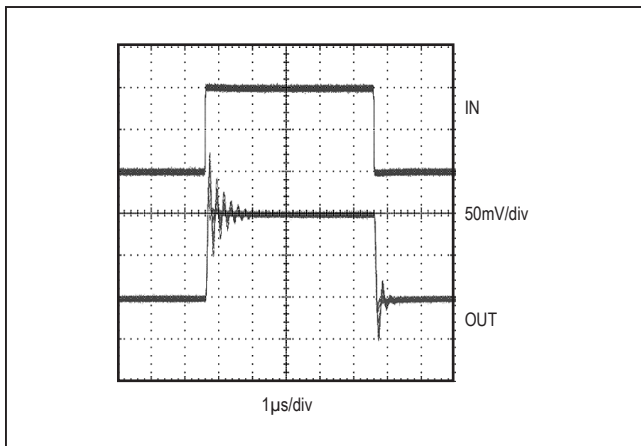

Figure 2. Small-Signal Transient Response with Excessive Capacitive Load ($C_L = 270\text{pF}$)

Package Information

For the latest package outline information and land patterns (footprints), go to www.maximintegrated.com/packages. Note that a "+", "#", or "-" in the package code indicates RoHS status only. Package drawings may show a different suffix character, but the drawing pertains to the package regardless of RoHS status.

| PACKAGE TYPE | PACKAGE CODE | DOCUMENT NO. | LAND PATTERN NO. |
|--------------|--------------|-------------------------|-------------------------|
| 5 SC70 | X5-1 | 21-0076 | 90-0188 |
| 5 SOT23 | U5-1 | 21-0057 | 90-0174 |
| 8 µMAX | U8-1 | 21-0036 | 90-0092 |
| 8 SO | S8-2 | 21-0041 | 90-0096 |
| 8 SOT23 | K8-5 | 21-0078 | 90-0176 |
| 14 TSSOP | U14-1 | 21-0066 | 90-0113 |
| 14 SO | S14-1 | 21-0041 | 90-0112 |

Revision History

| REVISION NUMBER | REVISION DATE | DESCRIPTION | PAGES CHANGED |
|-----------------|---------------|--------------------------------------------------------------------------|---------------|
| 0 | 10/00 | Initial release | — |
| 1 | 5/14 | Updated <i>General Description</i> | 1 |
| 2 | 12/20 | Updated <i>Ordering Information</i> and <i>Package Information</i> table | 1, 7 |

For pricing, delivery, and ordering information, please visit Maxim Integrated's online storefront at <https://www.maximintegrated.com/en/storefront/storefront.html>.

Maxim Integrated cannot assume responsibility for use of any circuitry other than circuitry entirely embodied in a Maxim Integrated product. No circuit patent licenses are implied. Maxim Integrated reserves the right to change the circuitry and specifications without notice at any time. The parametric values (min and max limits) shown in the Electrical Characteristics table are guaranteed. Other parametric values quoted in this data sheet are provided for guidance.

Looking for pricing, stock, or lifecycle information?

Click below to explore more details on WIN SOURCE:

- ⊖ [View MAX4486ASA on WIN SOURCE](#)
- ⊖ [Analog Devices Inc. Information](#)

Optimize Your Supply Chain with WIN SOURCE Solutions

- ✓ Global Sourcing Solution
- ✓ Obsolete Management
- ✓ Cost Control Management
- ✓ Shortage Management
- ✓ Alternative Solution
- ✓ Excess Inventory Management