



**THE DATASHEET OF
ADCLK905BCPZ-R2**



FEATURES

- 95 ps propagation delay**
- 7.5 GHz toggle rate**
- 60 ps typical output rise/fall**
- 60 fs random jitter (RJ)**
- On-chip terminations at both input pins**
- Extended industrial temperature range: -40°C to $+125^{\circ}\text{C}$**
- 2.5 V to 3.3 V power supply ($V_{CC} - V_{EE}$)**

APPLICATIONS

- Clock and data signal restoration and level shifting**
- Automated test equipment (ATE)**
- High speed instrumentation**
- High speed line receivers**
- Threshold detection**
- Converter clocking**

GENERAL DESCRIPTION

The ADCLK905 (one input, one output), ADCLK907 (dual one input, one output), and ADCLK925 (one input, two outputs) are ultrafast clock/data buffers fabricated on the Analog Devices, Inc., proprietary XFCB3 silicon germanium (SiGe) bipolar process.

The ADCLK905/ADCLK907/ADCLK925 feature full-swing emitter coupled logic (ECL) output drivers. For PECL (positive ECL) operation, bias V_{CC} to the positive supply and V_{EE} to ground. For NECL (negative ECL) operation, bias V_{CC} to ground and V_{EE} to the negative supply.

The buffers offer 95 ps propagation delay, 7.5 GHz toggle rate, 10 Gbps data rate, and 60 fs random jitter (RJ).

The inputs have center tapped, $100\ \Omega$, on-chip termination resistors. A V_{REF} pin is available for biasing ac-coupled inputs.

The ECL output stages are designed to directly drive 800 mV each side into $50\ \Omega$ terminated to $V_{CC} - 2\ \text{V}$ for a total differential output swing of 1.6 V.

The ADCLK905/ADCLK907/ADCLK925 are available in 16-lead LFCSP packages.

TYPICAL APPLICATION CIRCUITS

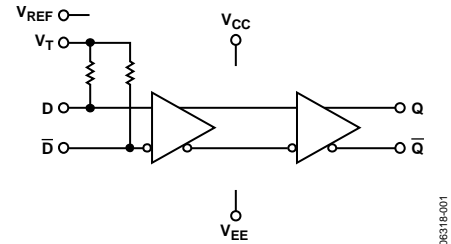

Figure 1. ADCLK905 ECL 1:1 Clock/Data Buffer

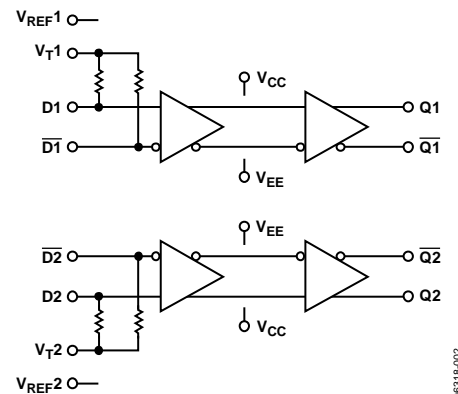

Figure 2. ADCLK907 ECL Dual 1:1 Clock/Data Buffer

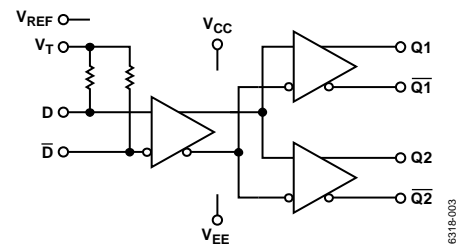

Figure 3. ADCLK925 ECL 1:2 Clock/Data Fanout Buffer

TABLE OF CONTENTS

Features	1	Typical Performance Characteristics	9
Applications.....	1	Applications Information	12
General Description	1	Power/Ground Layout and Bypassing	12
Typical Application Circuits.....	1	Output Stages	12
Revision History	2	Optimizing High Speed Performance	12
Specifications.....	3	Buffer Random Jitter	12
Electrical Characteristics	3	Typical Application Circuits	13
Absolute Maximum Ratings.....	5	Evaluation Board Schematic	14
Thermal Resistance	5	Outline Dimensions	15
ESD Caution.....	5	Ordering Guide	15
Pin Configurations and Function Descriptions	6		

REVISION HISTORY

2/2017—Rev. A to Rev. B

Changes to Figure 4 and Table 4.....	6
Changes to Figure 5 and Table 5.....	7
Changes to Figure 6 and Table 6.....	8

8/2016—Rev. 0 to Rev. A

Changed CP-16-3 to CP-16-27	Throughout
Changes to Figure 4 and Table 4.....	6
Changes to Figure 5 and Table 5.....	7
Changes to Figure 6 and Table 6.....	8
Updated Outline Dimensions	15
Changes to Ordering Guide	15

8/2007—Revision 0: Initial Version

SPECIFICATIONS

ELECTRICAL CHARACTERISTICS

Typical (Typ) values are given for $V_{CC} - V_{EE} = 3.3\text{ V}$ and $T_A = 25^\circ\text{C}$, unless otherwise noted. Minimum (Min) and maximum (Max) values are given over the full $V_{CC} - V_{EE} = 3.3\text{ V} \pm 10\%$ and $T_A = -40^\circ\text{C}$ to $+125^\circ\text{C}$ variation, unless otherwise noted.

Table 1.

Parameter	Symbol	Min	Typ	Max	Unit	Test Conditions/Comments
DC INPUT CHARACTERISTICS						
Input Voltage High Level	V_{IH}	$V_{EE} + 1.6$		V_{CC}	V	
Input Voltage Low Level	V_{IL}	V_{EE}		$V_{CC} - 0.7$	V	
Input Differential Range	V_{ID}	0.2		3.4	V p-p	-40°C to $+85^\circ\text{C}$ ($\pm 1.7\text{ V}$ between input pins)
	V_{ID}	0.2		2.8	V p-p	85°C to 125°C ($\pm 1.4\text{ V}$ between input pins)
Input Capacitance	C_{IN}		0.4		pF	
Input Resistance, Single-Ended Mode			50		Ω	
Input Resistance, Differential Mode			100		Ω	
Input Resistance, Common Mode			50		k Ω	Open V_T
Input Bias Current			20		μA	
DC OUTPUT CHARACTERISTICS						
Output Voltage High Level	V_{OH}	$V_{CC} - 1.26$		$V_{CC} - 0.76$	V	$50\ \Omega$ to $(V_{CC} - 2.0\text{ V})$
Output Voltage Low Level	V_{OL}	$V_{CC} - 1.99$		$V_{CC} - 1.54$	V	$50\ \Omega$ to $(V_{CC} - 2.0\text{ V})$
Output Voltage Differential	V_{OD}	610		1040	mV	$50\ \Omega$ to $(V_{CC} - 2.0\text{ V})$
Reference Voltage	V_{REF}					
Output Voltage			$(V_{CC} + 1)/2$		V	$-500\ \mu\text{A}$ to $+500\ \mu\text{A}$
Output Resistance			250		Ω	
AC PERFORMANCE						
Propagation Delay	t_{PD}	70	95	125	ps	$V_{CC} = 3.3\text{ V} \pm 10\%$, $V_{ICM} = V_{REF}$, $V_{ID} = 0.5\text{ V p-p}$
		70	95	125	ps	$V_{CC} = 2.5\text{ V} \pm 5\%$, $V_{ICM} = V_{REF}$, $V_{ID} = 0.5\text{ V p-p}$
Propagation Delay Temperature Coefficient			50		fs/ $^\circ\text{C}$	
Propagation Delay Skew (Output to Output) ADCLK907				15	ps	$V_{ID} = 0.5\text{ V}$
Propagation Delay Skew (Output to Output) ADCLK925				10	ps	$V_{ID} = 0.5\text{ V}$
Propagation Delay Skew (Device to Device) Toggle Rate		6	7.5	35	ps	$V_{ID} = 0.5\text{ V}$
			6.5		GHz	$>0.8\text{ V}$ differential output swing, $V_{CC} = 3.3\text{ V} \pm 10\%$
					GHz	$>0.8\text{ V}$ differential output swing, $V_{CC} = 2.5\text{ V} \pm 5\%$
Random Jitter	RJ		60		fs rms	$V_{ID} = 1600\text{ mV}$, 8 V/ns , $V_{ICM} = 1.85\text{ V}$
Rise/Fall Time	t_R/t_F	30		85	ps	20%/80%
Additive Phase Noise						
622.08 MHz			-138		dBc/Hz	@10 Hz offset
			-144		dBc/Hz	@100 Hz offset
			-152		dBc/Hz	@1 kHz offset
			-159		dBc/Hz	@10 kHz offset
			-161		dBc/Hz	@100 kHz offset
			-161		dBc/Hz	>1 MHz offset
122.88 MHz			-135		dBc/Hz	@10 Hz offset
			-145		dBc/Hz	@100 Hz offset
			-153		dBc/Hz	@1 kHz offset
			-160		dBc/Hz	@10 kHz offset
			-161		dBc/Hz	@100 kHz offset
			-161		dBc/Hz	>1 MHz offset

Parameter	Symbol	Min	Typ	Max	Unit	Test Conditions/Comments
POWER SUPPLY						
Supply Voltage Requirement	$V_{CC} - V_{EE}$	2.375		3.63	V	2.5 V – 5% to 3.3 V + 10%
Power Supply Current						Static
ADCLK905						
Negative Supply Current	I_{VEE}		24		mA	$V_{CC} - V_{EE} = 2.5\text{ V}$
			25	40	mA	$V_{CC} - V_{EE} = 3.3\text{ V} \pm 10\%$
Positive Supply Current	I_{VCC}		47		mA	$V_{CC} - V_{EE} = 2.5\text{ V}$
			48	63	mA	$V_{CC} - V_{EE} = 3.3\text{ V} \pm 10\%$
ADCLK907						
Negative Supply Current	I_{VEE}		48		mA	$V_{CC} - V_{EE} = 2.5\text{ V}$
			50	80	mA	$V_{CC} - V_{EE} = 3.3\text{ V} \pm 10\%$
Positive Supply Current	I_{VCC}		94		mA	$V_{CC} - V_{EE} = 2.5\text{ V}$
			96	126	mA	$V_{CC} - V_{EE} = 3.3\text{ V} \pm 10\%$
ADCLK925						
Negative Supply Current	I_{VEE}		29		mA	$V_{CC} - V_{EE} = 2.5\text{ V}$
			31	51	mA	$V_{CC} - V_{EE} = 3.3\text{ V} \pm 10\%$
Positive Supply Current	I_{VCC}		76		mA	$V_{CC} - V_{EE} = 2.5\text{ V}$
			77	97	mA	$V_{CC} - V_{EE} = 3.3\text{ V} \pm 10\%$
Power Supply Rejection ¹	PSR_{VCC}		3		ps/V	$V_{CC} - V_{EE} = 3.0\text{ V} \pm 20\%$
Output Swing Supply Rejection ²	PSR_{VCC}		26		dB	$V_{CC} - V_{EE} = 3.0\text{ V} \pm 20\%$

¹ Change in T_{PD} per change in V_{CC} .² Change in output swing per change in V_{CC} .

ABSOLUTE MAXIMUM RATINGS

Table 2.

Parameter	Rating
Supply Voltage $V_{CC} - V_{EE}$	6.0V
Input Voltage D (D1, D2), \overline{D} ($\overline{D1}$, $\overline{D2}$)	$V_{EE} - 0.5V$ to $V_{CC} + 0.5V$
D1, D2, $\overline{D1}$, $\overline{D2}$ to V_T Pin (CML or PECL Termination)	± 40 mA
D (D1, D2) to \overline{D} ($\overline{D1}$, $\overline{D2}$)	$\pm 1.8V$
Maximum Voltage on Output Pins	$V_{CC} + 0.5V$
Maximum Output Current	35 mA
Input Termination, V_T to D (D1, D2), \overline{D} ($\overline{D1}$, $\overline{D2}$)	$\pm 2V$
Voltage Reference, V_{REF}	$V_{CC} - V_{EE}$
Temperature	
Operating Temperature Range, Ambient	-40°C to $+125^\circ\text{C}$
Operating Temperature, Junction	150°C
Storage Temperature Range	-65°C to $+150^\circ\text{C}$

Stresses at or above those listed under Absolute Maximum Ratings may cause permanent damage to the product. This is a stress rating only; functional operation of the product at these or any other conditions above those indicated in the operational section of this specification is not implied. Operation beyond the maximum operating conditions for extended periods may affect product reliability.

THERMAL RESISTANCE

θ_{JA} is specified for the worst-case conditions, that is, a device soldered in a circuit board for surface-mount packages.

Table 3. Thermal Resistance

Package Type	θ_{JA}	Unit
16-Lead LFCSP	70	$^\circ\text{C}/\text{W}$

ESD CAUTION



ESD (electrostatic discharge) sensitive device. Charged devices and circuit boards can discharge without detection. Although this product features patented or proprietary protection circuitry, damage may occur on devices subjected to high energy ESD. Therefore, proper ESD precautions should be taken to avoid performance degradation or loss of functionality.

PIN CONFIGURATIONS AND FUNCTION DESCRIPTIONS

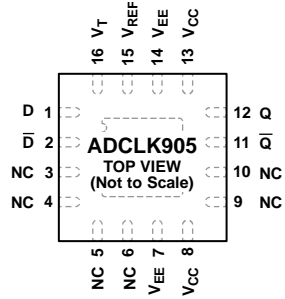

NOTES

1. NC = NO CONNECT. DO NOT CONNECT TO THIS PIN.
2. EXPOSED PAD. THE EXPOSED PAD IS NOT ELECTRICALLY CONNECTED TO ANY PART OF THE CIRCUIT. IT CAN BE LEFT FLOATING FOR OPTIMAL ELECTRICAL ISOLATION BETWEEN THE PACKAGE HANDLE AND THE SUBSTRATE OF THE DIE. IT CAN ALSO BE SOLDERED TO THE APPLICATION BOARD IF IMPROVED THERMAL AND/OR MECHANICAL STABILITY IS DESIRED. EXPOSED METAL AT THE CORNERS OF THE PACKAGE IS CONNECTED TO THIS EXPOSED PAD. ALLOW SUFFICIENT CLEARANCE TO VIAS AND OTHER COMPONENTS.

06318-004

Figure 4. ADCLK905 Pin Configuration

Table 4. Pin Function Descriptions for 1:1 ADCLK905 Buffer

Pin No.	Mnemonic	Description
1	D	Noninverting Input.
2	\overline{D}	Inverting Input.
3, 4, 5, 6, 9, 10	NC	No Connect. No physical connection to the die.
7, 14	V_{EE}	Negative Supply Voltage.
8, 13	V_{CC}	Positive Supply Voltage.
11	\overline{Q}	Inverting Output.
12	Q	Noninverting Output.
15	V_{REF}	Reference Voltage. Reference voltage for biasing ac-coupled inputs.
16	V_T	Center Tap. Center tap of 100 Ω input resistor.
	EPAD	Exposed Pad. The exposed pad is not electrically connected to any part of the circuit. It can be left floating for optimal electrical isolation between the package handle and the substrate of the die. It can also be soldered to the application board if improved thermal and/or mechanical stability is desired. Exposed metal at the corners of the package is connected to this exposed pad. Allow sufficient clearance to vias and other components.

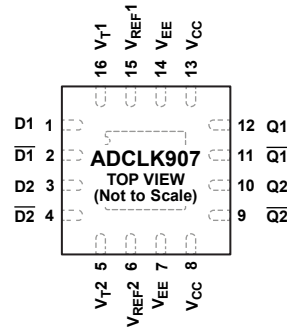

NOTES

1. EXPOSED PAD. THE EXPOSED PAD IS NOT ELECTRICALLY CONNECTED TO ANY PART OF THE CIRCUIT. IT CAN BE LEFT FLOATING FOR OPTIMAL ELECTRICAL ISOLATION BETWEEN THE PACKAGE HANDLE AND THE SUBSTRATE OF THE DIE. IT CAN ALSO BE SOLDERED TO THE APPLICATION BOARD IF IMPROVED THERMAL AND/OR MECHANICAL STABILITY IS DESIRED. EXPOSED METAL AT THE CORNERS OF THE PACKAGE IS CONNECTED TO THIS EXPOSED PAD. ALLOW SUFFICIENT CLEARANCE TO VIAS AND OTHER COMPONENTS.

063118-005

Figure 5. ADCLK907 Pin Configuration

Table 5. Pin Function Descriptions for Dual 1:1 ADCLK907 Buffer

Pin No.	Mnemonic	Description
1	D1	Noninverting Input 1.
2	$\overline{D1}$	Inverting Input 1.
3	D2	Noninverting Input 2.
4	$\overline{D2}$	Inverting Input 2.
5	V _{T2}	Center Tap 2. Center tap of 100 Ω input resistor, Channel 2.
6	V _{REF2}	Reference Voltage 2. Reference voltage for biasing ac-coupled inputs, Channel 2.
7, 14	V _{EE}	Negative Supply Voltage.
8, 13	V _{CC}	Positive Supply Voltage. Pin 8 and Pin 13 are not strapped internally.
9	$\overline{Q2}$	Inverting Output 2.
10	Q2	Noninverting Output 2.
11	$\overline{Q1}$	Inverting Output 1.
12	Q1	Noninverting Output 1.
15	V _{REF1}	Reference Voltage 1. Reference voltage for biasing ac-coupled inputs, Channel 1.
16	V _{T1}	Center Tap 1. Center tap of 100 Ω input resistor, Channel 1.
	EPAD	Exposed Pad. The exposed pad is not electrically connected to any part of the circuit. It can be left floating for optimal electrical isolation between the package handle and the substrate of the die. It can also be soldered to the application board if improved thermal and/or mechanical stability is desired. Exposed metal at the corners of the package is connected to this exposed pad. Allow sufficient clearance to vias and other components.

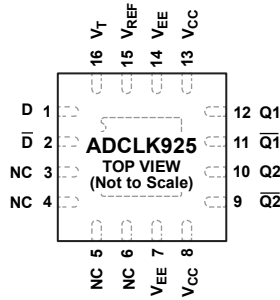

NOTES

1. NC = NO CONNECT. DO NOT CONNECT TO THIS PIN.
2. EXPOSED PAD. THE EXPOSED PAD IS NOT ELECTRICALLY CONNECTED TO ANY PART OF THE CIRCUIT. IT CAN BE LEFT FLOATING FOR OPTIMAL ELECTRICAL ISOLATION BETWEEN THE PACKAGE HANDLE AND THE SUBSTRATE OF THE DIE. IT CAN ALSO BE SOLDERED TO THE APPLICATION BOARD IF IMPROVED THERMAL AND/OR MECHANICAL STABILITY IS DESIRED. EXPOSED METAL AT THE CORNERS OF THE PACKAGE IS CONNECTED TO THIS EXPOSED PAD. ALLOW SUFFICIENT CLEARANCE TO VIAS AND OTHER COMPONENTS.

06318-006

Figure 6. ADCLK925 Pin Configuration

Table 6. Pin Function Descriptions for 1:2 ADCLK925 Buffer

Pin No.	Mnemonic	Description
1	D	Noninverting Input.
2	\overline{D}	Inverting Input.
3, 4, 5, 6	NC	No Connect. No physical connection to the die.
7, 14	V_{EE}	Negative Supply Voltage.
8, 13	V_{CC}	Positive Supply Voltage.
9	$\overline{Q2}$	Inverting Output 2.
10	$Q2$	Noninverting Output 2.
11	$\overline{Q1}$	Inverting Output 1.
12	$Q1$	Noninverting Output 1.
15	V_{REF}	Reference Voltage. Reference voltage for biasing ac-coupled inputs.
16	V_T	Center Tap. Center tap of 100 Ω input resistor.
	EPAD	Exposed Pad. The exposed pad is not electrically connected to any part of the circuit. It can be left floating for optimal electrical isolation between the package handle and the substrate of the die. It can also be soldered to the application board if improved thermal and/or mechanical stability is desired. Exposed metal at the corners of the package is connected to this exposed pad. Allow sufficient clearance to vias and other components.

TYPICAL PERFORMANCE CHARACTERISTICS

$V_{CC} = 3.3\text{ V}$, $V_{EE} = 0.0\text{ V}$, $T_A = 25^\circ\text{C}$, outputs terminated $50\ \Omega$ to $V_{CC} - 2\text{ V}$, unless otherwise noted.

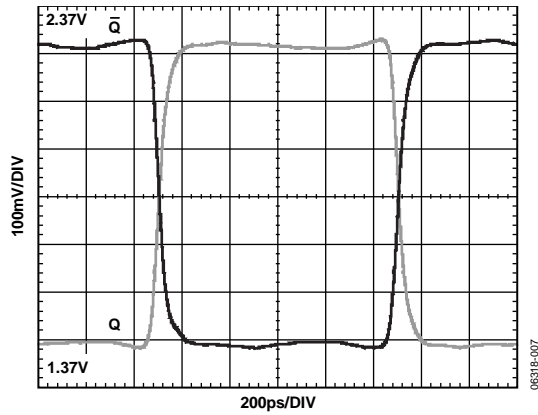

Figure 7. Output Waveform, $V_{CC} = 3.3\text{ V}$

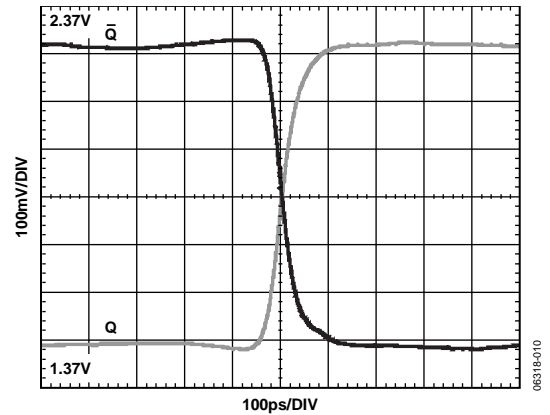

Figure 10. Output Waveform, $V_{CC} = 3.3\text{ V}$

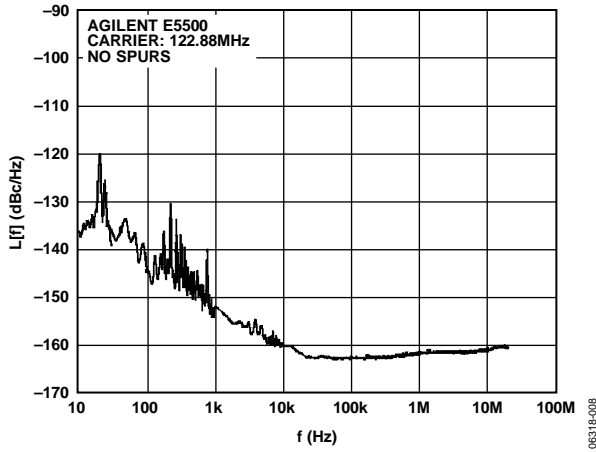

Figure 8. Phase Noise at 122.88 MHz

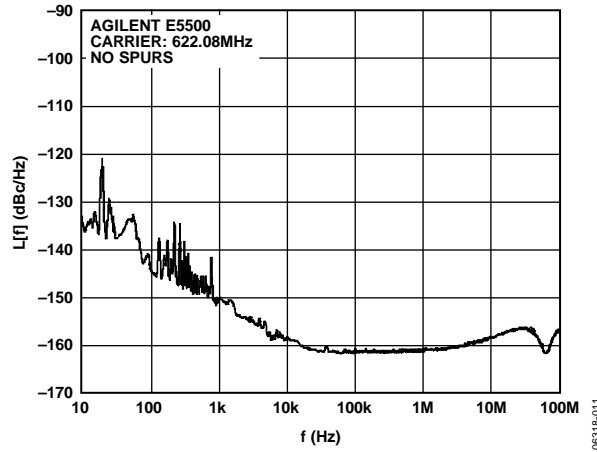

Figure 11. Phase Noise at 622.08 MHz

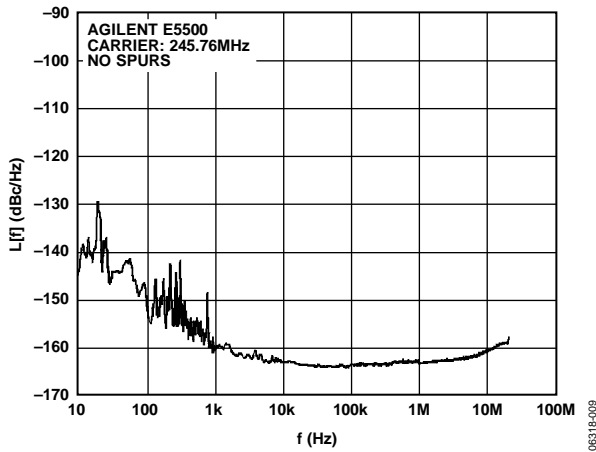

Figure 9. Phase Noise at 245.76 MHz

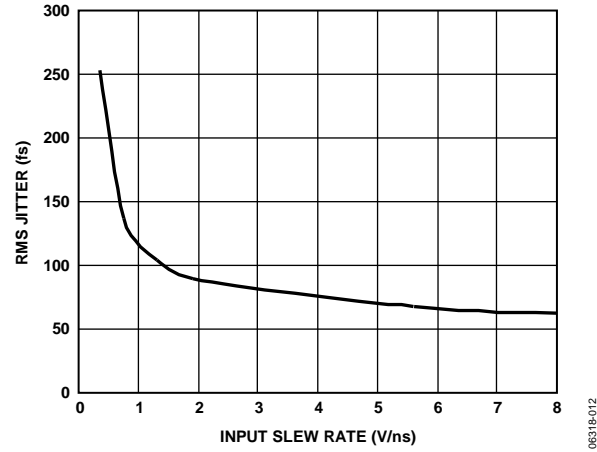

Figure 12. RMS Jitter vs. Input Slew Rate

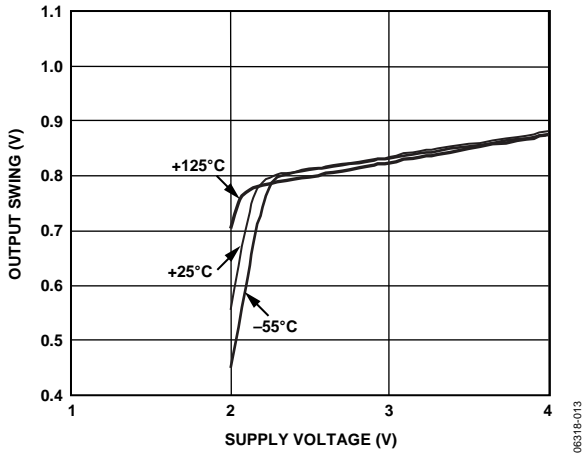

Figure 13. V_{OD} vs. Power Supply Voltage

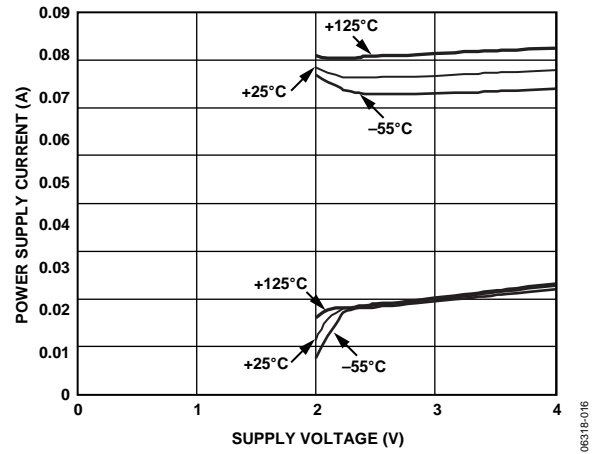

Figure 16. Power Supply Current vs. Supply Voltage, ADCLK925

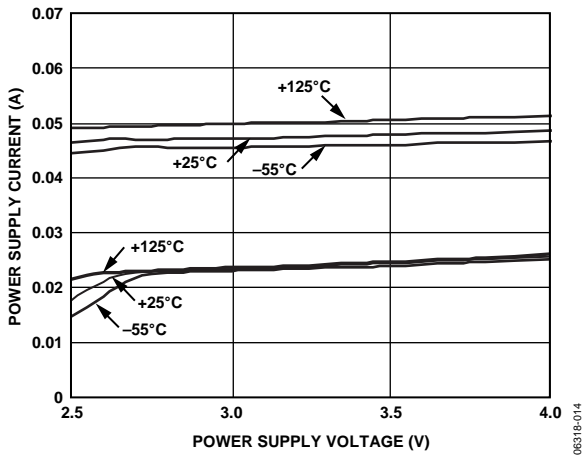

Figure 14. Power Supply Current vs. Power Supply Voltage, ADCLK905

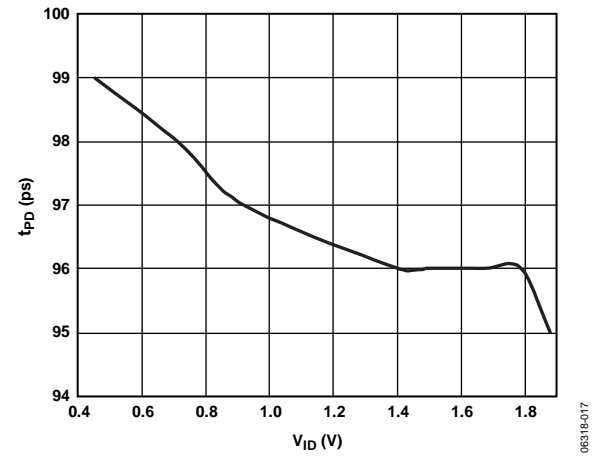

Figure 17. Propagation Delay vs. V_{ID}

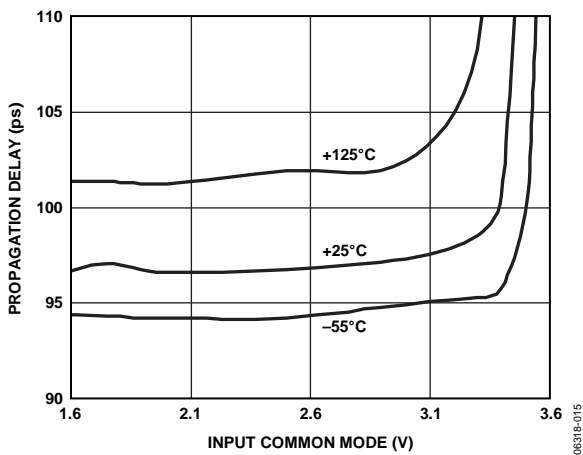

Figure 15. Propagation Delay vs. V_{ICM} ; Input Swing = 200 mV

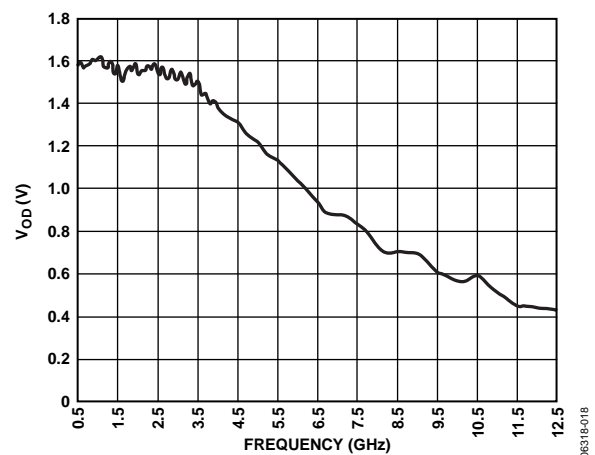

Figure 18. Toggle Rate, Differential Output Swing vs. Frequency

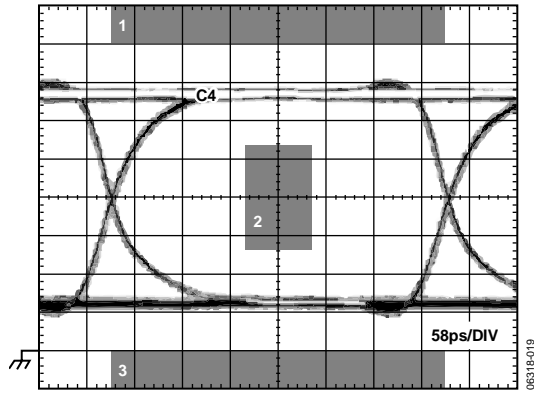

Figure 19. 2.488 Gbps PRBS $2^{23} - 1$ with OC-48/STM-16 Mask, Measured p-p Jitter 8.1 ps, Source p-p Jitter 3.5 ps

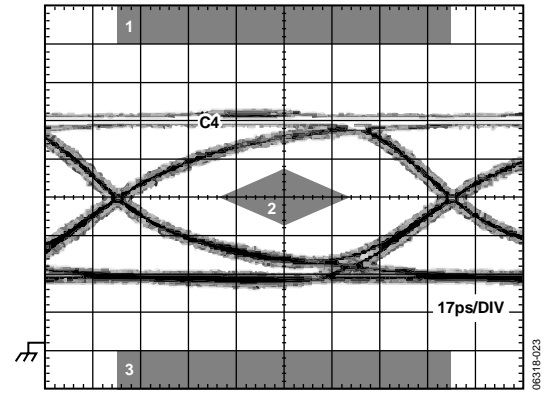

Figure 22. 8.50 Gbps PRBS $2^{23} - 1$ with FC8500E ABS Beta Rx Mask, Measured p-p Jitter 10.9 ps, Source p-p Jitter 4.4 ps

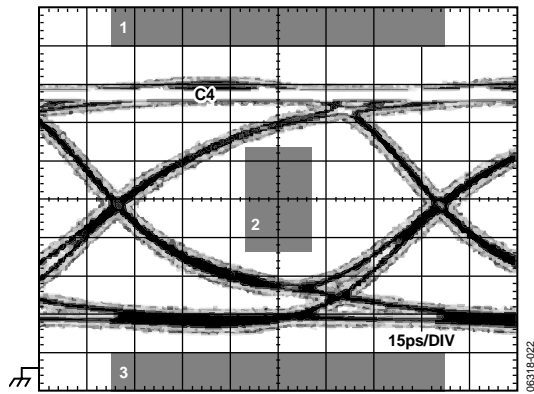

Figure 20. 9.95 Gbps PRBS $2^{23} - 1$ with OC-193/STM-64 Mask, Measured p-p Jitter 10.5 ps, Source p-p Jitter 6.0 ps

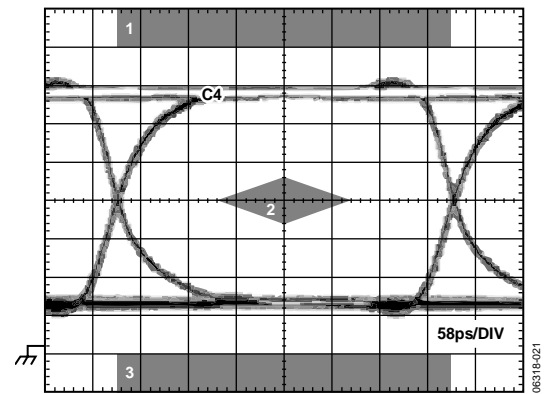

Figure 23. 2.5 Gbps PRBS $2^{23} - 1$ with PCI Express 2.5 Rx Mask, Measured p-p Jitter 8.1 ps, Source p-p Jitter 3.5 ps

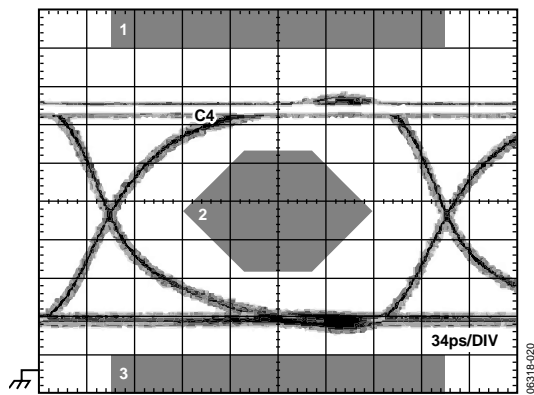

Figure 21. 4.25 Gbps PRBS $2^{23} - 1$ with FC4250 (Optical) Mask, Measured p-p Jitter 8.2 ps, Source p-p Jitter 3.4 ps

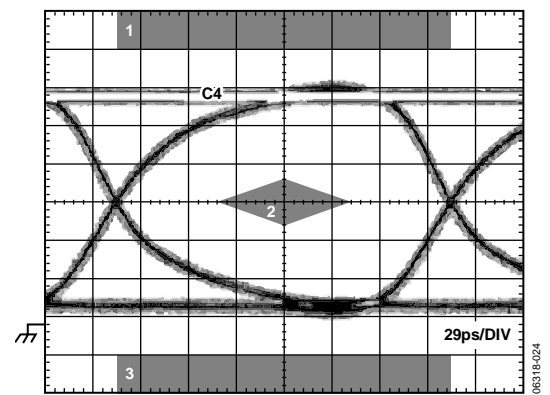

Figure 24. 5.0 Gbps PRBS $2^{23} - 1$ with PCI Express 5.0 Rx Mask, Measured p-p Jitter 8.7 ps, Source p-p Jitter 3.5 ps

APPLICATIONS INFORMATION

POWER/GROUND LAYOUT AND BYPASSING

The ADCLK905/ADCLK907/ADCLK925 buffers are designed for very high speed applications. Consequently, high speed design techniques must be used to achieve the specified performance. It is critically important to use low impedance supply planes for both the negative supply (V_{EE}) and the positive supply (V_{CC}) planes as part of a multilayer board. Providing the lowest inductance return path for switching currents ensures the best possible performance in the target application.

It is also important to adequately bypass the input and output supplies. A 1 μF electrolytic bypass capacitor should be placed within several inches of each power supply pin to ground. In addition, multiple high quality 0.001 μF bypass capacitors should be placed as close as possible to each of the V_{EE} and V_{CC} supply pins and should be connected to the GND plane with redundant vias. High frequency bypass capacitors should be carefully selected for minimum inductance and ESR. Parasitic layout inductance should be strictly avoided to maximize the effectiveness of the bypass at high frequencies.

OUTPUT STAGES

The specified performance can be achieved only by using proper transmission line terminations. The outputs of the ADCLK905/ADCLK907/ADCLK925 buffers are designed to directly drive 800 mV into 50 Ω cable or microstrip/stripline transmission lines terminated with 50 Ω referenced to $V_{CC} - 2\text{ V}$. The PECL output stage is shown in Figure 25. The outputs are designed for best transmission line matching. If high speed signals must be routed more than a centimeter, either the microstrip or the stripline technique is required to ensure proper transition times and to prevent excessive output ringing and pulse width-dependent propagation delay dispersion.

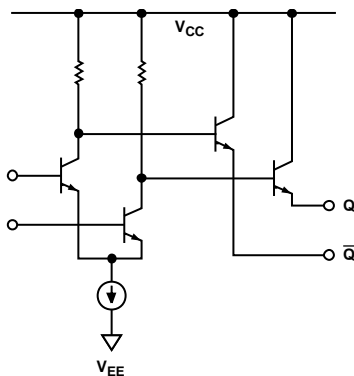

Figure 25. Simplified Schematic Diagram of the ADCLK905/ADCLK907/ADCLK925 PECL Output Stage

OPTIMIZING HIGH SPEED PERFORMANCE

As with any high speed circuit, proper design and layout techniques are essential to obtaining the specified performance. Stray capacitance, inductance, inductive power and ground impedances, or other layout issues can severely limit performance and cause oscillation. Discontinuities along input and output transmission lines can also severely limit the specified jitter performance by reducing the effective input slew rate.

In a 50 Ω environment, input and output matching have a significant impact on performance. The buffer provides internal 50 Ω termination resistors for both D and \bar{D} inputs. The return side should normally be connected to the reference pin provided. The termination potential should be carefully bypassed, using ceramic capacitors to prevent undesired aberrations on the input signal due to parasitic inductance in the termination return path. If the inputs are directly coupled to a source, care must be taken to ensure the pins are within the rated input differential and common-mode ranges.

If the return is floated, the device exhibits 100 Ω cross termination, but the source must then control the common-mode voltage and supply the input bias currents.

There are ESD/clamp diodes between the input pins to prevent the application of excessive offsets to the input transistors. ESD diodes are not optimized for best ac performance. When a clamp is desired, it is recommended that appropriate external diodes be used.

BUFFER RANDOM JITTER

The ADCLK905/ADCLK907/ADCLK925 are specifically designed to minimize added random jitter over a wide input slew rate range. Provided sufficient voltage swing is present, random jitter is affected most by the slew rate of the input signal. Whenever possible, excessively large input signals should be clamped with fast Schottky diodes because attenuators reduce the slew rate. Input signal runs of more than a few centimeters should be over low loss dielectrics or cables with good high frequency characteristics.

TYPICAL APPLICATION CIRCUITS

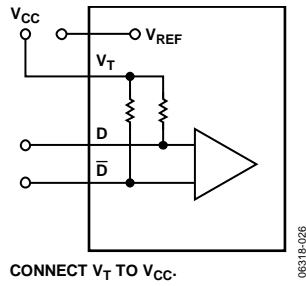

CONNECT V_T TO V_{CC} .

06318-026

Figure 26. Interfacing to CML Inputs

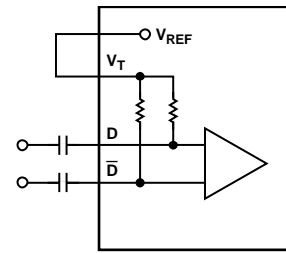

CONNECT V_T TO V_{REF} .

NOTES
1. PLACING A BYPASS CAPACITOR FROM V_T TO GROUND CAN IMPROVE THE NOISE PERFORMANCE.

06318-029

Figure 28. AC Coupling Differential Signals

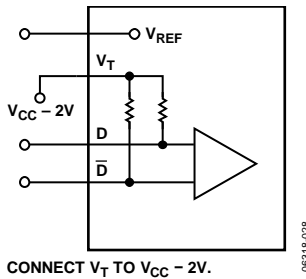

CONNECT V_T TO $V_{CC} - 2V$.

06318-028

Figure 27. Interfacing to PECL

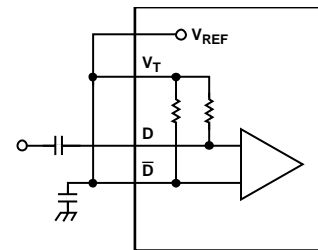

CONNECT V_T , V_{REF} , AND \bar{D} . PLACE A BYPASS CAPACITOR FROM V_T TO GROUND. ALTERNATIVELY, V_T , V_{REF} , AND D CAN BE CONNECTED, GIVING A CLEANER LAYOUT AND A 180° PHASE SHIFT.

06318-030

Figure 29. Interfacing to AC-Coupled Single-Ended Inputs

EVALUATION BOARD SCHEMATIC

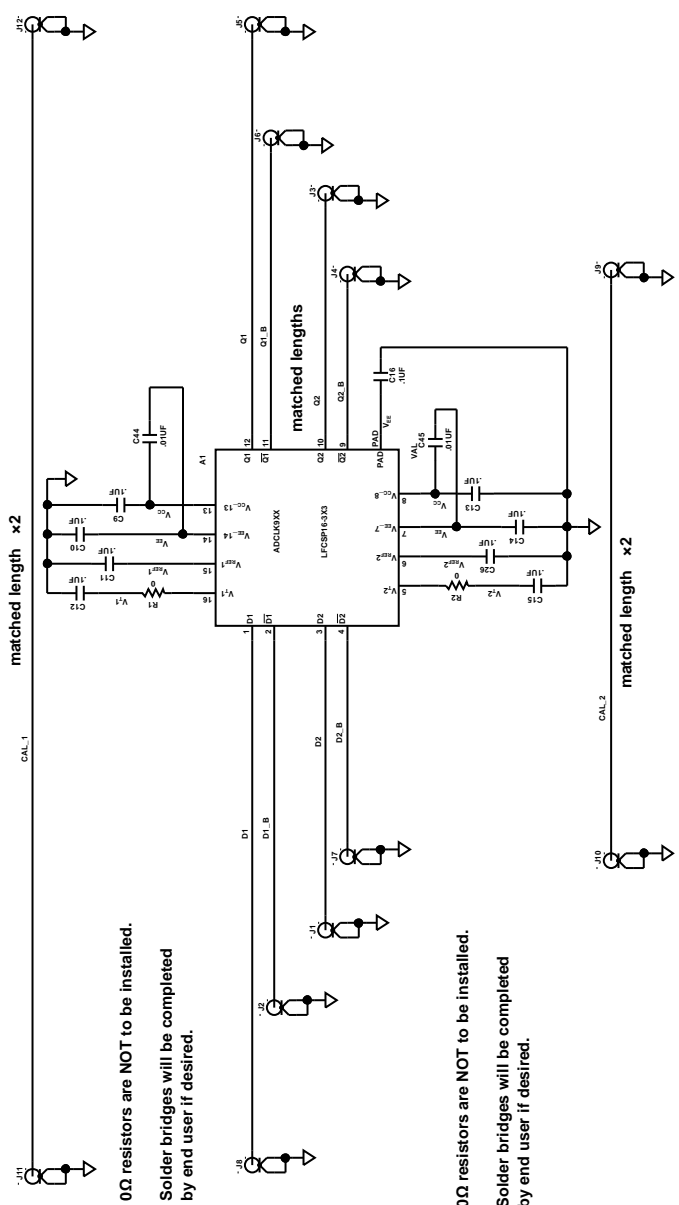
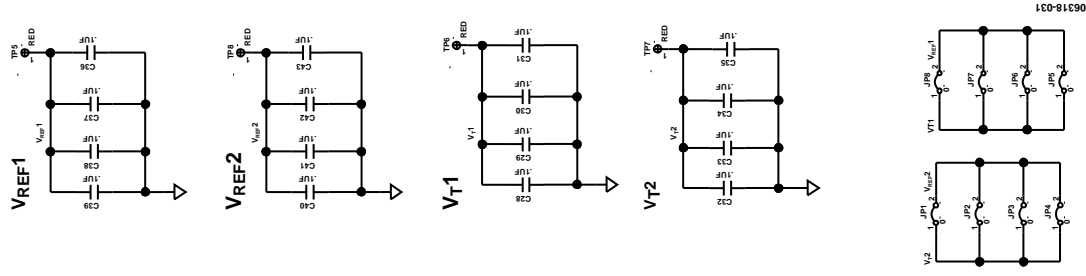

0Ω resistors are NOT to be installed.
Solder bridges will be completed by end user if desired.

0Ω resistors are NOT to be installed.
Solder bridges will be completed by end user if desired.

Jumpers are NOT to be installed.
Solder bridges will be completed by end user if desired.

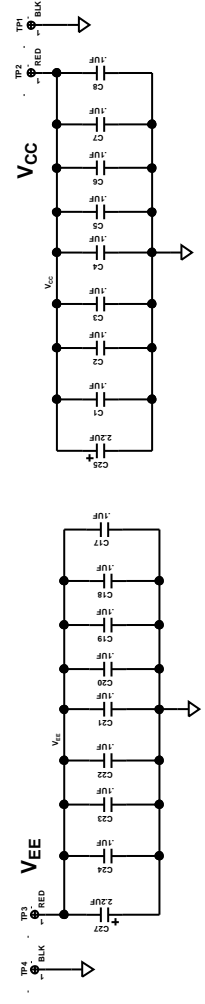

Figure 30. Evaluation Board Schematic

NOTES

Looking for pricing, stock, or lifecycle information?

Click below to explore more details on WIN SOURCE:

 [View ADCLK905BCPZ-R2 on WIN SOURCE](#)

 [Analog Devices Inc. Information](#)

Optimize Your Supply Chain with WIN SOURCE Solutions

-  Global Sourcing Solution
-  Obsolete Management
-  Cost Control Management
-  Shortage Management
-  Alternative Solution
-  Excess Inventory Management