



**THE DATASHEET OF
MAX15068ATP+**



Click [here](#) for production status of specific part numbers.

MAX15068

Dual ORing, Single Hot-Swap Controller with Accurate Current Monitoring

General Description

The MAX15068 offers ORing function and hot-swap features for two input-supply-rail applications requiring the safe insertion and removal of circuit line cards from a live backplane. The device integrates dual ORing MOSFET controllers, a single hot-swap controller, electronic circuit-breaker protection, and power monitoring in a single package. The device operates on 2.9V to 18V supply voltages.

The device regulates the forward voltage drop across the ORing MOSFETs to ensure smooth current transfer from one supply to the other without oscillation. The ORing MOSFET turns on quickly to reduce the load voltage drop during supply switchover. If the input supply fails or is shorted, a fast turn-off minimizes reverse-current transients.

The device implements a foldback current limit during hot-swap startup in order to control inrush current, thereby keeping the hot-swap MOSFET under safe operating area (SOA). After the hot-swap startup cycle is completed, on-chip comparators provide active current-limit protection against short-circuit and overcurrent faults. The load is disconnected from the input quickly in the event of a fault condition.

The device provides a current-sense amplifier output. A voltage proportional to the current delivered to the system can be read directly at the IPMON pin.

The device is factory-calibrated to deliver accurate overcurrent protection with $\pm 5\%$ accuracy. During an overcurrent-fault condition, the device enters an autoretry mode. The device features an adjustable slew-rate control during startup. Additional features include power-good and fault-indicator outputs.

The MAX15068 is available in a 20-pin, (4mm x 5mm) TQFN package and is specified from a -40°C to $+125^{\circ}\text{C}$ operating temperature range.

Benefits and Features

- 2.9V to 18V Operating Voltage Range (ORing and Hot Swap)
- Seamless Power Transition of Redundant Supplies
- Controls n-Channel MOSFETs
- $< 0.5\mu\text{s}$ Reverse Turn-Off Time
- Precision Current Monitoring
- Adjustable Slew-Rate Control
- Adjustable Current-Limit Fault Delay
- Adjustable Circuit-Breaker Current Threshold
- Inrush Current Regulated at Startup
- Adjustable Undervoltage Lockout
- Small (4mm x 5mm) TQFN Package

Applications

- Baseband Station
- Redundant Power Supplies
- Supply Holdup
- Computer Systems and Servers
- Telecom Networks
- Storage Bridge Bay

Ordering Information appears at end of data sheet.

Absolute Maximum Ratings

IN1, IN2 to GND	-1V to +24V	CP2 to IN2	-0.3V to +14V
PG, EN, FAULT, CSN to GND	-0.3V to +24V	OG1	(VIN1 - 0.3V) to (VCP1 + 0.3V)
CSP to GND	Max (-0.3V, VIN_ - 0.6V) to +24V	OG2	(VIN2 - 0.3V) to (VCP2 + 0.3V)
VS to GND	-0.3V to +6V	Current into EN, PG, FAULT	20mA
ON, PC, IPMON, CB, CDLY to GND	-0.3V to (VS + 0.3V)	Continuous Power Dissipation (TA = +70°C)	
CSP to CSN	-0.3V to +0.3V	20-Pin TQFN (derate 30mW/°C above +70°C)	2400mW
OUT to GND	-0.3V to +24V	Operating Temperature Range	-40°C to +125°C
GATE to GND	-0.3V to +36V	Junction Temperature	+150°C
GATE to OUT	-0.3V to +20V	Storage Temperature Range	-65°C to +150°C
CP1 to GND	-0.3V to +36V	Lead Temperature (soldering, 10s)	+300°C
CP1 to IN1	-0.3V to +14V	Soldering Temperature (reflow)	+260°C
CP2 to GND	-0.3V to +36V		

Stresses beyond those listed under "Absolute Maximum Ratings" may cause permanent damage to the device. These are stress ratings only, and functional operation of the device at these or any other conditions beyond those indicated in the operational sections of the specifications is not implied. Exposure to absolute maximum rating conditions for extended periods may affect device reliability.

Package Information

PACKAGE TYPE: 20-PIN TQFN	
Package Code	T2045+1C
Outline Number	21-0726
Land Pattern Number	90-100091
THERMAL RESISTANCE, FOUR-LAYER BOARD	
Junction to Ambient (θJA)	33.5°C/W

For the latest package outline information and land patterns (footprints), go to www.maximintegrated.com/packages. Note that a "+", "#", or "-" in the package code indicates RoHS status only. Package drawings may show a different suffix character, but the drawing pertains to the package regardless of RoHS status.

Package thermal resistances were obtained using the method described in JEDEC specification JESD51-7, using a four-layer board. For detailed information on package thermal considerations, refer to www.maximintegrated.com/thermal-tutorial.

Electrical Characteristics

(VIN1 = VIN2 = 12V, CIN1 = CIN2 = CVS = 1µF, TA = -40°C to +125°C. Typical values are at TA = +25°C, unless otherwise noted.) (Note 1)

PARAMETER	SYMBOL	CONDITIONS	MIN	TYP	MAX	UNITS
SUPPLY VOLTAGE						
Input Supply Voltage	VIN	Hot swap and ORing	2.9		18	V
		Current monitor	4.8		18	
Input Supply Current	IIN			4		mA
Internal LDO Output Voltage	VS		4.8	5	5.25	V
VS Undervoltage Lockout	VUVLO	VS rising	2.5	2.65	2.8	V
VS Undervoltage-Lockout Hysteresis	VUVLO_HYS			0.07		V
CSP Undervoltage Lockout	VCSP_UVLO	VCSP rising	2.4	2.49	2.58	V
		VCSP falling	2.25	2.35	2.42	

Electrical Characteristics (continued)

(V_{IN1} = V_{IN2} = 12V, C_{IN1} = C_{IN2} = C_{VS} = 1μF, T_A = -40°C to +125°C. Typical values are at T_A = +25°C, unless otherwise noted.) (Note 1)

PARAMETER	SYMBOL	CONDITIONS	MIN	TYP	MAX	UNITS	
ORING							
ORing MOSFET Forward Regulation Voltage (V _{IN_} - V _{CS})	V _{FWD_REG}		7.5	10	12.5	mV	
ORing MOSFET Reverse Bias Turn-Off Voltage	V _{REV_OFF}	V _{IN_} - V _{CS} , V _{CS} rising (V _{CS} > V _{IN_}), V _{OG_} goes low	-25	-20	-15	mV	
ORing MOSFET Reverse Bias Turn-On Voltage	V _{REV_ON}	V _{IN_} - V _{CS} , V _{CS} falling, (V _{IN_} > V _{CS_}), V _{OG_} goes to forward regulation	-20	-15	-10	mV	
ORing MOSFET Reverse Bias Hysteresis Voltage	V _{REV_HYS}	V _{REV_OFF} - V _{REV_ON}		5		mV	
Turn-Off Switch Resistance	R _{DS_OFF}	V _{IN_} - V _{CS} = -50mV, I = 50mA		0.8		Ω	
Turn-On Switch Resistance	R _{DS_ON}	V _{IN_} - V _{CS_} = 120mV, I = 70mA		2		Ω	
ORing MOSFET Gate Drive (V _{OG_} - V _{IN_})	V _{OG_}	2.9V < V _{IN_} < 18V	5.2	11	12	V	
ORing MOSFET Fast Turn-On Threshold	V _{FWD_ON}	V _{IN_} - V _{CS} rising		80		mV	
ORing MOSFET Fast Turn-Off	V _{FWD_OFF}	V _{IN_} - V _{CS} falling, V _{OG_} goes to forward regulation		40		mV	
ORing MOSFET Turn-On Delay	t _{ON_OG_}	C _{GATE} = 10nF, V _{IN_} - V _{CS} = +0.05V		20		μs	
ORing MOSFET Turn-Off Delay	t _{OFF_OG_}	C _{GATE} = 10nF, V _{IN_} - V _{CS} = -0.05V, V _{OG_} = 0.1 x (V _{CP_} - V _{IN_})		300	500	ns	
PC to OG2 Delay	t _{LH_DLY}	V _{PC} falling edge to V _{OG2} going high		40	65	μs	
HOT SWAP							
Circuit-Breaker Accuracy	V _{CB_TH}	V _{CS} - V _{CSN}	V _{CB} = 0V	32.9	35	37.1	mV
			V _{CB} = open	47.5	50	52.5	
			V _{CB} = V _S	61.1	65	68.9	
Active Current-Limit Sense Voltage	V _{ACL}			1.3 x V _{CB_TH}		mV	
Fast Comparator Threshold	V _{FC_TH}	V _{CS} - V _{CSN}		3 x V _{CB_TH}		mV	
Fast Comparator Response Time	t _{FC_DLY}	V _{CS} - V _{CSN} = 300mV, C _{GATE} = 10nF (Note 3)		160		ns	
GATE Off Delay	t _{OFF_GATE}	V _{EN} high to V _{GATE} low		20	40	μs	
		V _{ON} low to V _{GATE} low		10	20		
GATE Propagation Delay	t _{ON_GATE_PD}	V _{ON} = step 0.8V to 2V		10	20	μs	
GATE Drive Voltage (V _{GATE} - V _{OUT})	V _{GATE}	2.9V < V _{IN_} < 18V	6	11		V	
GATE Pullup Current	I _{GATE_ON}	V _{GATE} - V _{OUT} = 0V	-13	-10	-7	μA	

Electrical Characteristics (continued)(V_{IN1} = V_{IN2} = 12V, C_{IN1} = C_{IN2} = C_{VS} = 1μF, T_A = -40°C to +125°C. Typical values are at T_A = +25°C, unless otherwise noted.) (Note 1)

PARAMETER	SYMBOL	CONDITIONS	MIN	TYP	MAX	UNITS
GATE Pulldown Current (Timeout)	I _{GATE_OFF}	V _{OUT} = 12V, V _{GATE} = V _{OUT} + 5V	350	500	650	μA
GATE Fast Pulldown Current	I _{GATE_FAST_OFF}	V _{OUT} = 12V, V _{GATE} = V _{OUT} + 5V	75	200	260	mA
HOT-SWAP FOLDBACK						
Minimum CB Voltage	V _{CB_FBMAX}	(V _{CSP} - V _{CSN}) = 12V	3	6.7	10.7	% V _{CB_TH}
Minimum Foldback Voltage	V _{FBMIN}	V _{CSP} - V _{OUT} , at V _{CB} = V _{CB_FBMAX}	1	2.1	3.2	V
Maximum Foldback Voltage	V _{FBMAX}	V _{CSP} - V _{OUT} , at V _{CB} = V _{CB_TH}	9	10	11	V
CURRENT-SENSING INPUT						
CSP Input Current	I _{CSP}	V _{CSP} = 12V		0.5	1.0	mA
CSN Input Current	I _{CSN}	V _{CSN} = 12V	100	200	400	μA
CDLY						
CDLY Upper Threshold	V _{CDLY_U}	V _{CDLY} rising	1.1	1.2	1.3	V
CDLY Lower Threshold Hysteresis	V _{CDLY_L}	V _{CDLY} falling		0.2		V
CDLY Pullup Current	I _{CDLY_UP}		-135	-100	-65	μA
CDLY Pulldown Current	I _{CDLY_DOWN}		1.1	2	2.8	μA
CDLY Ratio	I _{CDLY_DOWN} / I _{CDLY_UP}		1.2	2	3.2	%
POWER-GOOD (PG)						
PG Threshold OUT	V _{PG_OUT}	V _{GATE} > (5V + V _{OUT})		0.9 x V _{CSP}		V
PG Threshold GATE	V _{PG_GATE}	V _{GATE} - V _{OUT}		4.2		V
PG Detection Timeout	t _{PG_STARTUP}		55	70	85	ms
PG Assertion Delay	t _{PG_DELAY}		13	16	19	ms
OUTPUTS (FAULT, PG)						
FAULT, PG Output Voltage Low	V _{OL}	I _{PG} = I _{FAULT} = 1mA			0.4	V
FAULT, PG Output Voltage High	V _{OH}	I _{PG} = I _{FAULT} = 1μA	V _S - 1	V _S - 0.6		V
FAULT, PG Leakage Current	I _{OH}	V _{PG} = V _{FAULT} = 18V	-1		+20	μA
FAULT, PG Pullup Current	I _{PU}	V _{PG} = V _{FAULT} = 1.5V	-13	-10	-7	μA

Electrical Characteristics (continued)(V_{IN1} = V_{IN2} = 12V, C_{IN1} = C_{IN2} = C_{VS} = 1μF, T_A = -40°C to +125°C. Typical values are at T_A = +25°C, unless otherwise noted.) (Note 1)

PARAMETER	SYMBOL	CONDITIONS	MIN	TYP	MAX	UNITS	
INPUTS							
ON, PC, $\overline{\text{EN}}$ Turn-On Threshold	V _{ON_TH}	V _{ON} , V _{PC} , V $\overline{\text{EN}}$ rising	1.1	1.22	1.32	V	
ON, PC, $\overline{\text{EN}}$ Turn-On Threshold Hysteresis	V _{ON_HYS}	V _{ON} , V _{PC} , V $\overline{\text{EN}}$ falling hysteresis	70	123	180	mV	
ON Fault Reset Threshold Voltage	V _{ON_RESET}	V _{ON} falling	0.5	0.6	0.7	V	
ON, PC Input Leakage Current	I _{LEAK}	V _{ON} , V _{PC} = 0 to 2.5V	-1		+1	μA	
ON, PC Clamp Voltage		I _{SINK} = 1μA		3		V	
ON, PC Clamp Sink		V _{ON} , V _{PC} = 5V		300		μA	
$\overline{\text{EN}}$ Pullup Current	I _{PU}	V $\overline{\text{EN}}$ = 0V	-13	-10	-7	μA	
CB THREE-STATE INPUT							
CB Input Low Current	I _{IN_LOW}	V _{CB} = 0.4V	-75			μA	
CB Input High Current	I _{IN_HIGH}	V _{CB} = V _S - 0.2V			+75	μA	
CB Input Open-Current Voltage	V _{CB_OPEN}	Force ±4μA into unconnected CB pin; then measure voltage on the CB pin	1.0		V _S - 1	V	
CB Low Voltage	V _{IL}	V _{CB} rising	0.4			V	
CB High Voltage	V _{IH}	V _{CB} falling, relative to V _S			V _S - 0.2		
CURRENT MONITORING							
Current Monitor vs. Undervoltage Lockout	V _{IPMON_UVLO}	V _S rising Hysteresis	4.1	4.16	4.23	V	
IPMON Offset (Note 2)	V _{IPMON_O}	V _{CSP} = 12V	T _A = +25°C	-80	+80	μV	
			T _A = 0°C to +85°C	-200	+200		
		T _A = -40°C to +125°C	-240	+240			
IPMON Gain (Note 2)	G _{IM}	V _{CSP} = 12V	T _A = +25°C	71.315	71.565	71.815	V/V
			T _A = 0°C to +85°C	71.136	71.565	71.994	
		T _A = -40°C to +125°C	70.992	71.565	72.138		
		V _{CSP} = 4.8V to 18V	T _A = -40°C to +125°C	70.992	71.565	72.138	

Electrical Characteristics (continued)

($V_{IN1} = V_{IN2} = 12V$, $C_{IN1} = C_{IN2} = C_{VS} = 1\mu F$, $T_A = -40^{\circ}C$ to $+125^{\circ}C$. Typical values are at $T_A = +25^{\circ}C$, unless otherwise noted.) (Note 1)

PARAMETER	SYMBOL	CONDITIONS	MIN	TYP	MAX	UNITS
Current Monitoring Total Accuracy (Note 3)	VIPMON_ACCURACY	$V_{CSP} = 12V$, $R_{SENSE} = 3m\Omega$, $I_{LOAD} = 1A$, $(V_{CSP} - V_{CSN}) = 3mV$, $T_A = +25^{\circ}C$, $VIPMON_ACCURACY = ((VIPMON - 214.7mV)/214.7mV) \times 100$	-3		+3	%
		$V_{CSP} = 12V$, $R_{SENSE} = 3m\Omega$, $I_{LOAD} = 3A$, $(V_{CSP} - V_{CSN}) = 9mV$, $T_A = +25^{\circ}C$, $VIPMON_ACCURACY = ((VIPMON - 644.085mV)/644.085mV) \times 100$	-1		+1	
		$V_{CSP} = 12V$, $R_{SENSE} = 3m\Omega$, $I_{LOAD} = 5A$, $(V_{CSP} - V_{CSN}) = 15mV$, $T_A = +25^{\circ}C$, $VIPMON_ACCURACY = ((VIPMON - 1.073V)/1.073V) \times 100$	-0.65		+0.65	
		$V_{CSP} = 12V$, $R_{SENSE} = 3m\Omega$, $I_{LOAD} = 8A$, $(V_{CSP} - V_{CSN}) = 24mV$, $T_A = +25^{\circ}C$, $VIPMON_ACCURACY = ((VIPMON - 1.7175V)/1.7175V) \times 100$	-0.5		+0.5	
CMRR (Note 4)	IPMON_CMRR	$V_{CSP} = 4.8V$ to $18V$	102			dB
Output Voltage Range	VIPMON_MAX	$V_{CSP} = 4.8V$ to $18V$, $-40^{\circ}C \leq T_A \leq +125^{\circ}C$	1.72			V
IPMON Voltage Clamp	VIPMON_CLMP	$V_{CSP} - V_{CSN} \geq 36mV$, $V_{CSP} = 4.8V$ to $18V$, $-40^{\circ}C \leq T_A \leq +125^{\circ}C$	2.1	2.3	2.5	V

- Note 1:** All devices are 100% production tested at $T_A = +25^{\circ}C$. Limits over temperature are guaranteed by design.
- Note 2:** Gain and offset are defined as $V_{IPMON1} = VIPMON$ with $V_{i1} = (V_{CSP} - V_{CSN}) = 3mV$, $V_{IPMON2} = VIPMON$ with $V_{i2} = (V_{CSP} - V_{CSN}) = 24mV$, $G_{IM} = (V_{IPMON2} - V_{IPMON1}) / (V_{i2} - V_{i1})$, $V_{IPMON_OS} = V_{IPMON1} - G_{IM} \times V_{i1}$.
- Note 3:** Accuracy over the entire operating range can be determined combining the specified value of the related offset and gain in the range.
- Note 4:** CMRR is calculated as:

$$V_{REF} = VIPMON \text{ with } V_{CSP} - V_{CSN} = 3mV \text{ at } V_{REF} = V_{CSP} = 12V,$$

$$V_{CM} = VIPMON \text{ with } V_{CSP} - V_{CSN} = 3mV \text{ at } 4.8V < V_{CSP} < 18V,$$

$$CMRR = 20 \times \text{LOG}(\text{ABS}((12 - V_{CSP}) / (V_{REF} - V_{CM}))) \times G_{IM},$$

where G_{IM} is the differential gain defined in the *Electrical Characteristics* table.

Typical Operating Characteristics

($V_{IN1} = V_{IN2} = 12V$, $C_{IN1} = C_{IN2} = C_{VS} = 1\mu F$, $R_{SENSE} = 3m\Omega$, unless otherwise noted.)

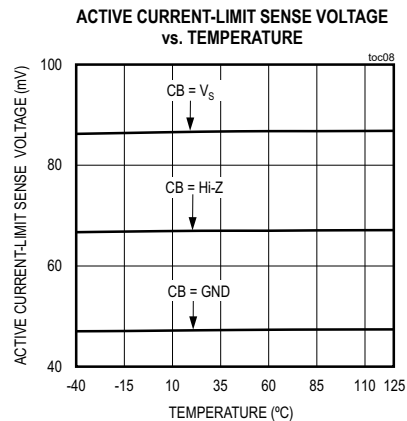
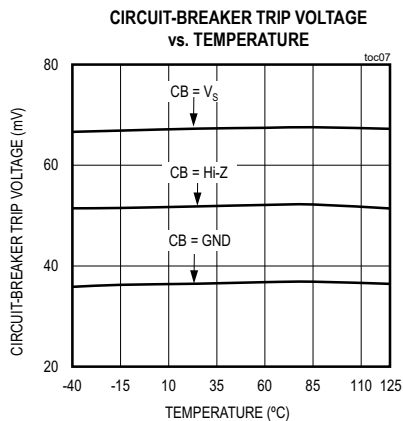
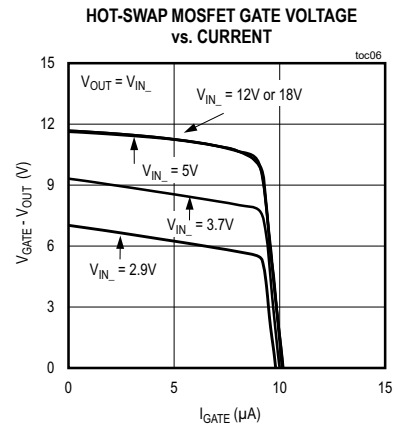
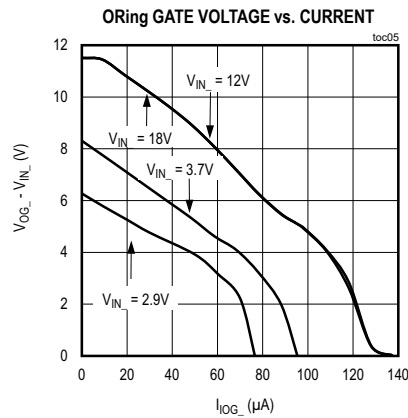
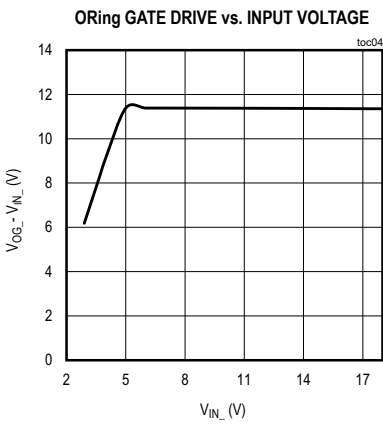
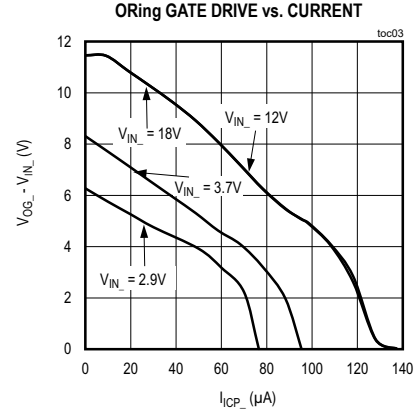
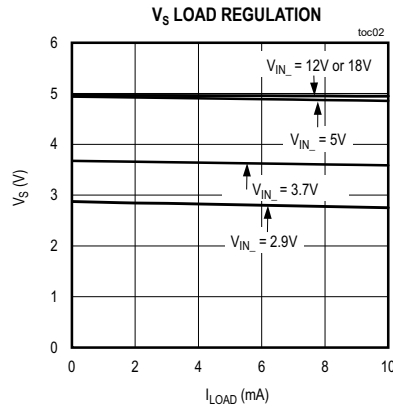
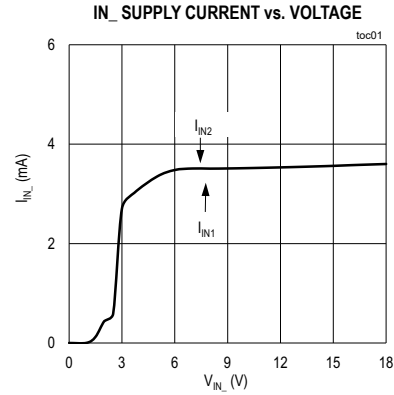

Typical Operating Characteristics (continued)

($V_{IN1} = V_{IN2} = 12V$, $C_{IN1} = C_{IN2} = C_{VS} = 1\mu F$, $R_{SENSE} = 3m\Omega$, unless otherwise noted.)

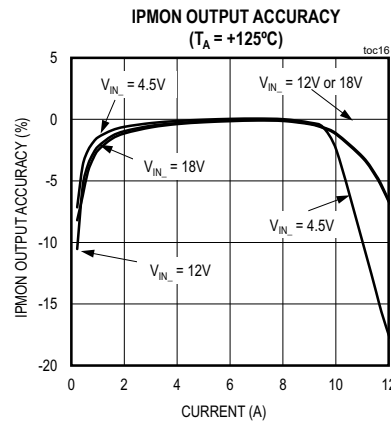
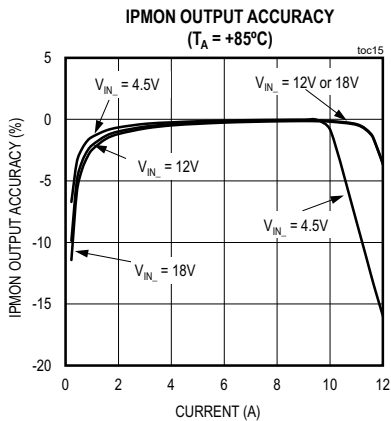
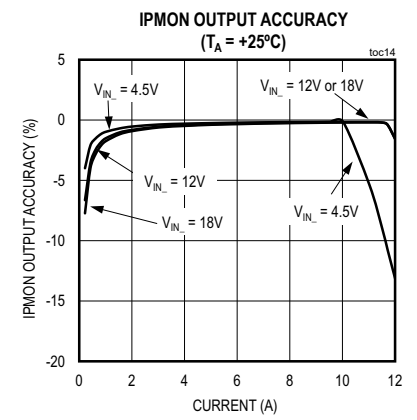
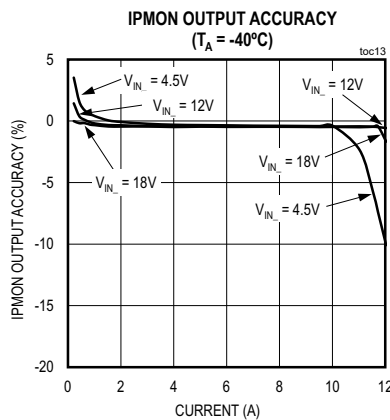
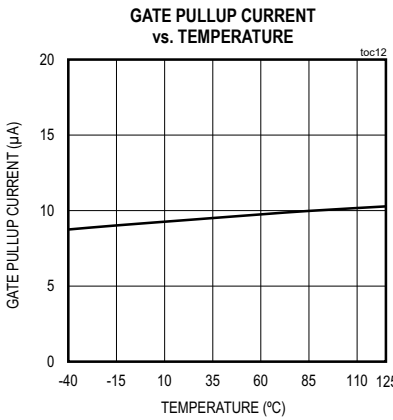
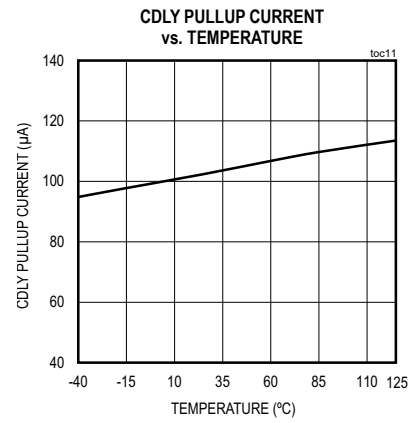
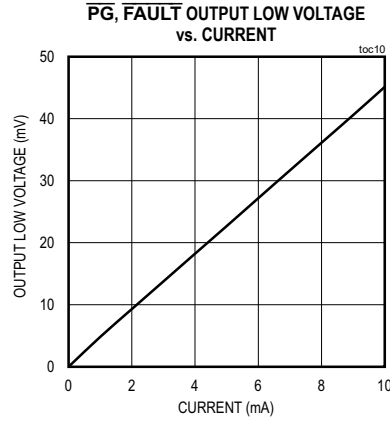
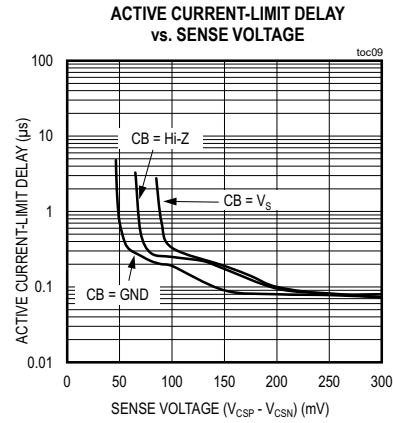

Typical Operating Characteristics (continued)

($V_{IN1} = V_{IN2} = 12V$, $C_{IN1} = C_{IN2} = C_{VS} = 1\mu F$, $R_{SENSE} = 3m\Omega$, unless otherwise noted.)

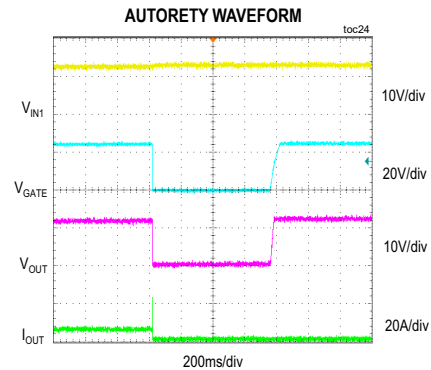
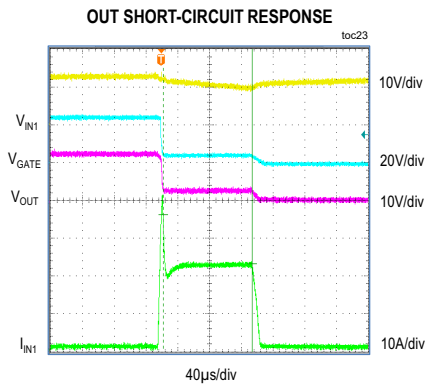
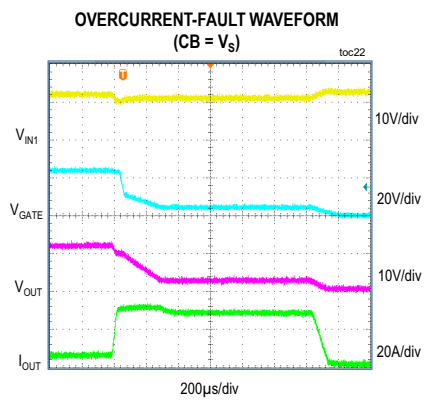
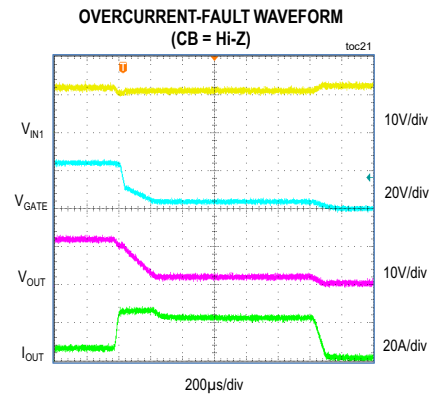
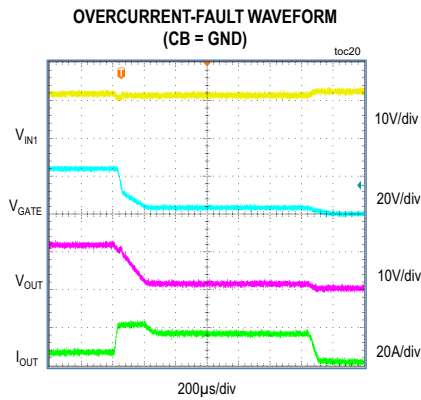
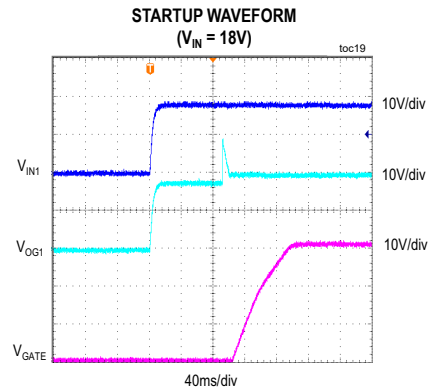
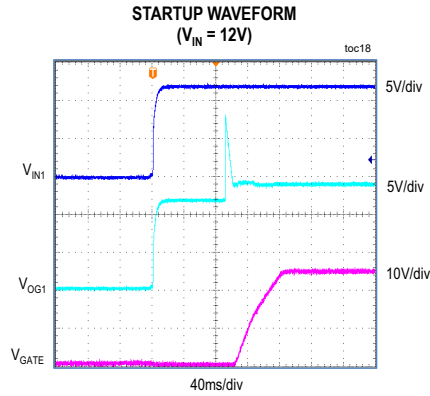
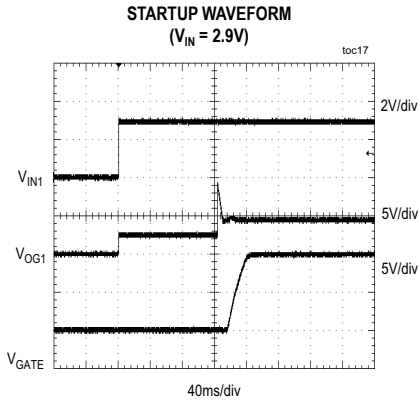

Pin Configuration

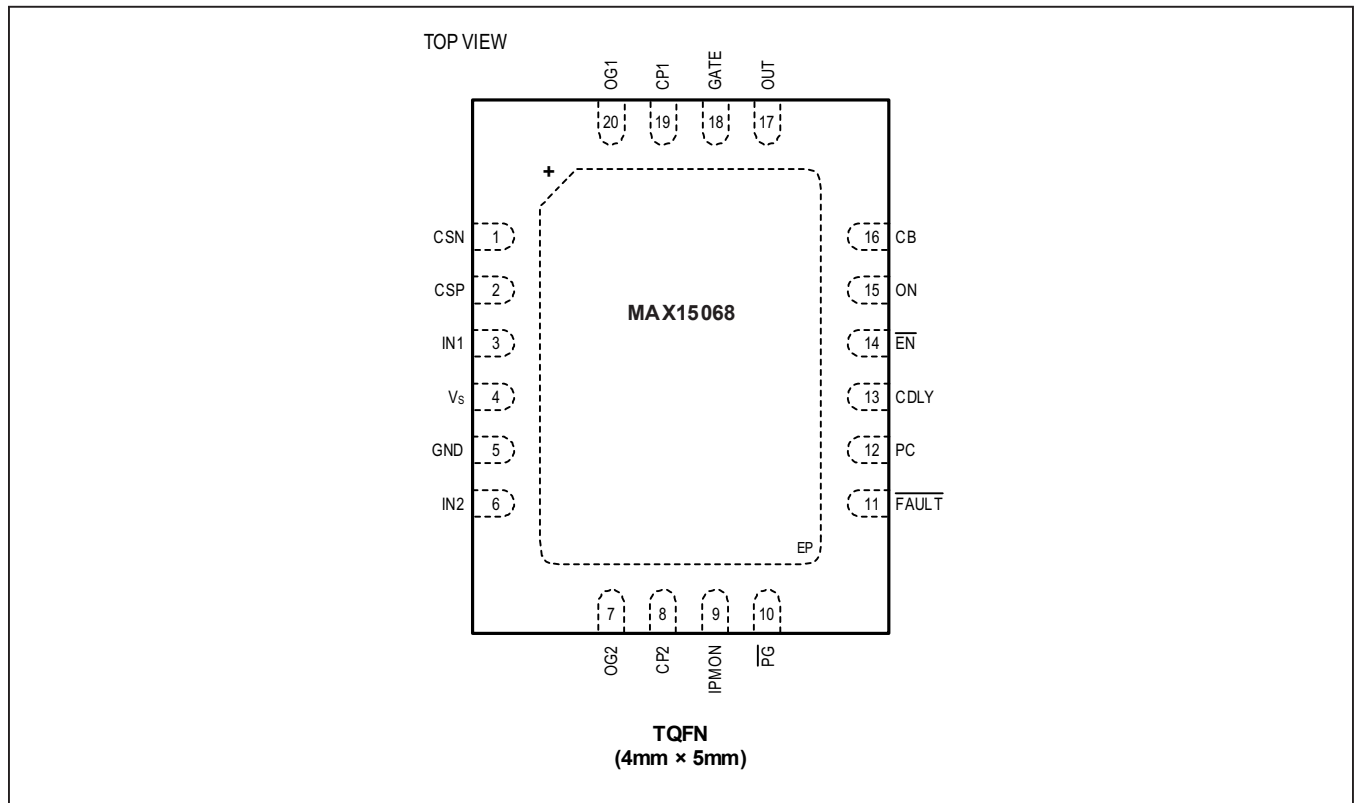

Pin Description

PIN	NAME	FUNCTION
1	CSN	Input Current Sense Negative Input
2	CSP	Input Current Sense Positive Input
3	IN1	Positive Supply 1 Input and MOSFET Gate Drive Return
4	VS	Internal Regulator Output. Bypass VS to GND with a 1µF capacitor.
5	GND	Ground
6	IN2	Positive Supply 2 Input and MOSFET Gate Drive Return
7	OG2	ORing MOSFET 2 Gate Control Output. Connect this pin to the gate of an external n-channel MOSFET for ideal diode control. The gate voltage is limited to approximately 11V above and a diode voltage below IN2. During fast turn-on, a 1A pullup switch charges OG2 from CP2. During fast turn-off, a 3A pulldown switch discharges OG2 to IN2.
8	CP2	Charge Pump 2 Output. Connect a capacitor from CP2 to IN2 pin. The value of this capacitor should be approximately 10x the gate capacitance (CISS) of the external MOSFET for ORing diode control. The charge stored on this capacitor is used to pull up the gate during a fast turn-on.
9	IPMON	Analog Current Monitor Output Signal. Connect a 560pF/6.3V ceramic capacitor from IPMON to GND.

Pin Description (continued)

PIN	NAME	FUNCTION
10	\overline{PG}	Power Status Output. Open-drain output that is normally pulled high by a 10 μ A current source to a diode below V_S . \overline{PG} can be pulled above V_S using an external pullup. \overline{PG} pulls low when the MOSFET gate drive between GATE and OUT exceeds the gate-to-source voltage of 4.2V and V_{OUT} is greater than 90% of V_{CSP} . Leave \overline{PG} unconnected if unused.
11	\overline{FAULT}	Fault Status Output. Open-drain output that is normally pulled high by a 10 μ A current source to a diode below V_S . \overline{FAULT} can be pulled above V_S using an external pullup. \overline{FAULT} pulls low when the circuit breaker is tripped after an overcurrent fault timeout. Leave \overline{FAULT} unconnected if unused.
12	PC	Priority Control Input. When low, it enables the external ideal diode MOSFET in the IN2 supply path and a high turns it off. Connect PC to an external resistive divider from IN1 to make IN1 the higher priority input supply when IN1 and IN2 are equal. Connect PC to GND if not used.
13	CDLY	Timer Capacitor Terminal. Connect a capacitor between CDLY and GND to set 12ms/ μ F duration for current limit before the external hot-swap MOSFET is turned off. The duration of the off-time is 600ms/ μ F, resulting in a 2% duty cycle.
14	\overline{EN}	Enable Input. Connect \overline{EN} to GND to enable hot-swap control. If \overline{EN} is pulled high, the hot-swap MOSFET is not allowed to turn on. A 10 μ A current source pulls up \overline{EN} to a diode below V_S . Upon \overline{EN} going low when ON is high, an internal timer provides a 100ms startup delay for debounce, after which the fault is cleared.
15	ON	On Control Input. When above 1.2V, it turns on the external hot-swap MOSFET and when below 1.1V, it turns it off. Connect ON to an external resistive divider from CSP to monitor the supply undervoltage condition. Pulling voltage of ON pin below 0.6V resets the electronic circuit breaker.
16	CB	Current-Limit Threshold Setting. Connect the CB pin to V_S , GND, or leave CB unconnected to set the circuit-breaker threshold. See Table 1 for details.
17	OUT	Load Output. Connect OUT to the source of the external hot-swap MOSFET.
18	GATE	Hot-Swap MOSFET Gate Drive Output. Connect this pin to the gate of the external n-channel MOSFET for hot-swap control. An internal 10 μ A current source charges the MOSFET gate. An internal clamp limits the gate voltage to 11V above OUT and a diode voltage below OUT. During turn-off, a 500 μ A pulldown current discharges GATE to ground. During an output short to ground, a fast 200mA pulldown current discharges GATE to OUT.
19	CP1	Charge Pump 1 Output. Connect a capacitor from CP1 to IN1 pin. The value of this capacitor should be 10x or greater than the gate capacitance of the external MOSFET for ideal diode control. The charge stored on this capacitor is used to pull up the gate during a fast turn-on.
20	OG1	ORing MOSFET 1 Gate Control Output. Connect OG1 to the gate of an external n-channel MOSFET for ideal diode control. The gate voltage is set to approximately 11V above and a diode voltage below IN1. During fast turn-on, a 1A pullup switch charges OG1 from CP1. During fast turn-off, a 3A pulldown switch discharges OG1 to IN1.
—	EP	Exposed Pad. Connect EP to the ground plane to provide a low thermal resistance path from the IC junction to the PCB. Do not use EP as the only electrical connection to GND.

Functional Diagram

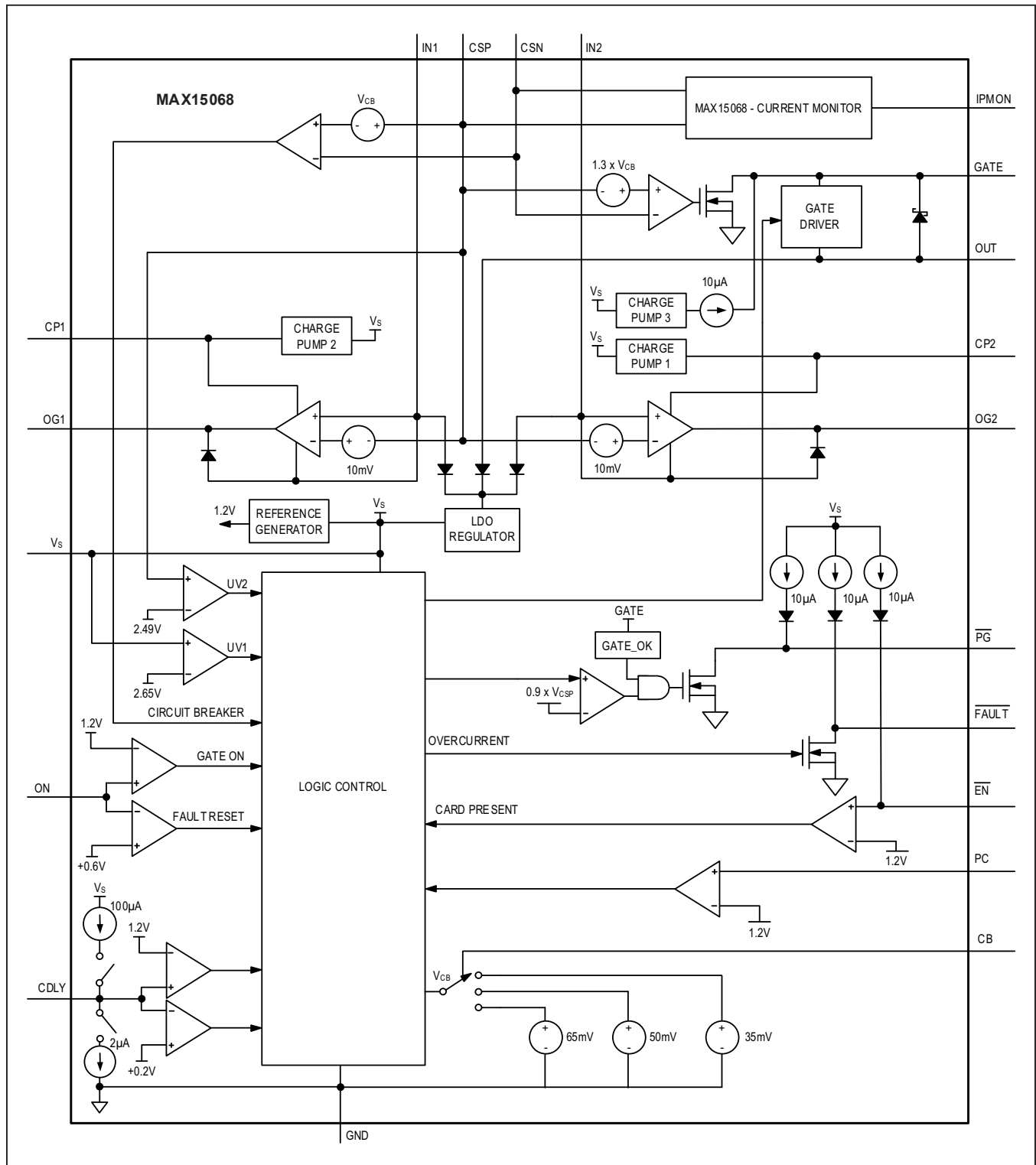

Detailed Description

Startup

When input voltage is applied to IN_{-} , CSP comes up to one diode below the higher of $IN1$ or $IN2$. The internal LDO regulator powers V_S from the higher of two inputs as well. When both V_S and CSP reach their respective UVLO thresholds, the internal charge pumps (CP1 or CP2) for the ORing controller start operating. An internal timer starts when both ON is above its threshold and \overline{EN} is below its threshold. After the timer counts 85ms, the ORing control (OG1 or OG2) begins operating. After another 15ms have elapsed, the hot-swap control (GATE) also starts operating.

ORing Control

ORing Control in Startup

As soon as the internally generated supply, V_S , rises above its undervoltage lockout threshold, the internal charge pump is allowed to charge up the CP_ pins. Because the ideal diode MOSFETs are connected in parallel as a diode-OR, the CSP pin voltage selects the highest of the supplies at the $IN1$ and $IN2$ pins. The MOSFET associated with the lower input supply voltage is turned off by the corresponding gate drive amplifier.

At power-up the CP_ and OG_ pin voltages are at the IN_{-} voltage level. CP_ starts ramping up after V_S clears its undervoltage lockout level.

If the amplifier senses a forward voltage drop greater than 80mV between IN and CSP then the OG_ pin is pulled to CP_ to quickly turn on the MOSFET. If the amplifier senses a reverse voltage drop greater than 10mV between CSP and IN_{-} , then the OG_ pin is pulled to IN_{-} to quickly turn off the MOSFET. With the ideal diode MOSFETs acting as an input supply diode-OR, the CSP pin voltage rises to the highest of the supplies at the $IN1$ and $IN2$ pins. The stored charge in an external capacitor connected between the CP_ and IN_{-} pins provides the charge needed to quickly turn on and off the ideal diode MOSFET. An internal charge pump charges the external capacitors at the CP_ pins. The OG_ pin sources current from the CP_ pin and sinks current into the IN_{-} and GND pins.

ORing MOSFET Regulation Mode

When the ideal diode MOSFET is turned on, the gate drive amplifier controls OG_ to servo the forward voltage drop ($V_{IN} - V_{CSP}$) across the MOSFET to 10mV. If the load current causes more than 10mV of voltage drop, across the FET, then the OG_ voltage rises to 11V (typ) above IN_{-} to fully enhance the MOSFET. For large output

currents, the MOSFET's gate is driven fully on and the voltage drop is equal to $I_{LOAD} \times R_{DS(ON)}$ of the MOSFET.

Hot-Swap Control

Hot-Swap in Startup

Once the output is enabled, the device provides controlled application of power to the load.

An external capacitor connected to the GATE pin allows the user to program the slew rate to a value lower than the default. During startup, a foldback current limit is active to protect the external hot-swap MOSFET to operate within the SOA (Figure 1).

An internal timer is activated to count for 70ms, which is the maximum time duration for the startup phase. The startup phase is completed when the voltage at OUT rises above the power-good threshold ($0.9 \times V_{CSP}$ typical) and hot-swap GATE to OUT voltage exceeds 4.2V even though the 70ms timeout has not yet elapsed. Once the power-good threshold is achieved, the normalized circuit-breaker threshold goes to its full value.

Programmable Speed Circuit-Breaker Response on Hot-Swap MOSFET

The device features an adjustable current limit with circuit-breaker function that protects the external MOSFETs against short circuits or excessive load current. The voltage across the external sense resistor (R_{SENSE}) is monitored by an electronic circuit breaker and active current limit amplifier (ACL). The electronic circuit breaker turns off the hot-swap MOSFET with a 500 μ A current from GATE to OUT if the voltage across the sense resistor exceeds V_{CB_TH} for longer than the fault filter delay configured at the \overline{CDLY} pin. Active current limiting begins when the sense voltage exceeds the ACL threshold V_{ACL} (ACL) (which is $1.3 \times V_{CB_TH}$). The gate of the hot-swap MOSFET is brought under control by the ACL amplifier and the output current is regulated to maintain the ACL

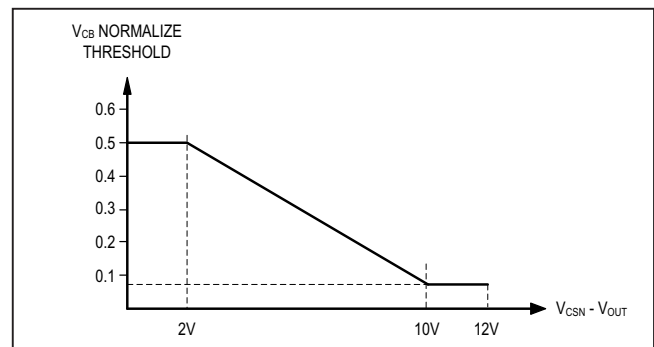

Figure 1. Inrush Current vs. Voltage Drop Across the Hot-Swap Switch During Startup Period

threshold across the sense resistor. At this point, the fault filter starts the timeout with a 100 μ A current charging the CDLY pin capacitor. If the CDLY pin voltage exceeds its threshold (1.2V), the external MOSFET is turned off and the FAULT pin pulls low.

After the hot-swap MOSFET turns off, the CDLY pin capacitor is discharged with a 2 μ A pulldown current until it reaches 0.2V. This is followed by a cool-off period of 14 timing cycles at the CDLY pin. At the end of the cool-off period and the GATE pin restarts charging up the gate of the MOSFET.

In the event of a severe short-circuit fault on the 12V output, the output current can surge very high. The device responds within 1 μ s to bring the current under control by pulling the GATE to OUT voltage down with a 200mA current. Almost immediately, the gate of the hot-swap MOSFET recovers rapidly due to the R_{GATE} and C_{GATE} network, and load current is actively limited until the electronic circuit breaker times out. Due to parasitic supply lead inductance, an input supply without any bypass capacitor may collapse during the high current surge and then spike upwards when the current is interrupted.

Programmable Circuit-Breaker Current Threshold

The device features a programmable current limit with circuit-breaker function that protects the external MOSFETs against short circuits or excessive load current. The voltage across the external sense resistor, (R_{SENSE}) is monitored by an electronic circuit breaker and active current limit (ACL) amplifier. Connect the CB pin to GND, V_S, or leave unconnected to select the circuit-breaker threshold ([Table 1](#)).

Timer (CDLY)

An external capacitor connected from the CDLY pin to GND serves as fault filtering when the supply output is in active current limit. When the voltage across the sense resistor exceeds the circuit-breaker trip threshold, CDLY pulls up with 100 μ A. Otherwise, it pulls down with 2 μ A. The fault filter times out when the 1.2V CDLY threshold is exceeded, causing the FAULT pin to pull low. The fault filter delay or circuit-breaker time delay is:

$$t_{CB} = C_{CDLY} \times 12[\text{ms}/\mu\text{F}]$$

After the circuit-breaker timeout, the CDLY pin capacitor pulls down with 2 μ A from the 1.2V CDLY threshold until it reaches 0.2V. Then it completes 14 cooling cycles consisting of the CDLY pin capacitor charging to 1.2V with a 100 μ A current and discharging to 0.2V with a 2 μ A current. At that point, the GATE pin voltage is allowed to

start up and the FAULT pin pulls high. The total cool-off time for the MOSFET after an overcurrent fault is:

$$t_{COOL} = C_{CDLY} \times 7.13[\text{s}/\mu\text{F}]$$

ORing Response in Overload Condition

During the fault condition, the ORing MOSFET remains on.

Control Inputs

ON Input

The device drives the OG_ as soon as the V_{IN1} - V_{F1} (V_{F1} is the forward voltage drop of ORing MOSFET connected to IN1) or V_{IN2} - V_{F2} (V_{F2} is the forward voltage drop of the ORing MOSFET connected to IN2) supply voltage generates a V_{ON} above the threshold voltage. An external resistive divider from CSP to ON and ground is used to set the turn-on voltage to any desired voltage from 2.9V to 5.5V. The IC turns on the corresponding ORing MOSFET and then turns on the hot-swap MOSFET when V_{ON} > 1.22V.

The device turns off the output when V_{ON} falls below V_{UV_REF} (1.22V - V_{ON_HYS}). An external resistive divider from CSP to ON and ground is used to set the undervoltage-lockout threshold to any desired level between V_{UVLO} and 18V.

Monitoring

Analog Current Monitor Output

IPMON monitors the system input current and provides the best accuracy when V_{IPMON} is less than 1.7V, or V_{SENSE} is less than 23.75mV. The IPMON signal is clamped at 2.3V, or V_{SENSE} = 32mv. For best performance, add a 560pF/6.3V ceramic capacitor between IPMON and GND.

The voltage at IPMON (V_{IPMON}) is proportional to the input current (I_{SYS}) given by the following equation:

$$V_{IPMON} = G_{IM} \times I_{SYS} \times R_{SENSE}$$

where G_{IM} = 71.565, a fixed voltage gain.

Adding a resistive voltage divider at the IPMON output ([Figure 2](#)) allows the overall V_{IPMON} gain (G) to be adjusted per the following equation:

$$G = G_{IM} \times R2/(R1+R2)$$

where R1 = 20k Ω , C1 = 560pF, and C2 = 1nF. The resistive-divider equivalent resistance R1||R2 needs to be carefully selected, as it affects accuracy due to the input bias current of the system readout.

Output Signals

Fault Status Output ($\overline{\text{FAULT}}$)

$\overline{\text{FAULT}}$ is an open-drain output that is internally pulled high by a 10 μA current source to a diode below V_S , and can be pulled above V_S using an external pullup. $\overline{\text{FAULT}}$ asserts low when the circuit breaker is tripped after an overcurrent fault timeout. Leave $\overline{\text{FAULT}}$ unconnected if unused.

Power-Good Output ($\overline{\text{PG}}$)

Internal circuitry monitors the hot-swap MOSFET gate overdrive between the GATE and OUT pins and the voltage at the OUT pin. The power-good status for the supply is reported by the $\overline{\text{PG}}$ open-drain output. It is pulled high by an external pullup resistor or the internal 10 μA pullup. The power-good output asserts low when the gate overdrive exceeds 4.2V during the GATE startup and the voltage at the OUT pin exceeds $(0.9 \times V_{\text{CSP}})$. The $\overline{\text{PG}}$ signal is delayed by 16ms once conditions for power-good are met.

Fault Management

Autoretry

When an overcurrent fault is latched after tripping the circuit breaker, the $\overline{\text{FAULT}}$ pin is asserted low. Only the hot-swap MOSFET is turned off, and the ideal diode MOSFETs are not affected. The latched fault is reset automatically after a cool-off timing cycle as described in the [Timer \(CDLY\)](#) section. At the end of the cool-off

period, the fault latch is cleared and $\overline{\text{FAULT}}$ pulls high. The GATE pin voltage is allowed to start up and turn on the hot-swap MOSFET. If the output short persists, the supply powers up into a short with active current limiting until the circuit breaker times out and $\overline{\text{FAULT}}$ again pulls low. A new cool-off cycle begins with CDLY ramping down with a 2 μA current. The whole process repeats itself until the output short is removed. Since t_{CB} and t_{COOL} are a function of CDLY capacitance, C_{CDLY} , the autoretry duty cycle is equal to 0.1%, irrespective of C_{CDLY} .

Applications Information

Prioritizing Supplies with PC

[Figure 2](#) shows an ORing application where a resistive divider connected from IN1 at the PC pin controls the turn-on of the ORing MOSFET, MD2, in the IN2 supply path. When the IN1 supply voltage falls below 4.5V, it turns on the ORing MOSFET, MD2, causing the ORing output to be switched from the main 5.0V supply at IN1 to the auxiliary 5.0V supply at IN2. This configuration permits the load to be supplied from a lower IN1 supply as compared to IN2 until IN1 falls below the MD2 turn-on threshold. The threshold value used should not allow the IN1 supply to be operated at more than one diode voltage below IN2. Otherwise, MD2 conducts through the MOSFET's body diode. The resistive divider connected from CSP at the ON pin provides the undervoltage threshold of 2.6V for the ORing output supply.

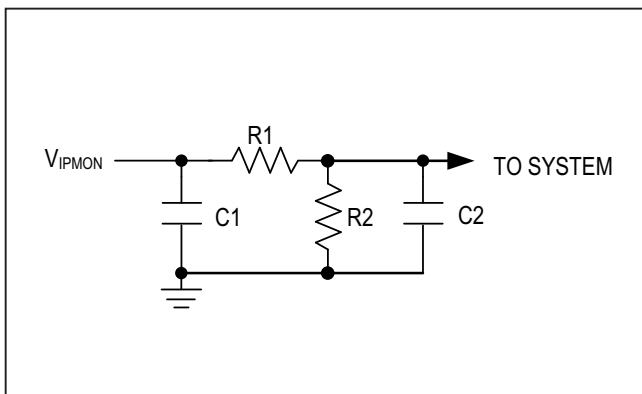

Figure 2. External RC Network to Adjust V_{IPMON}

Table 1. Circuit-Breaker Threshold Programming

CB PIN CONNECTION	CIRCUIT-BREAKER THRESHOLD ($V_{\text{CSP}} - V_{\text{CSN}}$) [mV]
CB = GND	35
CB = Hi-Z (unconnected)	50
CB = V_S	65

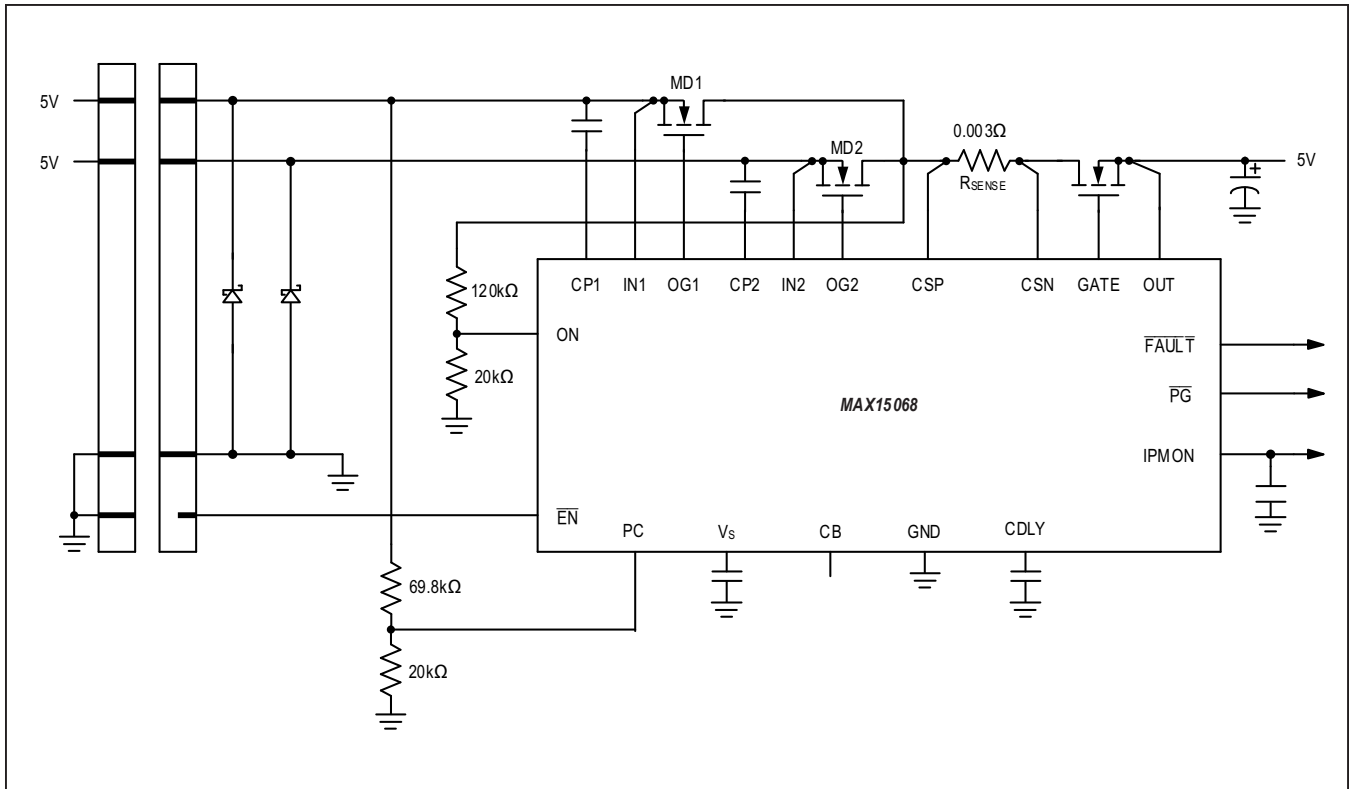
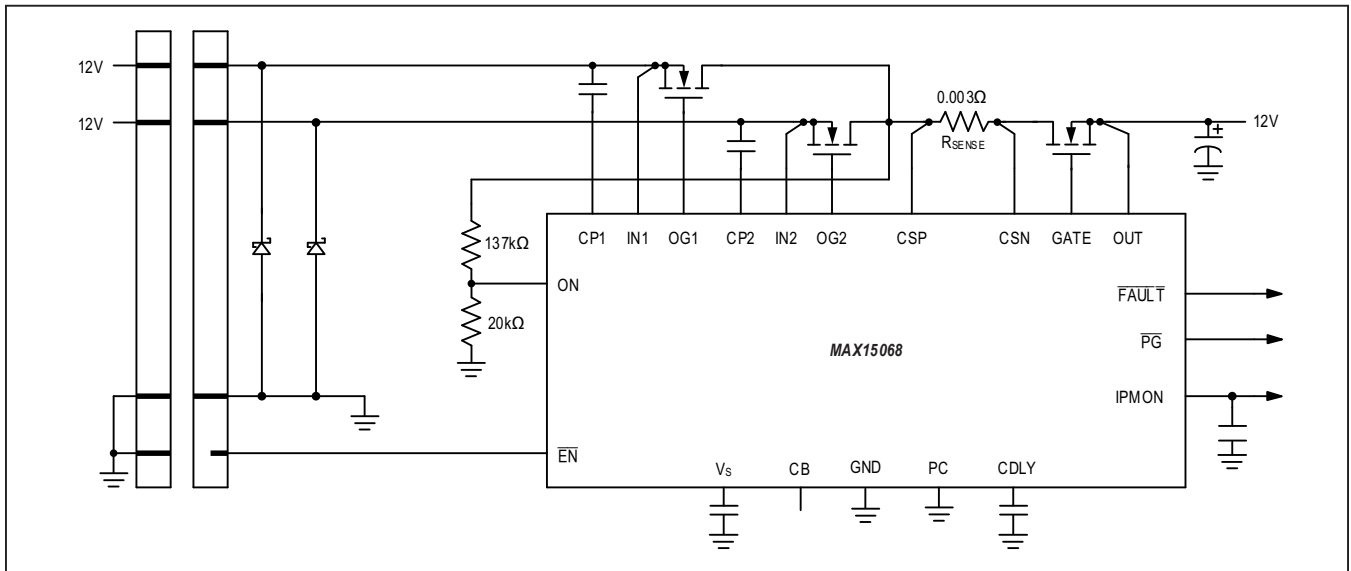

Figure 3. Plug-in Card IN1 Supply Controls the IN2 Supply Turn-On Through the PC Pin

Typical Application Circuit



Ordering Information

PART	OPERATING RANGE	FUNCTION	TEMP RANGE	PIN-PACKAGE
MAX15068ATP+	2.9V to 18V	Autoretry, Current Monitor	-40°C to +125°C	20 TQFN-EP*

+Denotes a lead(Pb)-free/RoHS-compliant package.
 *EP = Exposed pad.

Chip Information

PROCESS: BiCMOS

Revision History

REVISION NUMBER	REVISION DATE	DESCRIPTION	PAGES CHANGED
0	12/13	Initial release	—
1	2/16	Customer test spec changes: Updated <i>General Description, Benefits and Features, Electrical Characteristics</i> table; replaced TOC2–TOC6, TOC17, and changed TOC13–TOC16 titles in <i>Typical Operating Characteristics</i> section; updated IPMON pin 9 function in <i>Pin Description</i> table; updated 2nd equation in <i>Timer (CDLY)</i> section; replaced <i>Analog Current Monitor Output</i> section, adding a new Figure 2; renumbered and replaced new Figure 3 and replaced <i>Typical Application Circuit</i> ; updated operating range in <i>Ordering Information</i> table	1–9, 13–16
2	5/18	Updated the <i>Package Information</i> table.	2
3	10/19	Corrected errors, eliminated redundant descriptions, and clarified descriptions. Removed overbar on PC pin name to match functionality.	1–17

For pricing, delivery, and ordering information, please visit Maxim Integrated's online storefront at <https://www.maximintegrated.com/en/storefront/storefront.html>.

Maxim Integrated cannot assume responsibility for use of any circuitry other than circuitry entirely embodied in a Maxim Integrated product. No circuit patent licenses are implied. Maxim Integrated reserves the right to change the circuitry and specifications without notice at any time. The parametric values (min and max limits) shown in the *Electrical Characteristics* table are guaranteed. Other parametric values quoted in this data sheet are provided for guidance.

Looking for pricing, stock, or lifecycle information?

Click below to explore more details on WIN SOURCE:

 [View MAX15068ATP+ on WIN SOURCE](#)

 [Analog Devices Inc. Information](#)

Optimize Your Supply Chain with WIN SOURCE Solutions

-  Global Sourcing Solution
-  Obsolete Management
-  Cost Control Management
-  Shortage Management
-  Alternative Solution
-  Excess Inventory Management